



Revision 2.0

# **LBP654C Series**

# **Service Manual**

# Introduction

## Important Notices

### Application

This manual has been issued by Canon Inc. for qualified persons to learn technical theory, installation, maintenance, and repair of products.

This manual covers all localities where the products are sold. For this reason, there may be information in this manual that does not apply to your locality.

### Corrections

This manual may contain technical inaccuracies or typographical errors due to improvements or changes in products. When changes occur in applicable products or in the contents of this manual, Canon will release technical information as the need arises. In the event of major changes in the contents of this manual over a long or short period, Canon will issue a new edition of this manual.

The following paragraph does not apply to any countries where such provisions are inconsistent with local law.

### Trademarks

The product names and company names used in this manual are the registered trademarks of the individual companies.

### Copyright

The copyright of this document belongs to Canon Inc. This document may not be copied, reproduced or translated into another language, in whole or in part, without the prior consent of Canon Inc.







Copyright CANON INC. 2017















### Caution

Use of this manual should be strictly supervised to avoid disclosure of confidential information.



### Explanation of Symbols

The following symbols are used throughout this Service Manual.

Symbols	Explanation	Symbols	Explanation
	Check.		Remove the claw.
	Check visually.		Insert the claw.
	Check a sound.		Push the part.

Symbols	Explanation	Symbols	Explanation
	Disconnect the connector.		Connect the power cable.
	Connect the connector.		Disconnect the power cable.
	Remove the cable/wire from the cable guide or wire saddle.		Turn on the power.
	Install the cable/wire to the cable guide or wire saddle.		Turn off the power.
	Remove the screw.		Loosen the screw.
	Install the screw.		Tighten the screw.
	Cleaning is needed.		Measurement is needed.

The following rules apply throughout this Service Manual:

- Each chapter contains sections explaining the purpose of specific functions and the relationship between electrical and mechanical systems with reference to the timing of operation.  
In the diagrams,  represents the path of mechanical drive; where a signal name accompanies the symbol, the arrow  indicates the direction of the electric signal.  
The expression "turn on the power" means flipping on the power switch, closing the front door, and closing the delivery unit door, which results in supplying the machine with power.
- In the digital circuits, '1' is used to indicate that the voltage level of a given signal is "High", while '0' is used to indicate "Low". (The voltage value, however, differs from circuit to circuit.) In addition, the asterisk (\*) as in "DRMD\*" indicates that the DRMD signal goes on when '0'.  
In practically all cases, the internal mechanisms of a microprocessor cannot be checked in the field. Therefore, the operations of the microprocessors used in the machines are not discussed: they are explained in terms of from sensors to the input of the DC controller PCB and from the output of the DC controller PCB to the loads.

The descriptions in this Service Manual are subject to change without notice for product improvement or other purposes, and major changes will be communicated in the form of Service Information bulletins.

All service persons are expected to have a good understanding of the contents of this Service Manual and all relevant Service Information bulletins and be able to identify and isolate faults in the machine.

# Contents

<b>Safety Precautions.....</b>	<b>1</b>
Laser Safety.....	2
How to Handle the Laser Scanner Unit.....	2
Toner Safety.....	2
About Toner.....	2
Handling Adhered Toner.....	2
Notes When Handling a Lithium Battery.....	3
Notes on Assembly/Disassembly.....	3
<b>1. Product Overview.....</b>	<b>4</b>
Product Lineup.....	5
Host Machine.....	5
Option.....	5
Features.....	5
Specifications.....	6
Specifications of Host Machine.....	6
Paper type.....	7
Paper size.....	7
Parts Name.....	9
External view.....	9
Cross Section View.....	11
Control Panel.....	12
<b>2. Technical Explanation (Device).....</b>	<b>13</b>
Basic Configuration.....	14
Functional Configuration.....	14
Laser Exposure System.....	15
Functional Configuration.....	15
Failure Detection.....	15
Controller System.....	17
Configuration/Function.....	17
Main Controller PCB.....	18
Motor Control.....	18
Door Open Detection.....	19
Fan Control.....	19
Low-voltage Power Supply Control.....	19
Protection Function.....	20
Power-saving Mode.....	20
Image Formation System.....	22
Major Components.....	22
Image Formation Process.....	22
High Voltage Power Supply Control.....	22
Image Stabilization Control.....	23
Cartridge.....	25

Pickup Feed System.....	28
Overview.....	28
Parts Configuration.....	29
Drive Configuration.....	30
Layout of Sensors.....	31
Lifter Control.....	31
Cassette Detection.....	32
Cassette Pickup Control.....	33
Multi-purpose Tray Pickup Control.....	33
Skew Correction.....	34
Arch Control.....	35
Delivery Tray Full Detection.....	36
Jam Detection.....	36
Fixing System.....	38
Functional Configuration.....	38
Fixing Temperature Control.....	38
Protection Function.....	39
Fixing Assembly Failure Detection.....	39
<b>3. Technical Explanation (System).....</b>	<b>41</b>
Overview of System Management.....	42
Version Upgrade.....	43
Function Overview.....	43
Version Upgrade Using UST.....	44
Version Upgrade via Internet.....	44
Version Upgrade Using USB.....	45
Setting Information Export/Import Function (DCM).....	47
Overview.....	47
Import/Export Procedure from [Settings/Registration] of Remote UI.....	49
Procedure for Exporting/Importing Service Mode Setting Information.....	52
List of Items Which Can Be Imported.....	53
Monitoring Function (e-Maintenance/imageWARE Remote).....	60
Overview of System.....	60
Servicing Notes.....	61
Setting Procedure.....	61
Maintenance.....	62
<b>4. Periodical Service.....</b>	<b>64</b>
Periodically Replaced Parts.....	65
Consumable Parts.....	66
Periodical Services.....	67
<b>5. Parts Replacement and Cleaning.....</b>	<b>68</b>
List of Parts.....	69
Major Units.....	69
Layout Drawing of Electrical Components.....	71
External Cover System.....	75
Removing the Toner Cartridge.....	75
Removing the Left Cover.....	76

Removing the Right Cover.....	78
Removing the Rear Cover Unit.....	80
Removing the Cartridge Cover .....	80
Removing the Cartridge Tray.....	82
Removing the Control Panel Lower Cover.....	84
Removing the Upper Cover Unit .....	85
<b>Controller System.....</b>	<b>87</b>
Removing the Controller Cover .....	87
Removing the Wireless LAN PCB (Wi-Fi model only).....	87
Removing the Wireless LAN Support Plate (Wi-Fi model only).....	88
Removing the Main Controller PCB.....	88
Removing the Main Controller Support Plate.....	89
Removing the Engine Controller PCB.....	89
Removing the Low Voltage Power Supply Unit.....	90
Removing the Control Panel Unit.....	92
Removing the USB PCB.....	94
Removing the Cartridge Fan.....	95
Removing the Power Supply Fan.....	96
Removing the Driver PCB.....	97
Removing the Power Switch Unit.....	98
Removing the Environment Sensor.....	98
Removing the Memory Relay PCB.....	99
<b>Laser Exposure System.....</b>	<b>101</b>
Removing the Laser Scanner Unit.....	101
<b>Image Formation System.....</b>	<b>107</b>
Removing the Secondary Transfer Roller.....	107
Removing the Secondary Transfer Feed Unit.....	108
Removing the ITB Unit.....	109
Removing the Color Displacement Density Sensor Unit.....	111
Removing the Developing Motor.....	112
Removing the Drum Motor.....	114
<b>Fixing System.....</b>	<b>116</b>
Removing the Fixing Assembly.....	116
Removing the Fixing Power Supply Unit.....	118
Removing the Fixing Motor.....	119
<b>Pickup Feed Delivery System.....</b>	<b>120</b>
Removing the Cassette Pickup Roller/Feed Roller Unit .....	120
Removing the Cassette Separation Roller Unit .....	121
Removing the Duplex Reverse Drive Unit.....	122
Removing the Pickup Motor.....	123
Removing the Re-Pickup Unit.....	124
Removing the Lifter Drive Unit.....	125
Removing the Cassette Pickup Unit.....	127
Removing the Multi-purpose Tray Pickup Roller.....	129
Removing the Multi-purpose Tray Separation Pad.....	130
Removing the Registration Unit.....	131

## **6. Adjustment..... 135**

Adjustment at Parts Replacement.....	136
After Replacing the Control Panel.....	136

After Replacing the ITB Unit.....	136
After Replacing the Color Displacement Density Sensor Unit.....	136
Engine Controller PCB.....	136
Main Controller PCB.....	136
<b>7. Troubleshooting.....</b>	<b>138</b>
Test Print.....	139
Engine Test Print.....	139
Controller test print.....	140
Cartridge Log Report.....	150
Troubleshooting Items.....	152
Recurring faulty image.....	152
Confirming nip width.....	152
Debug Log.....	154
Function Overview.....	154
Conditions for collecting logs.....	154
Collection procedure.....	154
<b>8. Error/Jam/Alarm.....</b>	<b>156</b>
Overview.....	157
Error/Jam/Alarm Log indication.....	157
JAM/ERR LOG REPORT.....	158
Location Code.....	159
Pickup Position Code.....	159
Error Code.....	160
Error Code Details.....	160
Jam Code.....	166
Jam Code Details.....	166
Alarm Code.....	168
Alarm Code Details.....	168
<b>9. Service Mode.....</b>	<b>169</b>
Overview.....	170
Entering Service Mode.....	170
Remote UI Service Mode.....	170
COPIER (Service mode for copier).....	172
DISPLAY (State display mode).....	172
ADJUST (Adjustment mode).....	173
FUNCTION (Operation / inspection mode).....	179
OPTION (Specification setting mode).....	191
COUNTER (Counter mode).....	199
TESTMODE (Service mode for test print, operation check, etc.).....	203
PRINT (Print test mode).....	203
<b>10. Installation.....</b>	<b>207</b>
MiCARD Attachment Kit-B1.....	208
Points to Note at Installation.....	208
Installation Outline Drawing.....	208

Checking the Contents..... 208  
Check Item When Turning OFF the Main Power.....208  
Installation Procedure..... 208

**APPENDICES.....213**

Service Tools.....214  
    Special Tools..... 214  
    Solvents and Oil List..... 214  
General Circuit Diagram.....215  
Backup Data List..... 217  
Soft counter specifications..... 219



# Safety Precautions

Laser Safety.....	2
How to Handle the Laser Scanner Unit .....	2
Toner Safety.....	2
Notes When Handling a Lithium Battery.....	3
Notes on Assembly/Disassembly.....	3

## Laser Safety

Since radiation emitted inside this machine is completely confined with protective housings and external covers, the laser beam cannot escape from the machine during any phase of normal use by users.

Therefore, this machine is classified as a Class 1 laser product under the international standard IEC60825-1 that is regarded as safe during normal use.

## How to Handle the Laser Scanner Unit

This machine is classified as a Class 1 laser product.

However, the laser scanner unit contains source of Class 3B laser beam and exposure to the beam may cause eye injuries.

Therefore, be sure not to disassemble the laser scanner unit. No adjustment can be made to the laser scanner unit in the machine in the field.

The label shown in the following figure is affixed on the laser scanner unit.

Dieses Gerät ist der Klasse 1 der Laserprodukte zugeordnet.

Allerdings enthält die Laserscannereinheit eine Laserstrahlquelle der Klasse 3B, die Augenschäden verursachen kann, wenn man in diesen Strahl blickt.

Deshalb darf die Laserscannereinheit nicht zerlegt werden. An der Laserscannereinheit kann keine Justage vor Ort vorgenommen werden.

Der in folgendem Bild dargestellte Aufkleber ist auf der Laserscannereinheit angebracht.

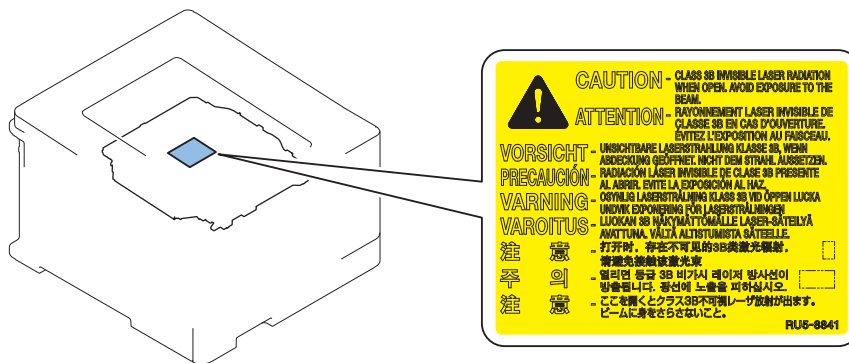

## Toner Safety

### About Toner

Toner is a nontoxic matter composed of plastic, iron and a trace of pigments.

#### **CAUTION:**

Never throw toner in flames to avoid explosion.

### Handling Adhered Toner

- Use dry tissue paper to wipe off toner adhered to skin or clothes and wash in water.
- Never use warm water for cleaning up toner to prevent toner particles from being gelated to soak into fibers permanently.
- Toner particles are reactive with vinyl polymers. Avoid contacting these materials.

## Notes When Handling a Lithium Battery

Dispose of used batteries according to the instructions.

**⚠ CAUTION:**

Risk of explosion if battery is replaced by an incorrect type.

The following warnings are given to comply with Safety Principles (EN60950-1).

**⚠ CAUTION:**

Wenn mit dem falschen Typ ausgewechselt, besteht Explosionsgefahr.  
Gebrauchte Batterien gemäß der Anleitung beseitigen.

**警告**

如果更換不正確之電池型式會有爆炸的風險  
請依製造商說明書處理用過之電池

## Notes on Assembly/Disassembly

Follow the items below to assemble/disassemble the device.

1. Disconnect the power plug to avoid any potential dangers during assembling/disassembling works.
2. If not specially instructed, reverse the order of disassembly to reinstall.
3. Ensure to use the right screw type (length, diameter, etc.) at the right position when assembling.
4. To keep electric conduction, binding screws with washers are used to attach the grounding wire and the varistor. Ensure to use the right screw type when assembling.
5. Unless it is specially needed, do not operate the device with some parts removed.
6. Never remove the paint-locked screws when disassembling.



# Product Overview

Product Lineup.....	5
Specifications.....	6
Parts Name.....	9

## Product Lineup

### Host Machine



	LBP654Cdw / LBP654Cx
Print	Yes
Remote UI	Yes
2-sided printing	Yes
Control Panel	5 inch Touch Panel
NFC	Yes
Backup of counter	Yes
MEAP	-
Network	Yes
Wireless LAN	Yes

#### PDL

	LBP654Cdw / LBP654Cx
PS	Yes
PCL	Yes

### Option

Name	Description
Cassette Feeding Module-AF1	550 sheets (80 g/m2) of paper can be placed
MiCARD Attachment Kit-B1	Attachment kit for MiCARD Reader Except KOR model
Barcode Printing Kit-E1	

### Features

#### Middle Class A4/LTR Color Laser SFP

1. Improved Control Panel operability  
Improved operability by adopting the Large 5 inch Color Touch Panel.
2. Support for mobile print  
Printing from smartphones, tablets and PCs via an application such as Apple AirPrint, proprietary application, Google Cloud Print and Mopria Print becomes available.
3. Support for wireless LAN  
Communication via mobile device and wireless LAN becomes available by connecting a wireless LAN router to the network to which this machine is connected.
4. NFC (Near Field Communication)  
Printing can be performed by touching a mobile device where Canon PRINT Business is installed.

# Specifications

## Specifications of Host Machine

Item	Specification / Function
Device Installation	Desktop
Photoreceptor	OPC drum (φ24)
Light exposure method	Laser beam exposure
Charging method	Roller charging
Developing method	Contact development
Transfer method	Primary transfer: Sequential 4 colors transfer to Intermediate Transfer Belt Secondary transfer: 4-color batch transfer onto the transfer material by the Transfer Roller
Separation method	Curvature separation
Cassette paper feed	Simple separation retard
Drum cleaning method	Cleaning blade
Transfer cleaning method	Cleaning brush and roller
Fixing method	On-demand fixing
Paper delivery method	Face-down
Toner level sensor	Mounted
Toner type	Non-magnetic one-component toner
Toner supply method	All-in-one cartridge (drum + toner)
Toner save mode	N/A
Warm-up Time *1	13 seconds or less
Recovery Time *2	Approx. 6.1 seconds
Print resolution	600 x 600 dpi
First print time	Color: Approx. 8.6 seconds(A4), Approx. 8.5 seconds(LTR) B&W: Approx. 8.3 seconds(A4), Approx. 8.1 seconds(LTR)
Print Speed *3	At 1-sided printing: • Color/B&W: Approx. 27 sheets/min.(A4), Approx. 28 sheets/min.(LTR) At 2-sided printing: • Color/B&W: Approx. 21.9 sheets/min.(A4), Approx. 23.1 sheets/min.(LTR)
Available paper type for cassette	Thin paper, Recycled paper, Color paper, Plain paper, Heavy paper, Coated paper, Label, Envelope (Refer to "Paper type" on page 7)
Available paper type for Multi-purpose Tray	Thin paper, Recycled paper, Color paper, Plain paper, Heavy paper, Coated paper, Label, Envelope (Refer to "Paper type" on page 7)
Available paper size in cassette	A4, B5, A5, LGL, LTR, STMT, EXEC, OFFICIO, B-OFFICIO, M-OFFICIO, GLTR, GLGL, FLS, AFLS, indLGL, K16, Postcard, Envelopes (COM10, Monarch, Nagagata 3, Yougatanaga 3, C5, DL), Custom Paper Size (Refer to "Paper size" on page 7)
Multi-purpose tray paper size	A4, B5, A5, LGL, LTR, STMT, EXEC, OFFICIO, B-OFFICIO, M-OFFICIO, GLTR, GLGL, FLS, AFLS, indLGL, K16, Envelopes (COM10, Monarch, Nagagata 3, Yougatanaga 3, C5, DL), Custom Paper Size (Refer to "Paper size" on page 7)
Cassette capacity	Cassette: 250 sheets (60 to 90 g/m <sup>2</sup> ) Option: 550 sheets (60 to 90 g/m <sup>2</sup> )
Multi-purpose Tray capacity	50 sheets (60 to 90 g/m <sup>2</sup> )
Delivery tray stacking capacity *4	150 sheets (75 g/m <sup>2</sup> )
Automatic 2-sided	Available (A4, B5, LGL, LTR, EXEC, FLS)
Memory capacity	1 GB
Sleep mode	Available
Allowable environmental temperature	10 to 30 deg C
Allowable humidity	20 to 80% in relative humidity (no condensation)
Power rating	Rated input voltage: 120 V system: 120 to 127 V (60Hz) 200 V system: 220 to 240 V (50/60Hz)

Item	Specification / Function
Maximum power consumption	1500 W or lower
Average power at operation	120 V : Approx. 480 W 230 V : Approx. 510 W
Average power at standby	120 V : Approx. 20.0 W 230 V : Approx. 17.6 W
Average power at sleep mode	Approx. 1.0 W
Power consumption at Main Power Switch OFF	0.3 W or lower
Dimensions (W x D x H)	476 × 469 × 379 mm
Weight (Excluding toner cartridges)	Approx. 21.0 kg

\*1 : Warm-up time is an interval between when the machine is turned ON and when the main screen appears on the display. Warm-up time may vary depending on the use conditions and environment of the machine.

\*2 : Time for recovery from sleep to standby.

\*3 : The print speed may become lower depending on the settings such as output resolution, paper size, type, orientation, and number of sheets printed. In the case of 2-sided printing, 1 page on the front side and 1 page on the back side are output as 1 sheet.

\*4 : The actual stack capacity varies depending on the site environment and the type of paper used.

## Paper type

(Yes: Pickup possible -: Pickup not possible)

Type of paper		Paper settings in this machine	Standard Cassette/ Cassette Feeding Module-AF1 (option)	Multi-purpose Tray	Auto 2-sided printing
Thin paper	60 to 70 g/m2	Thin 1	Yes	Yes	Yes
	60 g/m2	Thin 2 *1	Yes	Yes	Yes
	52 to 59 g/m2	Thin 3	Yes	-	-
Recycled	60 to 75 g/m2	Recycled 1	Yes	Yes	Yes
	71 to 82 g/m2	Recycled 2	Yes	Yes	Yes
Color	71 to 82 g/m2	Color	Yes	Yes	Yes
Plain	71 to 82 g/m2	Plain 1	Yes	Yes	Yes
	83 to 90 g/m2	Plain 2	Yes	Yes	Yes
Heavy paper	91 to 119 g/m2	Heavy 1	Yes	Yes	Yes
	120 to 128 g/m2	Heavy 2	Yes	Yes	Yes
	129 to 163 g/m2	Heavy 3	Yes	Yes	Yes
Coated	100 to 120 g/m2	Coated 1	Yes	Yes	Yes
	121 to 150 g/m2	Coated 2	Yes	Yes	Yes
	151 to 200 g/m2	Coated 3	Yes	Yes	Yes
Label paper		Label paper	Yes	Yes	-
Envelope (Nagagata 3, Yougatanaga 3, C5)		Envelope 1	Yes	Yes	-
Envelope (COM10, Monarch, DL)		Envelope 2	Yes	Yes	-

\*1: When the paper of 60 g/m2 is curled while <Thin 1> is set, select <Thin 2>.

## Paper size

(Yes: Pickup possible -: Pickup not possible)

Paper size		Standard Cassette/ Cassette Feeding Mod- ule-AF1 (option)	Multi-purpose Tray	Auto 2-sided printing
A4	210.0 mm x 297.0 mm	Yes	Yes	Yes
B5	182.0 mm x 257.0 mm	Yes	Yes	Yes
A5	148.0 mm x 210.0 mm	Yes	Yes	-
LGL	215.9 mm x 355.6 mm	Yes	Yes	Yes
LTR	215.9 mm x 279.4 mm	Yes	Yes	Yes
STMT	139.7 mm x 215.9 mm	Yes	Yes	-
EXEC	184.2 mm x 266.7 mm	Yes	Yes	Yes
OFFICIO*4	215.9 mm x 317.5 mm	Yes	Yes	Yes
B-OFFICIO*4	216 mm x 355 mm	Yes	Yes	Yes
M-OFFICIO*4	216 mm x 341 mm	Yes	Yes	Yes
G-LTR*4	203.2 mm x 266.7 mm	Yes	Yes	Yes
G-LGL*4	203.2 mm x 330.2 mm	Yes	Yes	Yes
FLSC	215.9 mm x 330.2 mm	Yes	Yes	Yes
AFLS*4	206 mm x 338 mm	Yes	Yes	Yes
Indian LGL*4	215.0 mm x 345.0 mm	Yes	Yes	-
Envelope No.10 (COM10)	104.7 mm x 241.3 mm	Yes	Yes	-
Envelope Monarch	98.4 mm x 190.5 mm	Yes	Yes	-
Envelope C5	162.0 mm x 229.0 mm	Yes	Yes	-
Envelope DL	110.0 mm x 220.0 mm	Yes	Yes	-
Custom paper	-	Yes *1	Yes *2	Yes *3

\*1: 100 × 148 mm to 215.9 × 355.6 mm

\*2: 676.2 × 127 mm to 215.9 × 355.6 mm

\*3: 176 × 250 mm to 215.9 × 355.6 mm

\*4: Only when the user-defined size is configured on the driver



## Parts Name

### External view

#### Front side of the machine

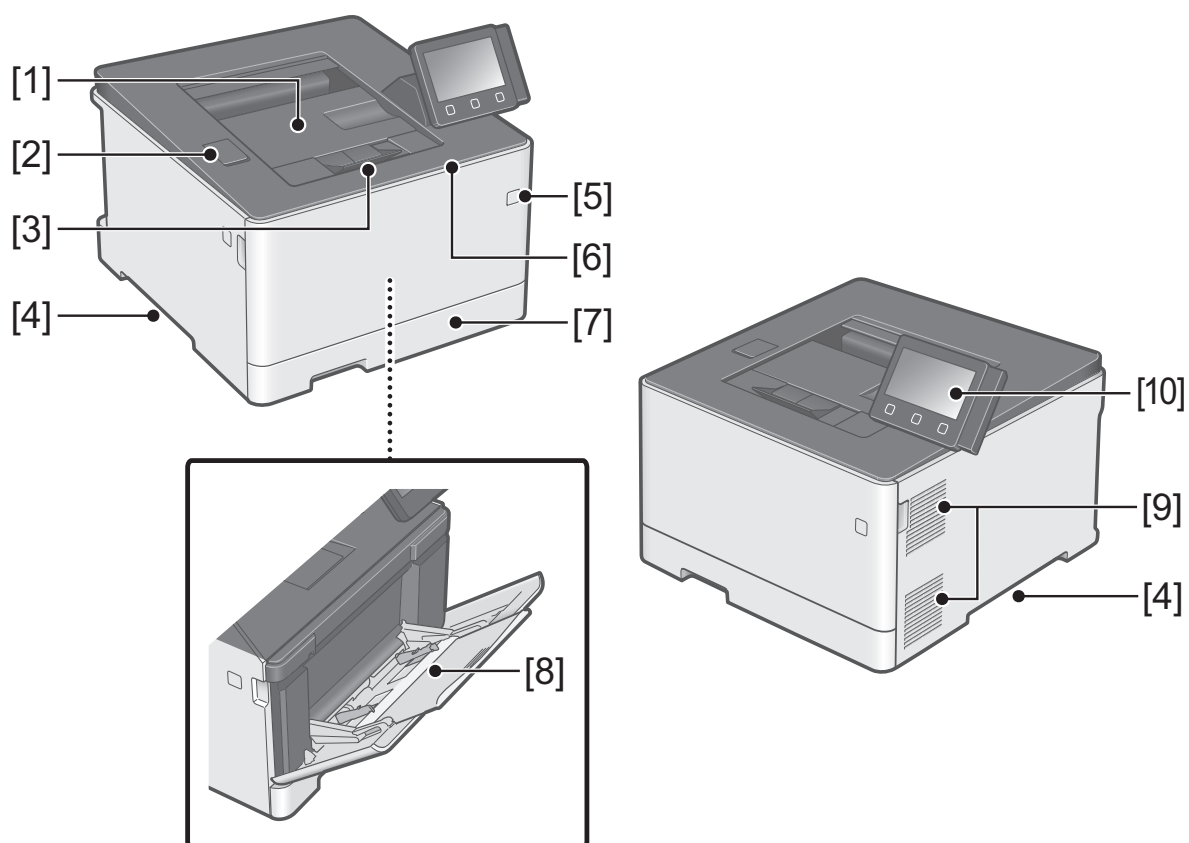

No.	Name	No.	Name
1	Delivery Tray	6	Front Cover
2	USB port (for USB device)	7	Pickup Cassette
3	Delivery Stopper	8	Multi-purpose Tray
4	Handle for carrying	9	Ventilation hole
5	Power Switch	10	Control Panel

■ Rear side of the machine

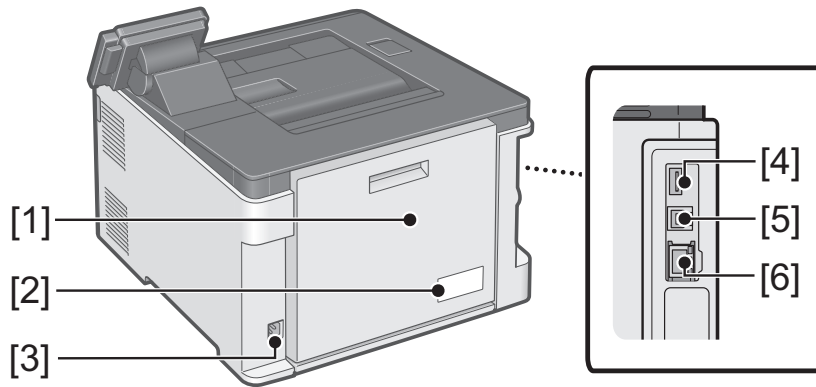

No.	Name
1	Rear Cover
2	Rating name plate label
3	Power Socket
4	USB port (for USB device)
5	USB port (for PC)
6	LAN Port

■ Inside of the host machine

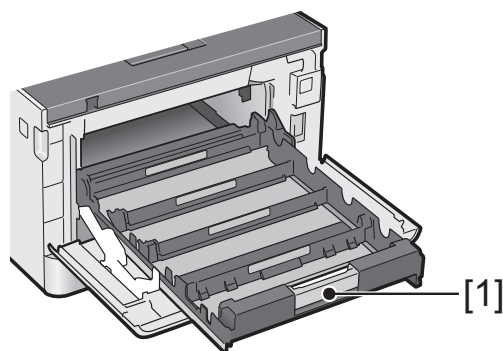

No.	Name
1	Toner Cartridge Tray

## Cross Section View

### ■ Host machine

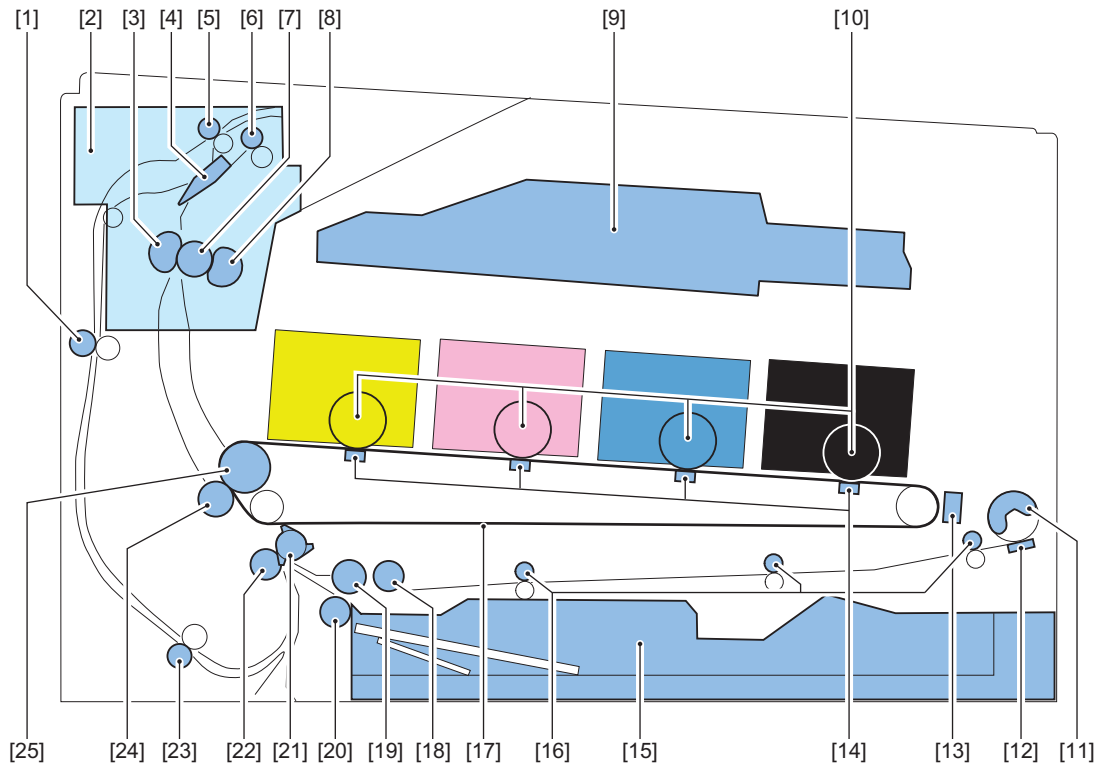

No.	Name	No.	Name
[1]	Duplex Feed Roller	[14]	Primary Transfer Brush
[2]	Fixing Assembly	[15]	Cassette
[3]	Pressure Film	[16]	Multi-purpose Tray Feed Roller
[4]	Duplex Flapper	[17]	ITB
[5]	Duplex Reverse Roller	[18]	Cassette Pickup Roller
[6]	Delivery Roller	[19]	Cassette Feed Roller
[7]	Fixing Roller	[20]	Cassette Separation Roller
[8]	Fixing Film	[21]	Registration Shutter
[9]	Laser Scanner Unit	[22]	Registration Roller
[10]	Photosensitive Drum	[23]	Duplex Re-pickup Roller
[11]	Multi-purpose Tray Pickup Roller	[24]	Secondary Transfer Roller
[12]	Multi-purpose Tray Separation Pad	[25]	ITB Drive Roller
[13]	Color Displacement/Density Sensor		

## Control Panel

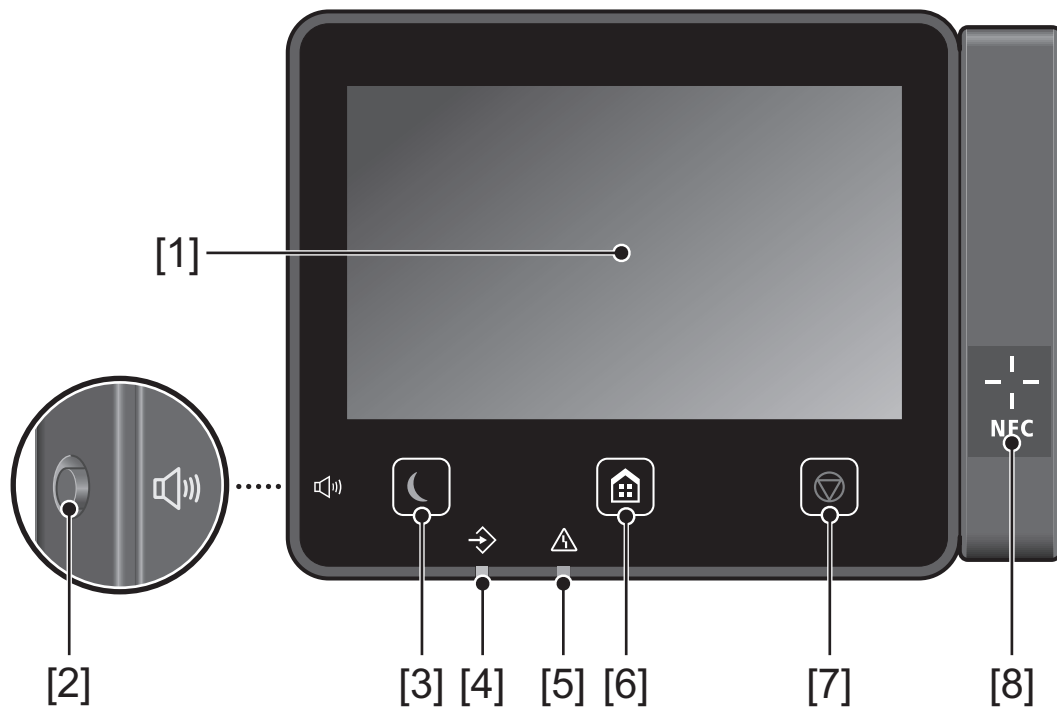

No.	Name
1	Display
2	Volume key
3	Energy Saver key
4	Data Lamp
5	Error Lamp
6	Home key
7	Stop key
8	NFC (Near Field Communication) mark



## Technical Explanation (Device)

Basic Configuration.....	14
Laser Exposure System.....	15
Controller System.....	17
Image Formation System.....	22
Pickup Feed System.....	28
Fixing System.....	38

## Basic Configuration

### Functional Configuration

#### Description

This machine is roughly composed of the following five blocks.

- Laser Exposure System
- Controller System
- Image Formation System
- Pickup Feed System
- Fixing System

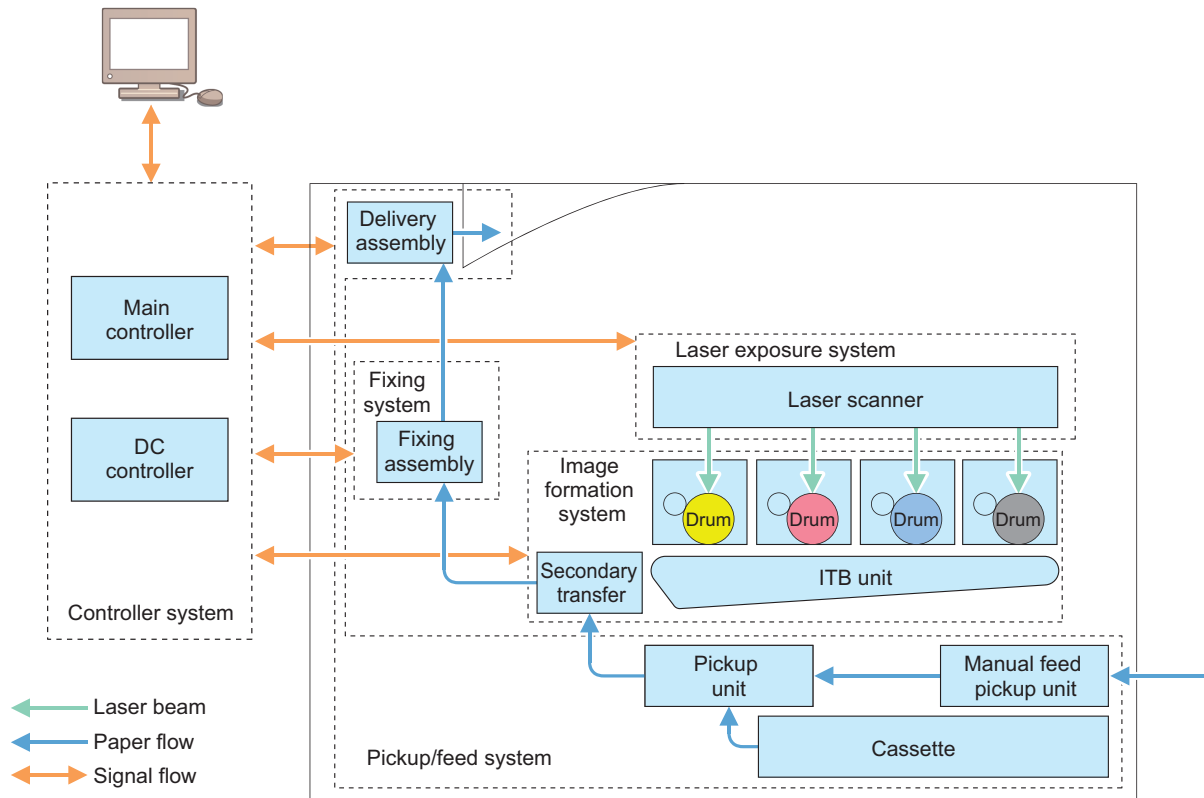

# Laser Exposure System

## Functional Configuration

### Overview

The Laser Exposure system irradiates the Photosensitive Drum with a laser to form a latent image on it according to the video signal sent from the Main Controller.

### Description

The Laser Scanner Unit consists of the Laser Unit and the Scanner Motor Unit, and is controlled by the signal input from the DC Controller.

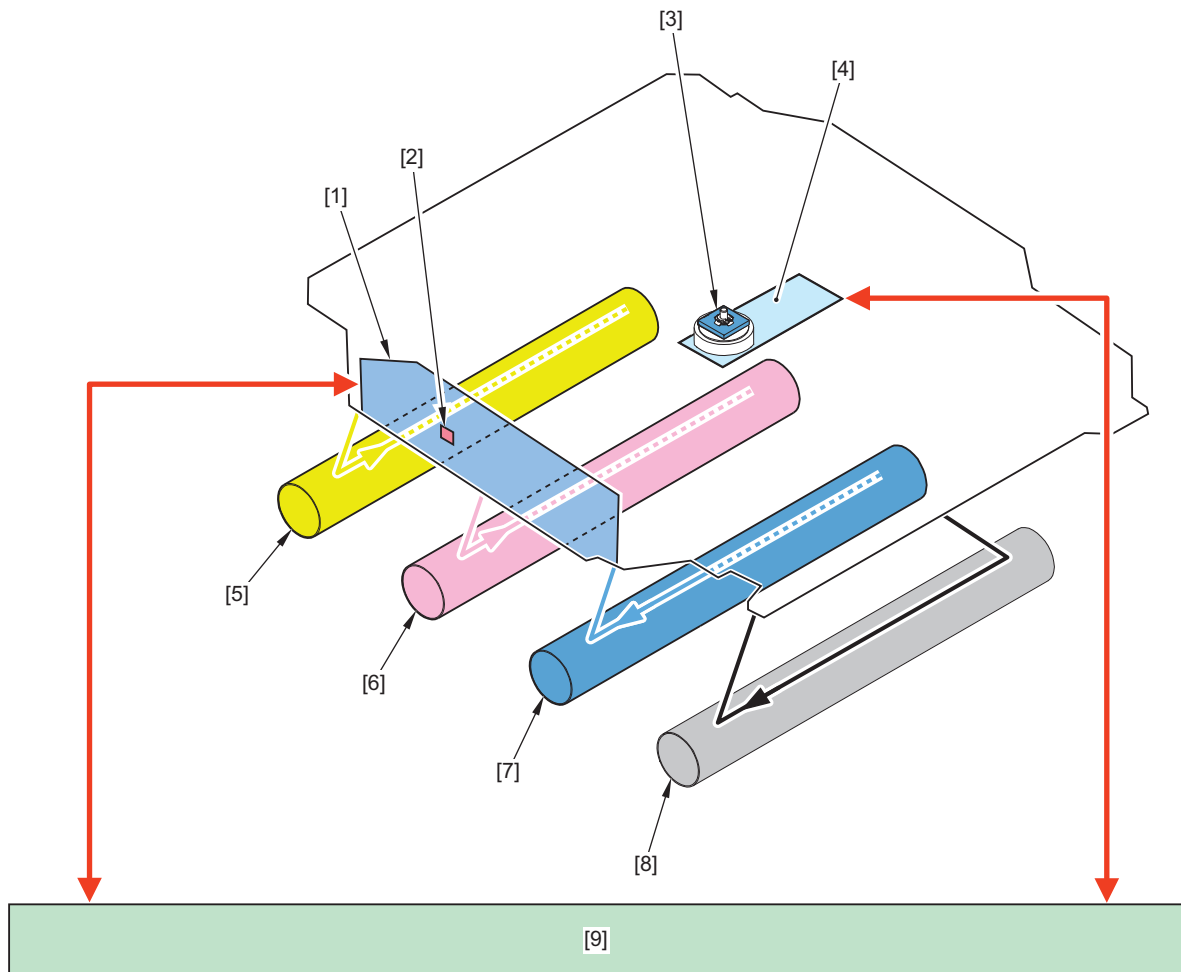

No.	Name	No.	Name
[1]	Laser Unit	[6]	Photosensitive Drum (M)
[2]	BD Sensor	[7]	Photosensitive Drum (C)
[3]	Scanner Mirror	[8]	Photosensitive Drum (Bk)
[4]	Scanner Motor Unit	[9]	DC Controller
[5]	Photosensitive Drum (Y)	-	-

## Failure Detection

### Overview

The DC Controller detects the following failures in the Laser Scanner Unit.

- Scanner area failure
- Scanner Motor startup failure

## Description

### Scanner area failure detection

If an error in any of the Scanner Motor, Laser Driver, or BD detection in the scanner area is detected, an error code is notified.

### Scanner Motor startup failure detection

If the scanner does not start although a specified period of time has elapsed after the Scanner Motor is driven, an error code is notified.

## Error Code

E100: Scanner area failure

- E100-0000: Yellow scanner area failure
- E100-0001: Magenta scanner area failure
- E100-0002: Cyan scanner area failure
- E100-0003: Black scanner area failure

E110: Scanner Motor startup failure

- E110-0000: Primary Pseudo BD correction failure



## Controller System

### Configuration/Function

#### Description

This product is mainly controlled by the main and DC controllers.

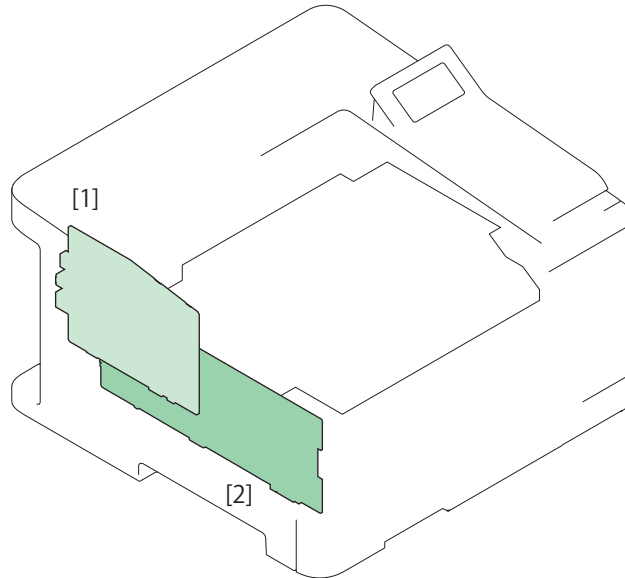

No.	Parts name	Role
[1]	Main Controller PCB	Provides controls on the system, image processing, network and maintain various setting values.
[2]	Engine Controller PCB *1	Provides controls on printer, laser, high-voltage PCBs, I/O, etc. and maintain setting values.

\*1: The engine controller PCB consists of it by a high voltage power supply circuit and a DC controller circuit.

## Main Controller PCB

### Description

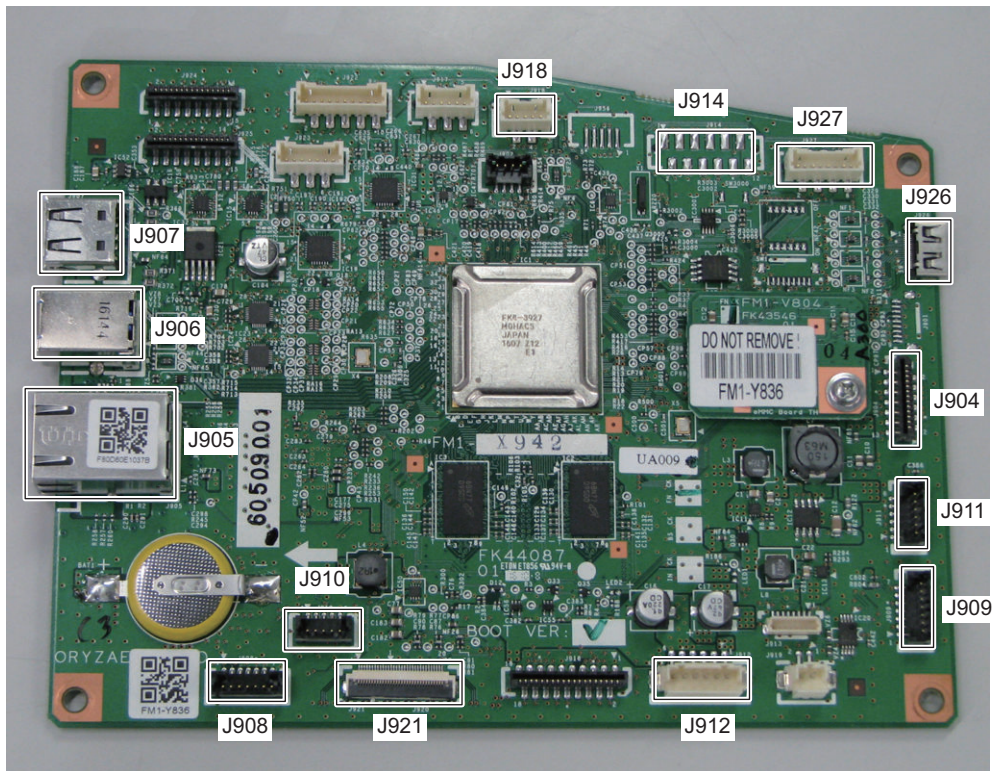

Jack	Function	Jack	Function
J904	Wireless LAN PCB I/F	J911	Memory PCB I/F
J905	LAN I/F	J912	Engine Controller PCB I/F
J906	USB TypeB	J914	5-line Control Panel PCB I/F
J907	USB TypeA	J918	USB 2.0 Relay PCB I/F
J908	CC-VI (OP)	J921	Engine Controller PCB I/F
J909	Serial No PCB I/F	J926	5-inch Touch Panel PCB I/F
J910	New card reader (OP)	J927	5-inch Touch Panel I/F

## Motor Control

### Overview

This machine uses motors for paper feed and image formation.

### Description

Name	Symbol	Drive parts	Failure Detection
Pickup Motor	M1	Multi-purpose Tray Pickup Roller, Multi-purpose Tray Feed Roller, Cassette Pickup Roller, Cassette Feed Roller, Registration Roller, Duplex Feed Roller*, Duplex Re-pickup Roller*, and lifting up the cassette	None
Drum Motor	M2	Photosensitive Drum and ITB	Yes
Developing Motor	M3	Developing Roller and engagement/disengagement of the Developing Roller	Yes
Fixing Motor	M4	Fixing Roller, Delivery Roller, Duplex Reverse Roller*, and engagement/disengagement of the Pressure Film/Fixing Roller/Fixing Film Pressure	Yes
Scanner Motor	M10	Scanner Mirror	None

\*: Duplex models only

## Door Open Detection

### Overview

This machine uses the Door Open Sensor to detect whether the door is opened or closed.

### Description

Sensor name	Symbol	Role
Front Cover Sensor	SW1	To detect whether the Front Cover is opened or closed.
Rear Cover Sensor	( Inside the Engine Controller PCB )	To detect whether the Rear Cover is opened or closed.

When door open is detected by this sensor, the DC Controller stops drive of the motors and the solenoids.

## Fan Control

### Overview

This machine uses a fan for preventing temperature rising inside the machine and for cooling the delivered paper.

### Description

Name	Sym- bol	Cooling area	Type	Speed
Power Supply Fan	FM1	Area around Low Voltage Power Supply	Suction	Variable (full speed/middle speed/low speed/ very low speed)
Cartridge Fan	FM2	Around the cartridge and Fixing Assembly	Suction	Variable (full speed/half speed)

## Low-voltage Power Supply Control

### Overview

This circuit converts the AC voltage to DC power supply and provides it to each load.

### Description

The following shows a block diagram of the low voltage power supply and fixing power supply .

- Low voltage power supply: Generates the DC power supply needed inside the printer.
- Fixing power supply: Provides AC power supply to the low voltage power supply and controls the fixing heater temperature of the Fixing Assembly.

The low voltage power supply starts to operate when the AC power supply is connected to the inlet. The AC power supply is converted to +24 V, which is the DC power supply required by the printer, and +3.3 V.

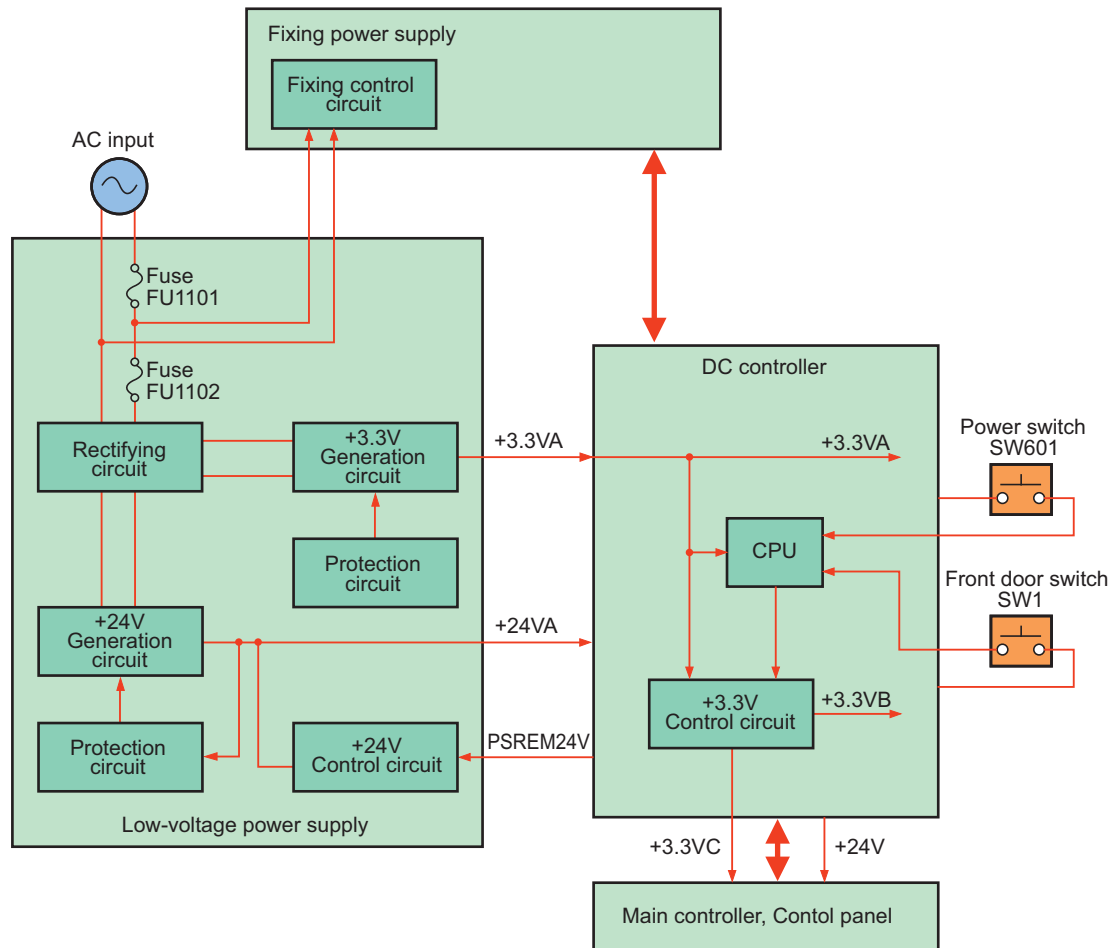

## Protection Function

### Overview

This machine has a protection function against overcurrent and overvoltage.

### Description

If overcurrent or abnormal voltage occurs due to a trouble, the DC voltage is automatically cut off to prevent damage to the Power Supply PCBs.

When no DC voltage is output from the Low Voltage Power Supply Assembly, it is possible that the protection function has been activated. Therefore, turn OFF the Power Switch, disconnect the AC Power Supply Cord from the inlet, and then fix the trouble before turning ON the Power Switch again.

#### NOTE:

Leave the machine as it is for approx. 5 minutes after disconnecting the cord from the inlet. There are cases where electric charge remains in the electrolytic capacitor on the primary side of the Power Supply PCB, and time for releasing the electric charge is needed.

## Power-saving Mode

### Overview

Power-saving mode is a function that reduces the printer power consumption.

Description

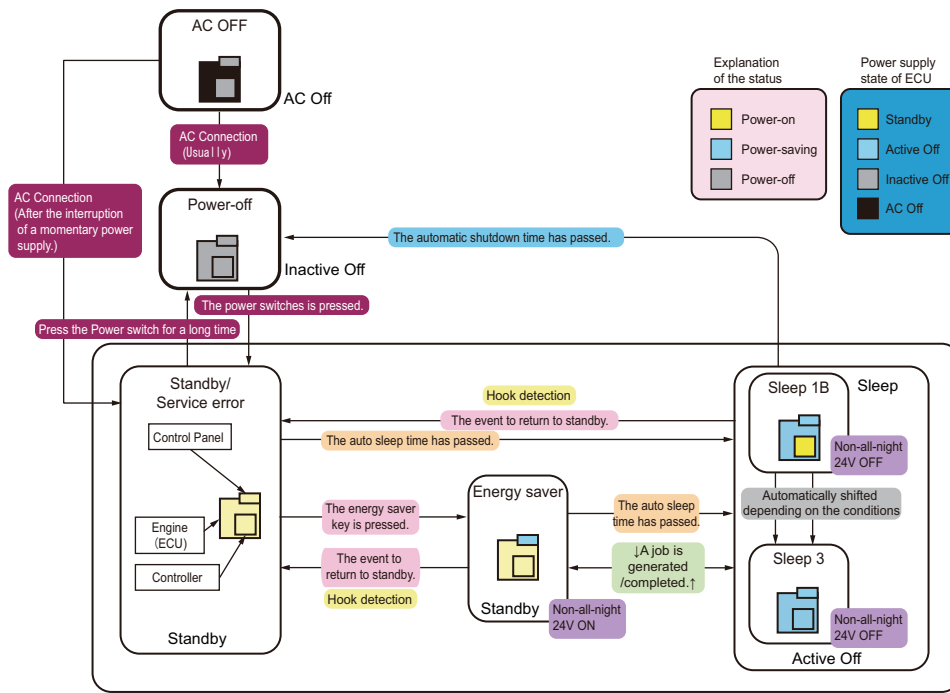

Engine (ECU) Power state	CNT All-night 3.3 V	CNT Non-all-night 24 V	ECU CPU power supply	Remarks
Standby	ON	ON	ON	Standby/Energy saving
Active Off	ON	OFF	ON	Sleep 1B/Sleep 3
Inactive Off	OFF	OFF	ON	AC applied

The low voltage power supply stops supplying power from the +24V generation circuit when it receives a power-saving transition mode signal (REM24V) from the DC Controller.

# Image Formation System

## Major Components

### Description

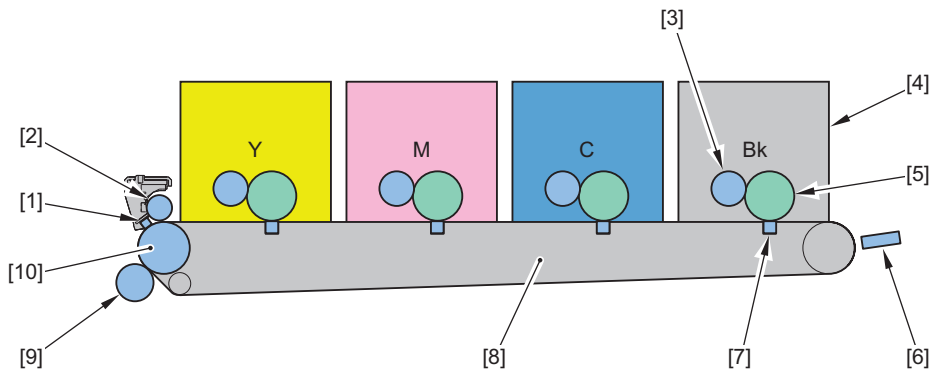

No.	Name	No.	Name
[1]	ITB Cleaning Brush	[6]	Color Displacement/Density Sensor
[2]	ITB Cleaning Roller	[7]	Primary Transfer Pad
[3]	Developing Cylinder	[8]	ITB Unit
[4]	Toner Cartridge	[9]	Secondary Transfer Roller
[5]	Photosensitive Drum	[10]	ITB Drive Roller

## Image Formation Process

### Description

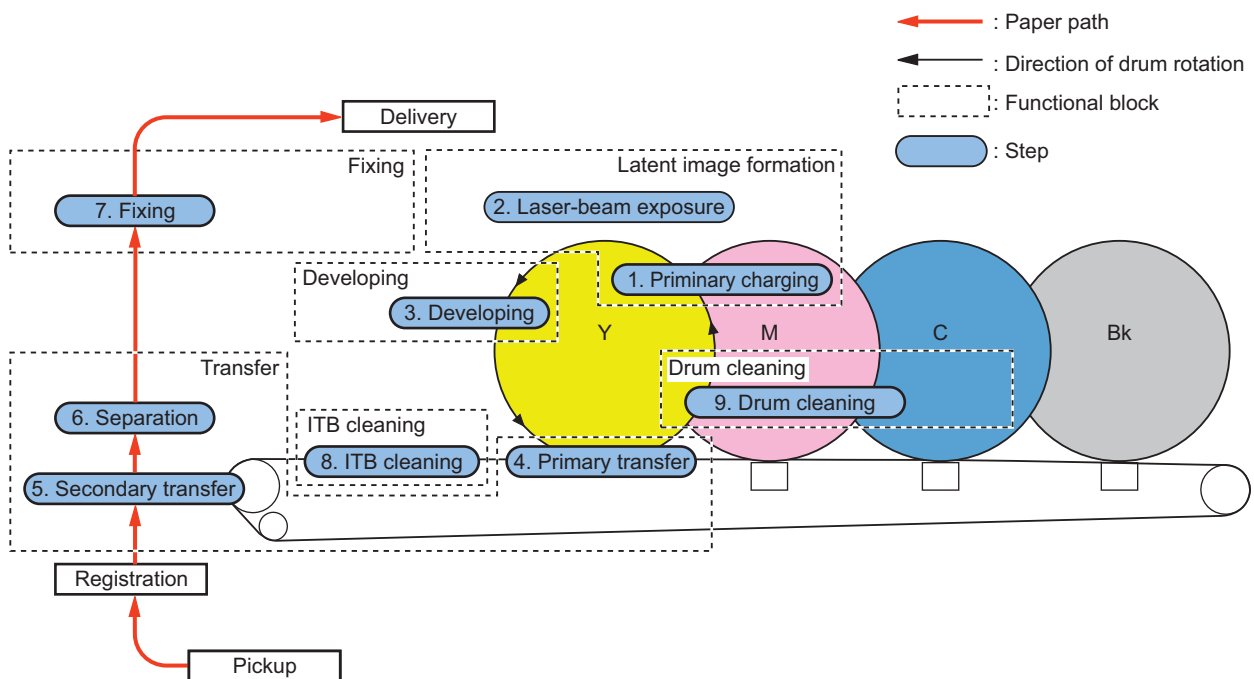

## High Voltage Power Supply Control

### Description

The High Voltage Power Supply applies high voltage biases to the following:

- Static Eliminator

- Primary Charging Roller (inside the cartridge)
- Developing Cylinder (inside the cartridge)
- Primary Transfer Pad
- Secondary Transfer Roller
- ITB Cleaning Assembly

The high voltage biases are generated by the DC Controller controlling the High Voltage Power Supply.

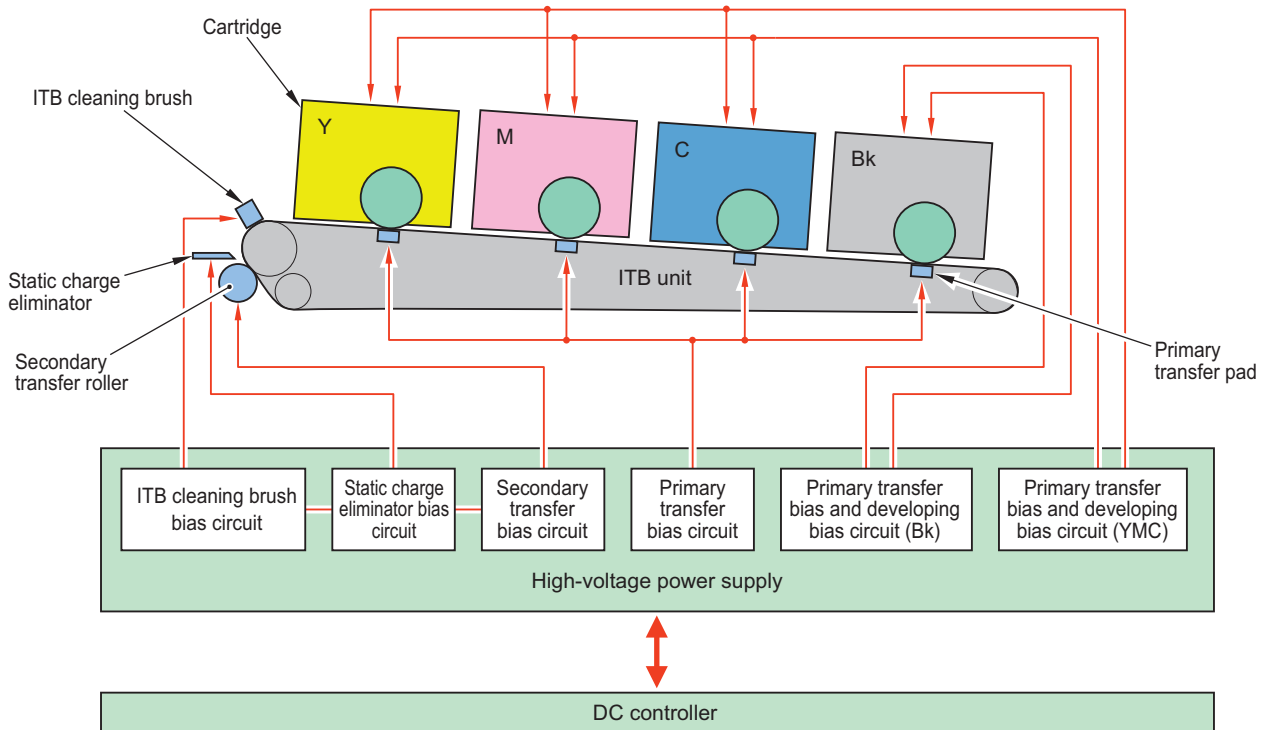

## Image Stabilization Control

### Overview

Image stabilization control is performed in order to prevent image failure due to change of the environment, deterioration of the Photosensitive Drum, deterioration of the toner, etc. and to ensure stable printing.

- Image Density Correction Control (D-max control)
- Image Gradation Correction Control (D-half control)
- Color Displacement Correction Control
- Auto Gradation Adjustment Control

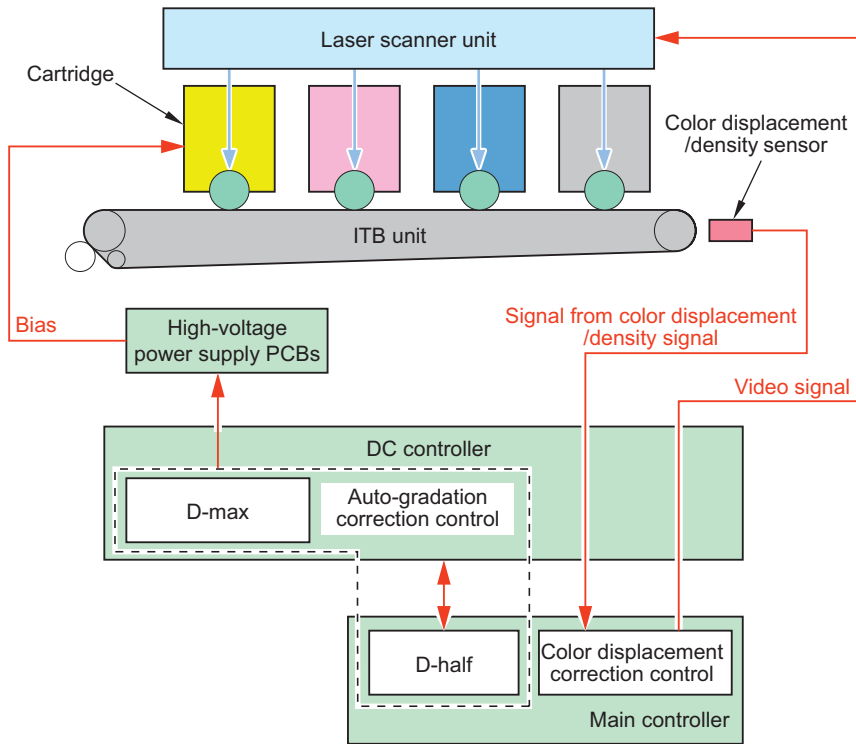

### Execution Condition/Timing

Correction controls are performed under the following conditions:

Execution timing	D-max	D-half	Color displacement correction
At power-on	Yes	Yes	Yes
When the Toner Cartridge is replaced	Yes	Yes	Yes
When the environment (temperature) changes	Yes	Yes	Yes
After printing the specified number of pages	Yes	Yes	Yes
After the specific period of time has passed	Yes	Yes	Yes
When recovering from sleep mode (8 hours or more)	Yes	Yes	-
When [Quick Adjust] is executed	Yes	Yes	-
When [Correct Print Color Mismatch] is executed	-	-	Yes

### Description

#### Image Density Correction Control (D-max control)

It is performed to stabilize the image density of the printer.  
The DC Controller corrects the primary charging bias and developing bias values.

#### Image Gradation Correction Control (D-half control)

It is performed to stabilize the image gradation of the printer.  
The Main Controller performs gradation adjustment based on the measurement results of the halftone density performed by the DC Controller.

#### Color Displacement Correction Control

Color displacement that occurs due to the individual differences of the Laser Scanner Unit and Toner Cartridge is corrected. The Main Controller performs the following color displacement corrections by controlling the video signal based on the color displacement information measured by the DC Controller.

- Write-start position in the horizontal scanning direction
- Horizontal scanning magnification ratio
- Write-start position in the vertical scanning direction

#### Auto Gradation Adjustment Control

It is performed to stabilize the gradation density characteristics of the image.



Item	Description	Test pattern	
		Number of output sheets	Type
Quick Adjust	Gradation adjustment is performed by D-half Control without outputting a test pattern.	-	-

### Additional Functions Mode/Menu

- Menu > Adjustment/Maintenance > Adjust Image Quality > Auto Adjust Gradation > Quick Adjust
- Menu > Adjustment/Maintenance > Adjust Image Quality > Correct Print Color Mismatch

## Cartridge

### Description

The cartridge of this machine has the function to form a visible image on the Photosensitive Drum with toner. There are 4 types: yellow, magenta, cyan, and black, and all of them have the same structure.

The cartridge of this machine consists of the Photosensitive Drum, Developing Unit, Primary Charging Roller, Memory, etc. The DC Controller rotates the Drum Motor, and drives the Primary Charging Roller. It also rotates the Developing Motor, and drives the Developing Roller.

The DC Controller detects the toner level by monitoring the toner level detection signal.

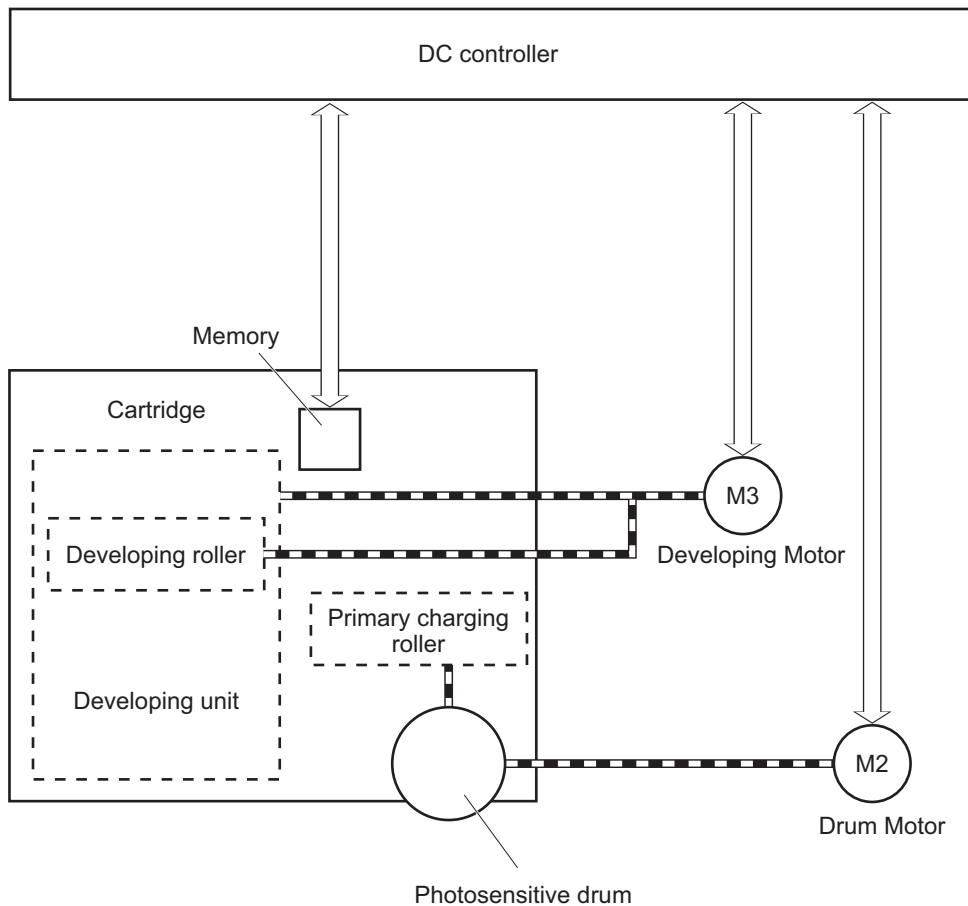

## Memory

### Description

This machine detects/records the cartridge usage status, etc. by reading/writing data stored in the memory by the DC Controller. If the memory cannot be detected, "Cartridge Communication Error. A counterfeit or non-Canon cartridge may be in use." is displayed.

## ■ Cartridge Detection

### Execution Condition/Timing

- At power-on
- When the Front Cover is closed

### Description

The DC Controller detects whether a cartridge is installed according to the change in primary charging current. The DC Controller notifies the Main Controller of the absence of a cartridge if it judges there is no cartridge.

Display on the Control Panel:  
Toner Cartridge Not Inserted

## ■ Cartridge Life Detection

### Description

The DC Controller notifies the Main Controller when cartridge consumption reaches the specified value. Upon reception of the notification the Main Controller displays a warning or a message that the cartridge has reached the end of its life.

	Warning display*2	End of life display*4, *5
Toner level*1	Differs depending on the setting*3	0%
Detected to (location)	Memory	Memory
Message (machine operation)	Prepare cartridge.	End of Cartridge Lifetime

\*1: Select the following to check the remaining toner level.

- Status Monitor > Device Information > Cartridge Information

\*2: Whether to display or hide warnings can be specified in the menu.

\*3: The threshold value to display a warning can be specified in the menu.

\*4: The operation when the cartridge has reached the end of life can be specified in service mode.

\*5: The reference value of cartridge life (Photosensitive Drum, Developing Unit, and Waste Toner) can be specified in service mode.

### Service Mode

- Setting of the behavior when the cartridge reaches the end of its estimated life  
COPIER > OPTION > FNC-SW > CRG-PROC
- Setting of the reference values for replacement of the Photosensitive Drum, Developing Assembly, and Waste Toner (Bk)  
COPIER > OPTION > FNC-SW > CRGLF-K
- Setting of the reference values for replacement of the Photosensitive Drum, Developing Assembly, and Waste Toner (Y/M/C)  
COPIER > OPTION > FNC-SW > CRGLF-CL
- ON/OFF of display of the screen for setting the threshold value for preparation of the cartridge  
COPIER > OPTION > DSPLY-SW > CRGLW-LV

### Additional Functions Mode/Menu

- Setting of whether to display or hide warnings  
Menu > Preferences > Display Settings > Display Timing for Cartridge Prep. Notif.
- Setting of the threshold value to display a warning  
Menu > Preferences > Display Settings > Display Timing for Cartridge Prep. Notif. > Custom

## ■ Developing Cylinder Engagement/Disengagement Control

### Overview

The DC Controller engages/disengages the Developing Cylinder in the Toner Cartridge with/from the Photosensitive Drum.

### Execution Condition/Timing

The Developing Cylinder is engaged or disengaged depending on the state of this machine.

State of this machine	Y/M/C	Bk
Power Supply Off/Standby	Disengagement	
B&W Print	Disengagement	Engagement
Full Color Print	Engagement	

### Description

In accordance with the specified print mode (full color or B&W), only the Developing Cylinder(s) necessary for the mode is engaged with the Photosensitive Drum.

The Developing Cylinders are engaged only when needed, and this prevents deterioration of the Photosensitive Drum and ensures the maximum life.

For engagement/disengagement of the Developing Cylinders, the DC Controller drives the Developing Disengagement Solenoid (Bk) (SL2)/Developing Disengagement Solenoid (Color) (SL3) while the Developing Motor (M3) is driving to change the orientation of the Engagement/Disengagement Cam.

The DC Controller detects the current state using the Developing Disengagement Switch (Bk) (SW3)/Developing Disengagement Switch (Color) (SW2), and determines the state (engaged or disengaged) of the Developing Cylinders on the basis of the amount of rotation of the Developing Motor after the Developing Disengagement Solenoid starts to be driven.

### Error Code

- E015-0000: Error in Developing Disengagement Motor

# Pickup Feed System

## Overview

### Overview

The pickup, feed, and delivery systems are controlled by the DC Controller.

The DC Controller controls the blocks in the pickup, feed, and delivery systems to pickup, feed, and deliver paper inside the machine.

### Description

The pickup, feed, and delivery systems consist of the following three blocks.

- Pickup/Feed: From each pickup slot to the inlet of the Fixing Assembly
- Fixing/Delivery: From the Fixing Assembly to the delivery outlet
- Duplex\*: From the Duplex Reverse Assembly to the Duplex Re-pickup Assembly

\*: Duplex models only

- ▶ Simplex paper path
- ⋯▶ Duplex paper path

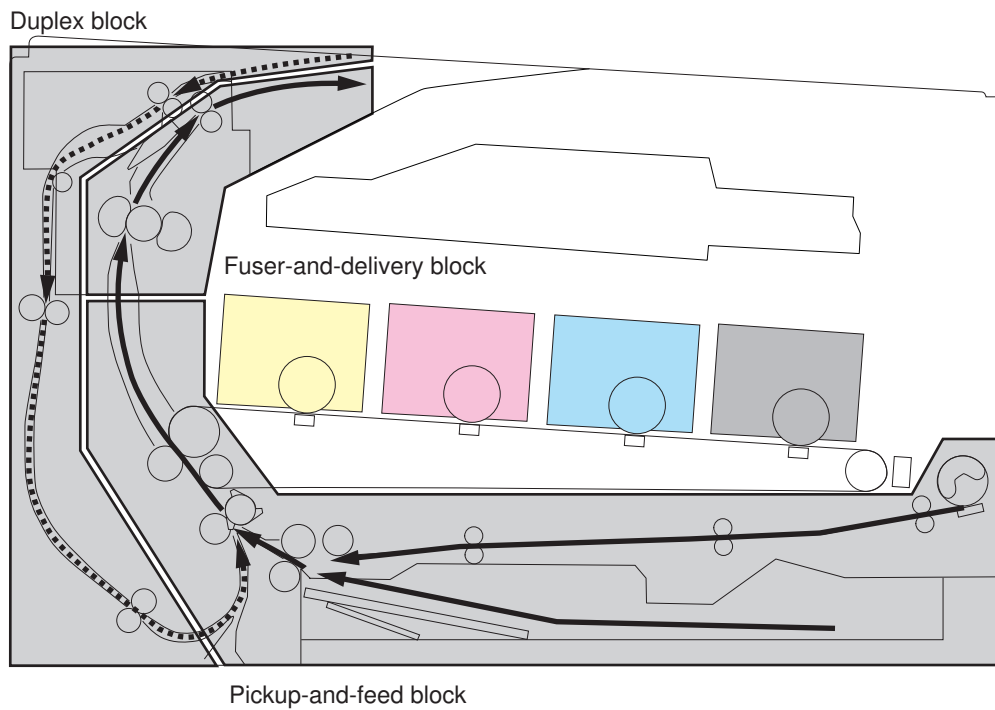

# Parts Configuration

## Description

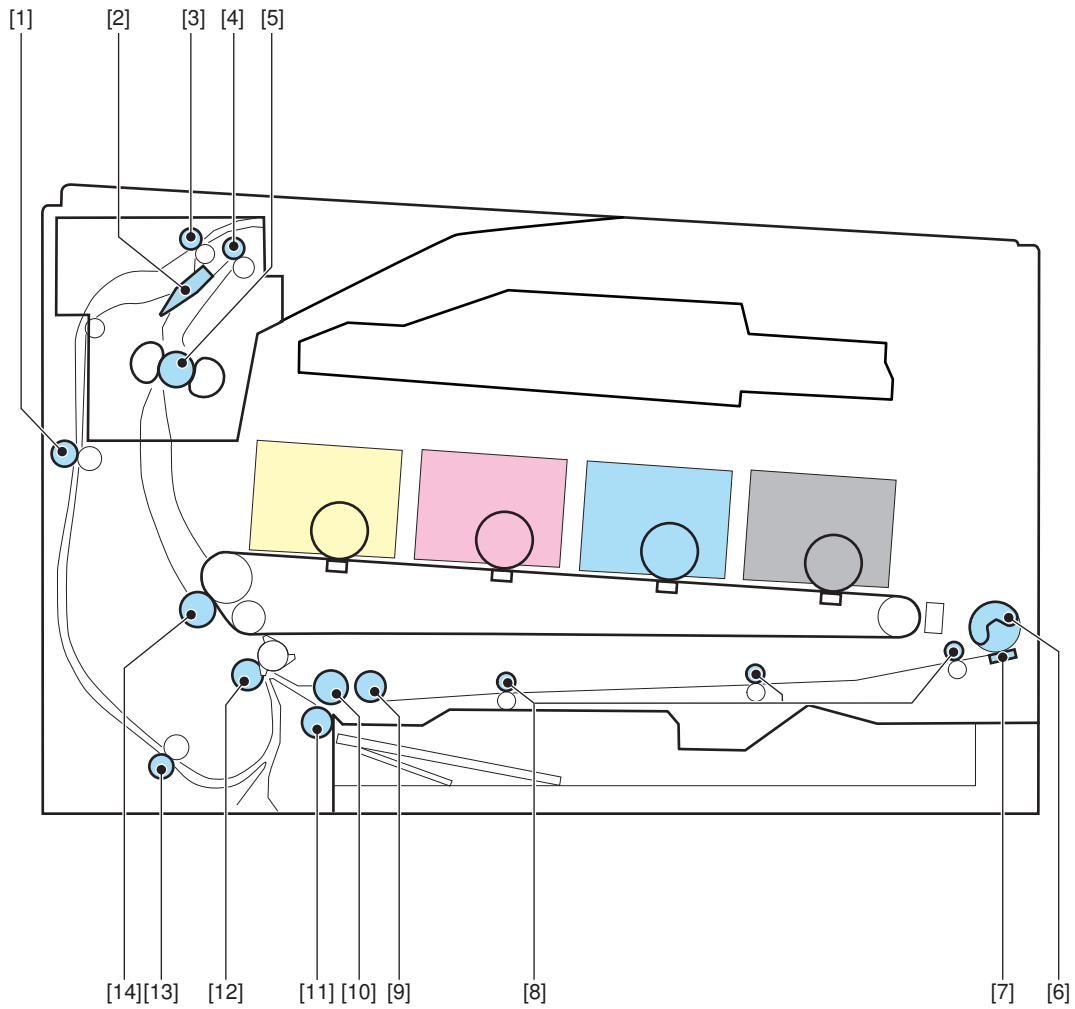

No.	Name	No.	Name
[1]	Duplex Feed Roller	[8]	Multi-purpose Tray Feed Roller
[2]	Duplex Flapper	[9]	Pickup Roller
[3]	Duplex Reverse Roller	[10]	Feed Roller
[4]	Delivery Roller	[11]	Separation Roller
[5]	Fixing Roller	[12]	Registration Roller
[6]	Multi-purpose Tray Pickup Roller	[13]	Duplex Re-pickup Roller
[7]	Multi-purpose Tray Separation Pad	[14]	Secondary Transfer Roller

## Drive Configuration

### Description

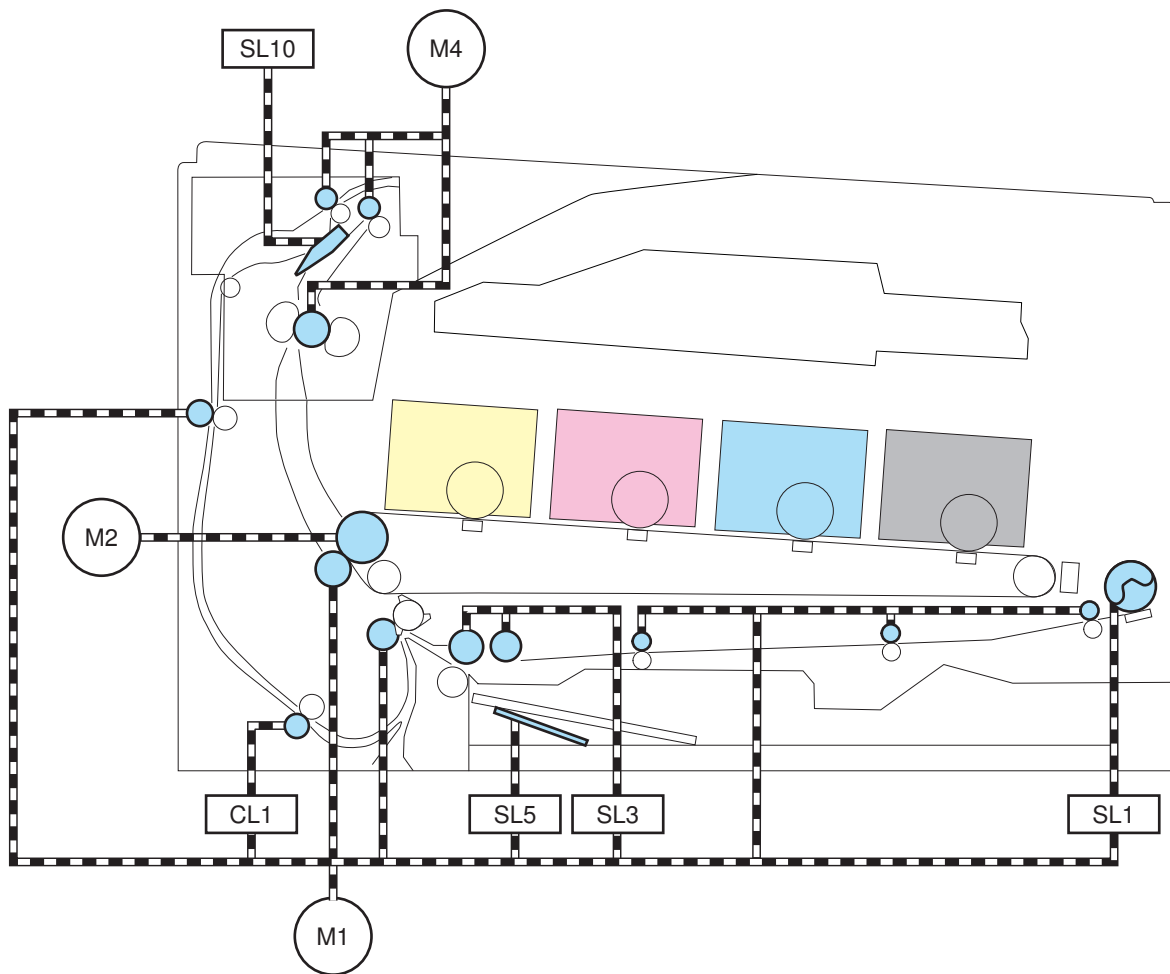

Sym- bol	Name	Sym- bol	Name
M1	Pickup Motor	SL1	Multi-purpose Tray Pickup Solenoid
M2	Drum Motor	SL3	Cassette Pickup Solenoid
M4	Fixing Motor	SL5	Lifter Solenoid
CL1	Duplex Re-pickup Clutch*	SL10	Duplex Reverse Solenoid*

\*: Duplex models only

## Layout of Sensors

### Description

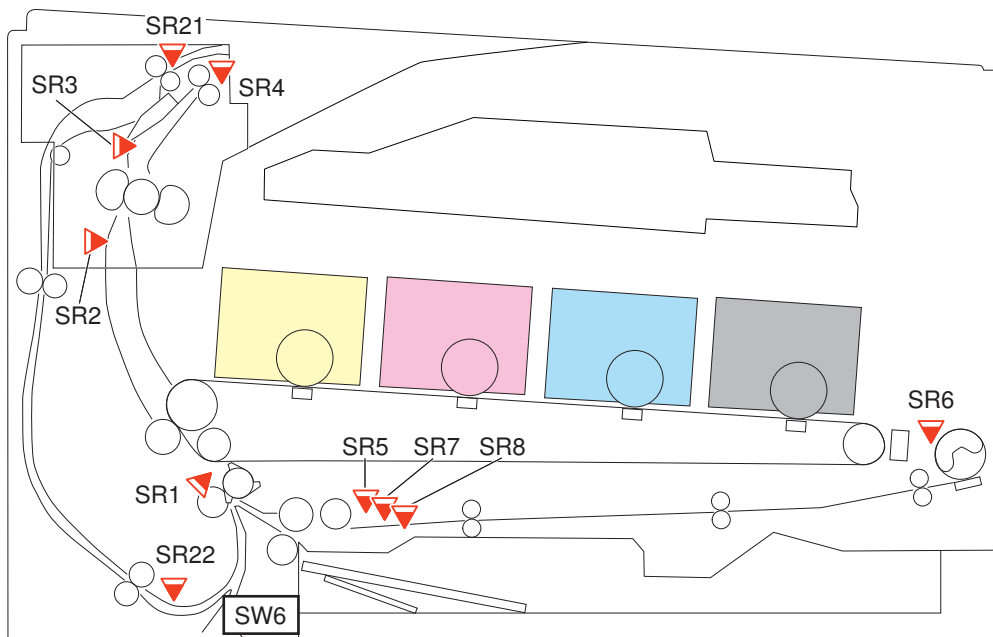

Sym- bol	Name	Symbol	Name
SW6	Cassette Switch	SR6	Multi-purpose Tray Paper Sensor
SR1	Registration Sensor	SR7	Cassette Paper Surface Sensor
SR2	Loop Sensor	SR8	Lifter Sensor
SR3	Fixing Delivery Sensor	SR21	Duplex Reverse Sensor*
SR4	Delivery Tray Sensor	SR22	Duplex Re-pickup Sensor*
SR5	Cassette Paper Sensor		

\*: Duplex models only

## Lifter Control

### Description

Paper inside a cassette is lifted up by the Lifting Plate.

The Lifting Plate is lifted by driving the Pickup Motor (M1) and Lifter Solenoid (SL5).

When the paper surface reaches the position of the Pickup Roller, the Cassette Paper Surface Sensor (SR7) is turned ON to detect that the paper has reached the pickup position.

When the Lifting Plate is rising, the Pickup Motor (M1) and Lifter Solenoid (SL5) are controlled to keep the paper surface steady so that pickup can be performed stably.

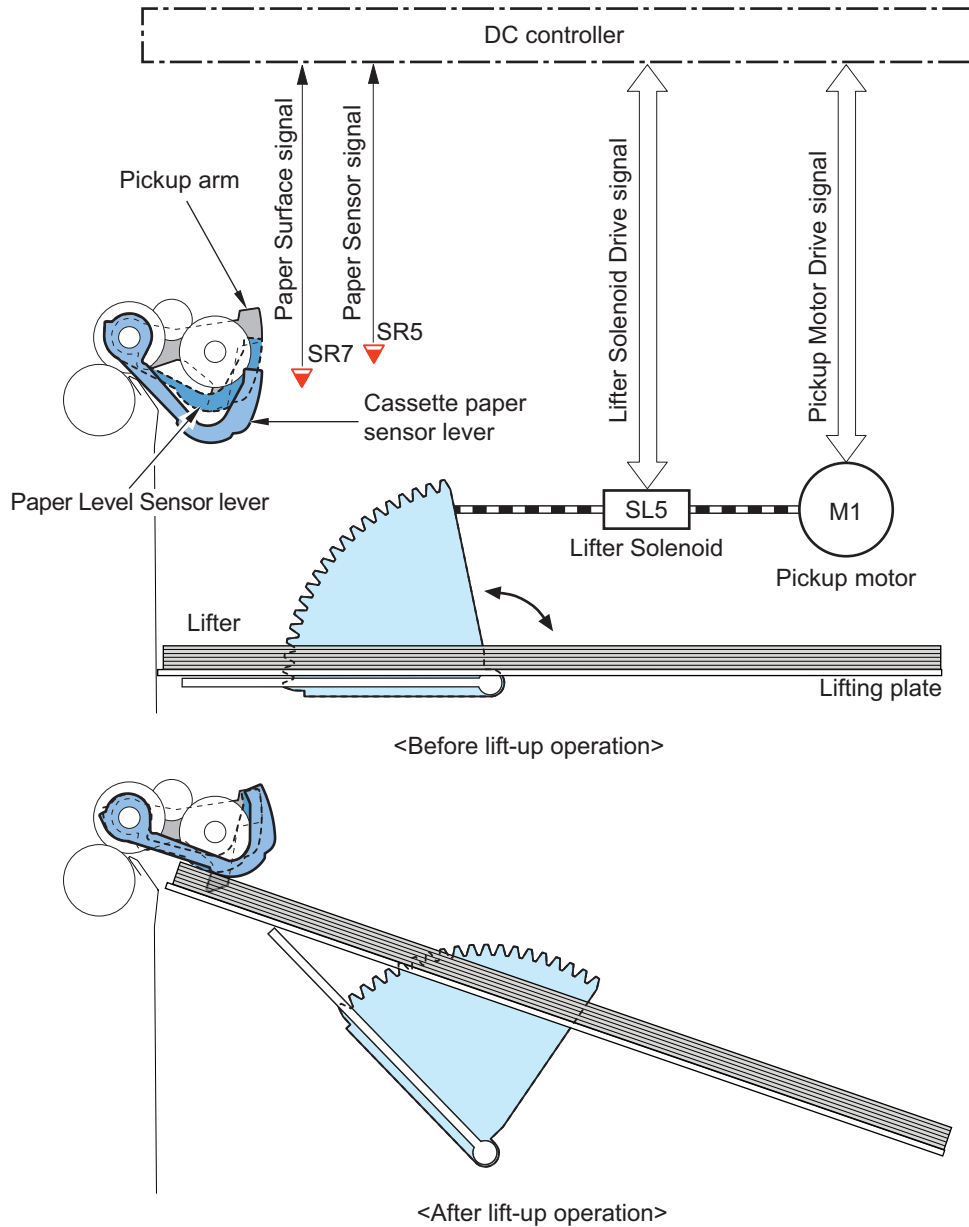

There are 2 types of lift-up operation: initial lift-up operation and lift-up operation during printing.

1. Initial lift-up operation

When the power is turned ON or a cassette is inserted, the Pickup Motor (M1) and Lifter Solenoid (SL5) are driven to lift up the Lifting Plate to the position for detection if the Cassette Paper Surface Sensor (SR7) does not detect the paper surface.

2. Lift-up operation during printing

This operation is performed if the paper surface is lowered a certain amount by the pickup operation.

If the Cassette Paper Surface Sensor (SR7) detects that there is no paper during printing, the Pickup Motor (M1) and Lifter Solenoid (SL5) are driven to lift up the Lifting Plate to the pickup position.

### Error Code

- E015-0001: Cassette 1 lift-up error
- E015-0002: Cassette 2 lift-up error

## Cassette Detection

### Description

Presence of the cassette is detected using the Cassette Switch (SW6).

The cassette detection flag of the cassette is detected by the Cassette Detection Switch in the host machine.



## Cassette Pickup Control

### Description

The DC Controller rotates the Pickup Roller by rotating the Pickup Motor (M1).

The Pickup Arm is lifted and lowered to feed the paper by rotating the Pickup Cam with the Pickup Solenoid (SL3).

### Double Feed Prevention Mechanism

This machine employs the Separation Roller method for double feed prevention.

The Separation Roller method of this machine is a method that prevents paper double feeds by using the Separation Roller without drive.

The Separation Roller is driven and rotated by the Pickup Roller.

- At normal time  
The Separation Roller is driven by the Pickup Roller drive via paper. This causes the Separation Roller to rotate in the feed direction.
- During Double Feed  
Since the friction force between sheets of paper becomes weaker when there are multiple sheets of paper, the Pickup Roller drive force transmitted to the Separation Roller becomes extremely weak. Since force suppressing rotation is applied to the Separation Roller of this machine, this mechanism does not allow rotation by the weak drive force transmitted from the Pickup Roller during double feed. The Separation Rollers therefore do not rotate and do not pickup double feed paper.

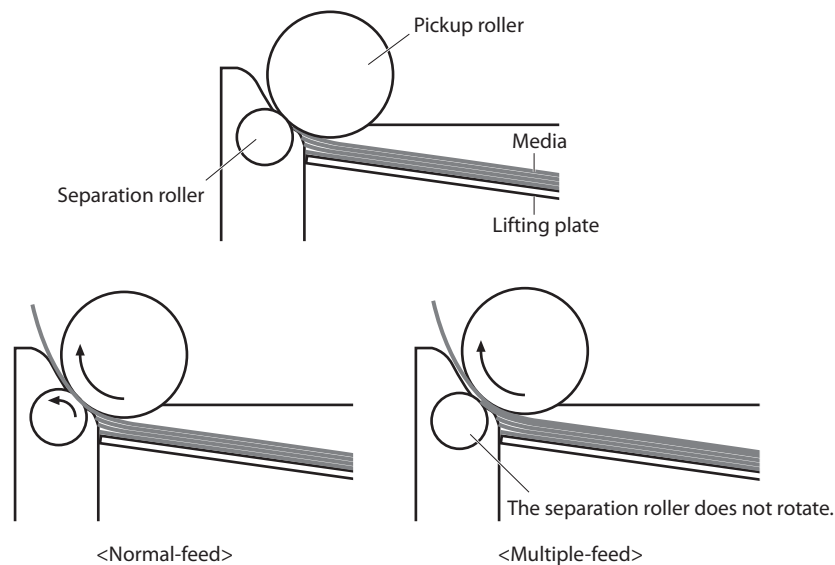

## Multi-purpose Tray Pickup Control

### Description

The Multi-purpose Tray pickup feeds paper from the Multi-purpose Tray one sheet at a time into the machine.

The following describes the operation of the Multi-purpose Tray pickup.

1. When a print command is input from the Main Controller, the DC Controller rotates the Pickup Motor (M1).
2. When the DC Controller turns ON the Multi-purpose Tray Pickup Solenoid (SL1), the Multi-purpose Tray Pickup Roller rotates and paper is picked up.
3. After double feed paper is removed by the Multi-purpose Tray Separation Pad, paper is fed into the machine. Note that the presence of paper on the Multi-purpose Tray is detected by the Multi-purpose Tray Paper Sensor (PS6), and printing is not performed if there is no paper.

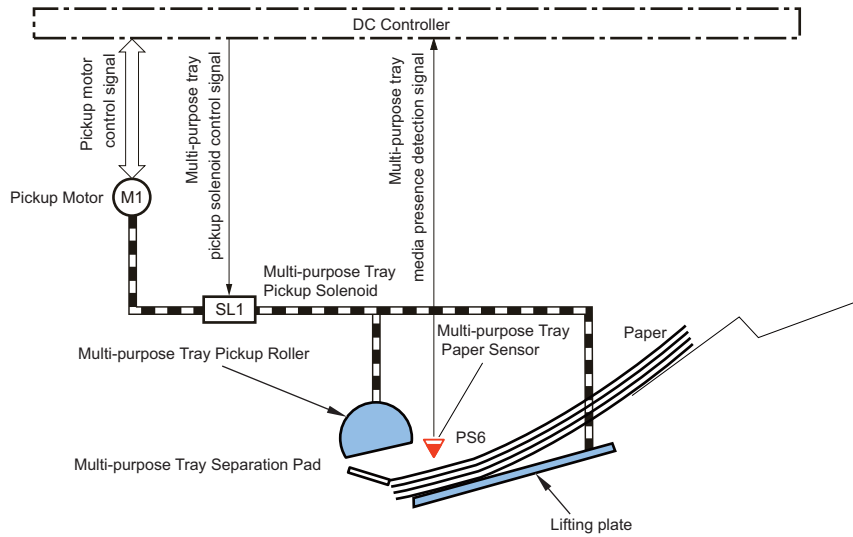

## Skew Correction

### Description

This machine can correct paper skew without lowering throughput.

Skew is corrected as follows.

1. The paper leading edge pushes against the Registration Shutter to align the leading edge of the paper.
2. The trailing edge of the paper is fed and slack is generated at the leading edge of the paper.
3. When the trailing edge is fed even further, the paper leading edge for which slack was generated pushes up the Registration Shutter and then the paper is fed to the Registration Roller while the paper leading edge is aligned.

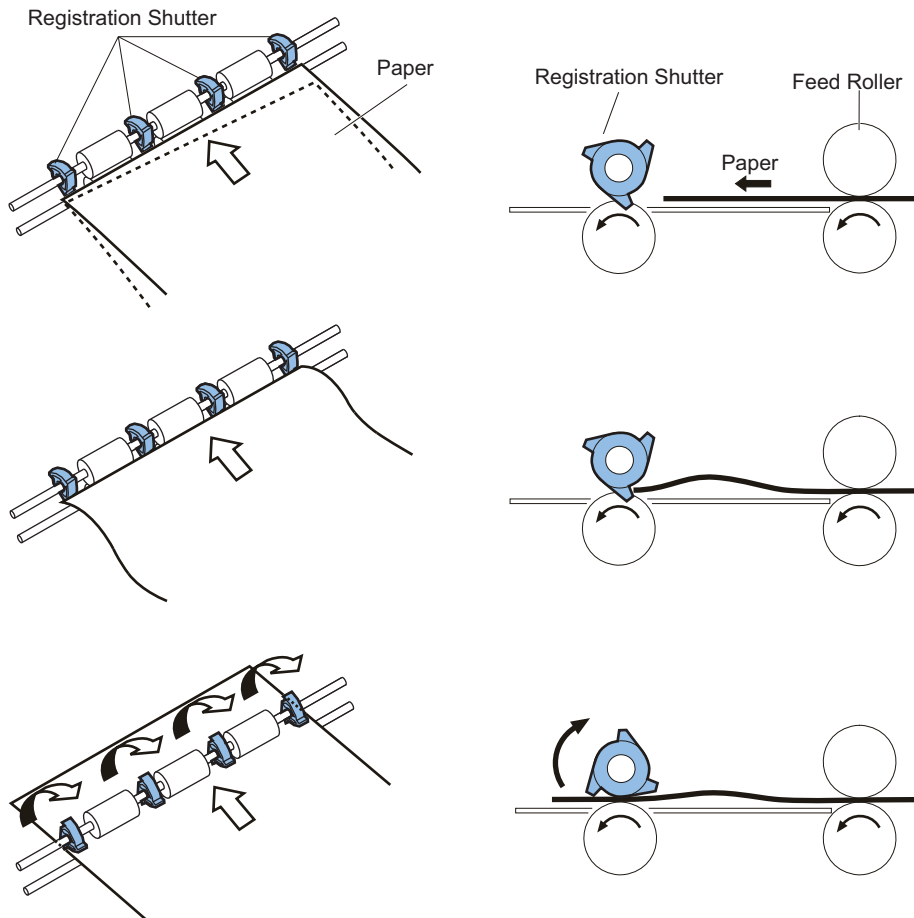



## Description

Arch control keeps the appropriate slack on paper to prevent image failure and feed failure.

- If the rotation speed of the Fixing Motor is slower than the rotation speed of the Drum Motor, the slack on the paper becomes larger.
- If the rotation speed of the Fixing Motor is faster than the rotation speed of the Drum Motor, the slack on the paper becomes smaller.

The DC Controller detects the slack on paper by the Loop Sensor (SR2), and controls the rotation speed of the Fixing Motor.

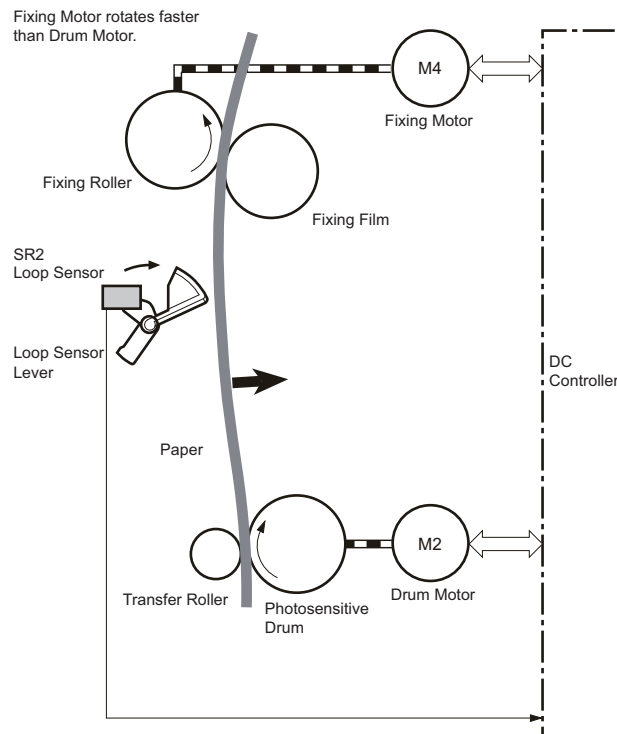
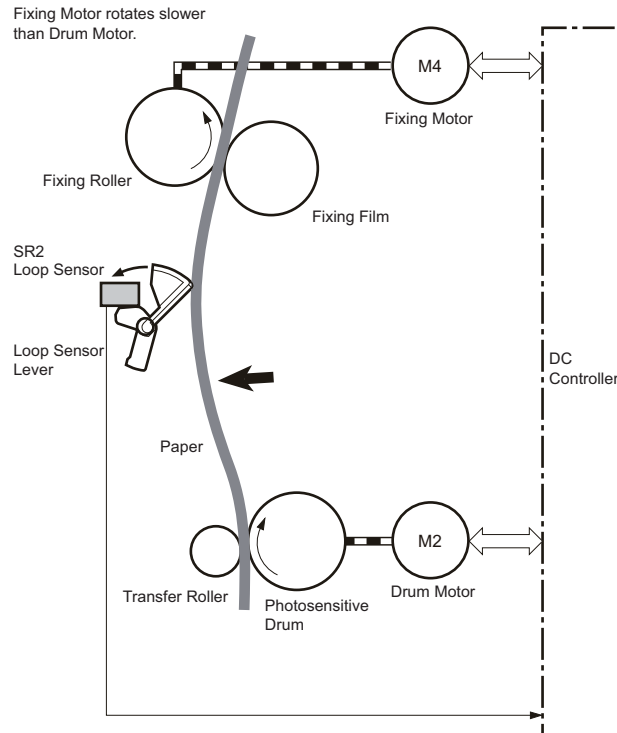

## Delivery Tray Full Detection

### Description

The DC Controller detects paper full in the Delivery Tray using the Delivery Tray Sensor (SR4). The DC Controller judges that the Delivery Tray is full and notifies the Main Controller when the Delivery Tray Sensor detects paper for a specified period of time during printing.

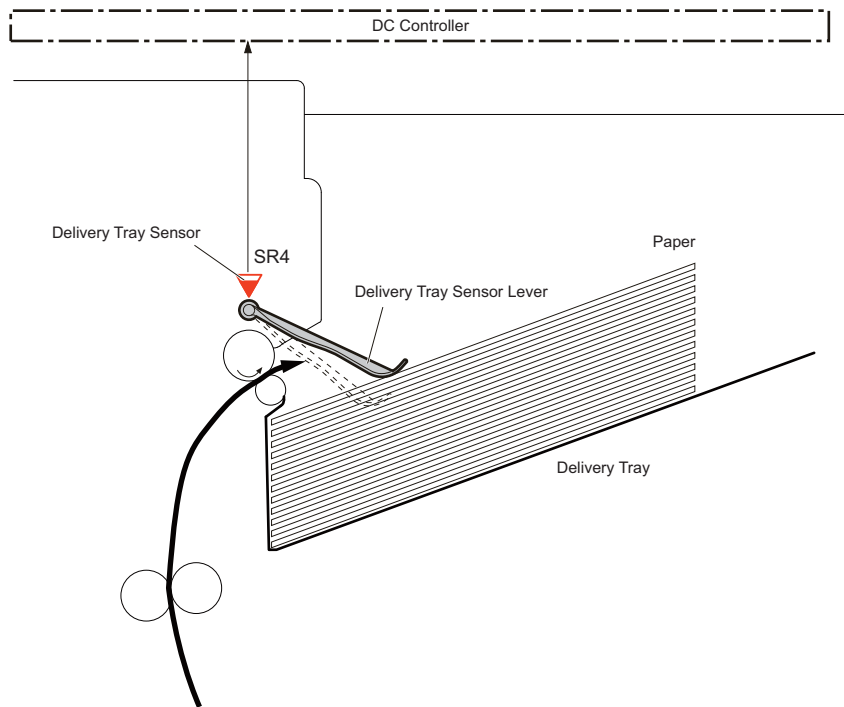

## Jam Detection

### Description

The sensors are provided at the locations shown below to detect the presence of print paper and whether the print paper is being fed correctly.

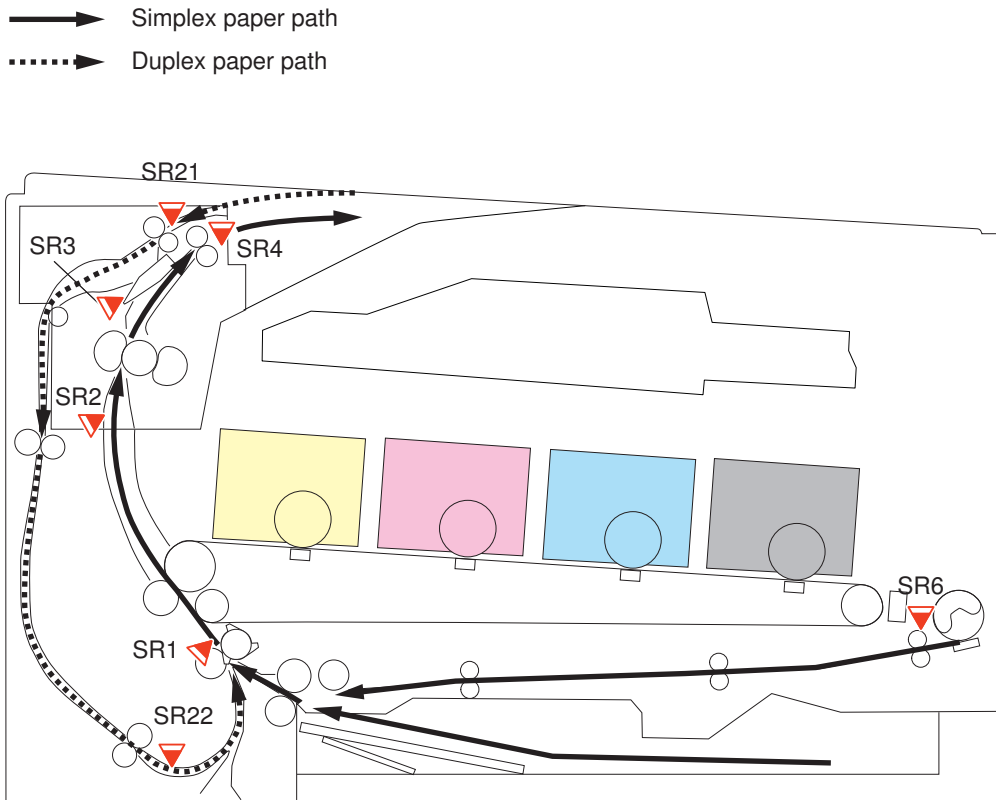

Occurrence of a jam is judged by whether paper is in the sensor area at the timings stored in the DC Controller. When the DC Controller judges that a jam has occurred, the printing operation is stopped and the jam is notified to the Main Controller at the same time. The following shows the jams that are detected.

Jam name	Details
Pickup delay jam 1	When the Registration Sensor (SR5) fails to detect the leading edge of paper after the start of image formation and before the start of re-pickup
Pickup delay jam 2	When the Multi-purpose Tray Paper Sensor (SR6) fails to detect the leading edge of paper within a specified period of time after the start of pickup from the Multi-purpose Tray
Pickup Stationary Jam	When the Registration Sensor (SR5) fails to detect the trailing edge of paper within a specified period of time after the start of re-pickup
Fixing delivery delay jam	When the Fixing Delivery Sensor (SR3) fails to detect the leading edge of paper within a specified period of time after the start of re-pickup
Fixing delivery stationary jam	When the Fixing Delivery Sensor (SR3) fails to detect the trailing edge of paper within a specified period of time after the Registration Sensor (SR5) detects the trailing edge of paper
Internal stationary jam	When one of the following sensors detects presence of paper at power-on, door close, or before/after print operation <ul style="list-style-type: none"> <li>• Registration Sensor (SR5)</li> <li>• Fixing Delivery Sensor (SR3)</li> <li>• Delivery Sensor (SR4)</li> </ul>
Door Open Jam	When one of the sensors detects presence of paper when door open is detected during printing
Wrapping jam	When the Fixing Delivery Sensor (SR3) turns OFF after the Fixing Delivery Sensor (SR3) detects the trailing edge of paper and before detection of a fixing delivery stationary jam is started
Duplex Re-pickup Assembly Jam	At 2-sided print, the paper was reversed, but the Duplex Re-pickup Sensor (SR22) failed to detect the leading edge of paper within a specified period of time.
Delivery Delay Jam	When the Delivery Sensor (SR4) fails to detect the leading edge of paper within a specified period of time after the Fixing Delivery Sensor (SR3) detects the trailing edge of paper
Delivery Stationary Jam	When the Delivery Sensor (SR4) fails to detect the trailing edge of paper within a specified period of time after the Delivery Sensor (SR4) detects the leading edge of paper

## Fixing System

### Functional Configuration

#### Overview

The fixing system forms a permanent image by melting the toner on the paper using pressure and heat.

#### Description

The fixing control circuit controls the temperature of the Fixing Assembly.

The Fixing Assembly of this machine uses the on-demand fixing method.

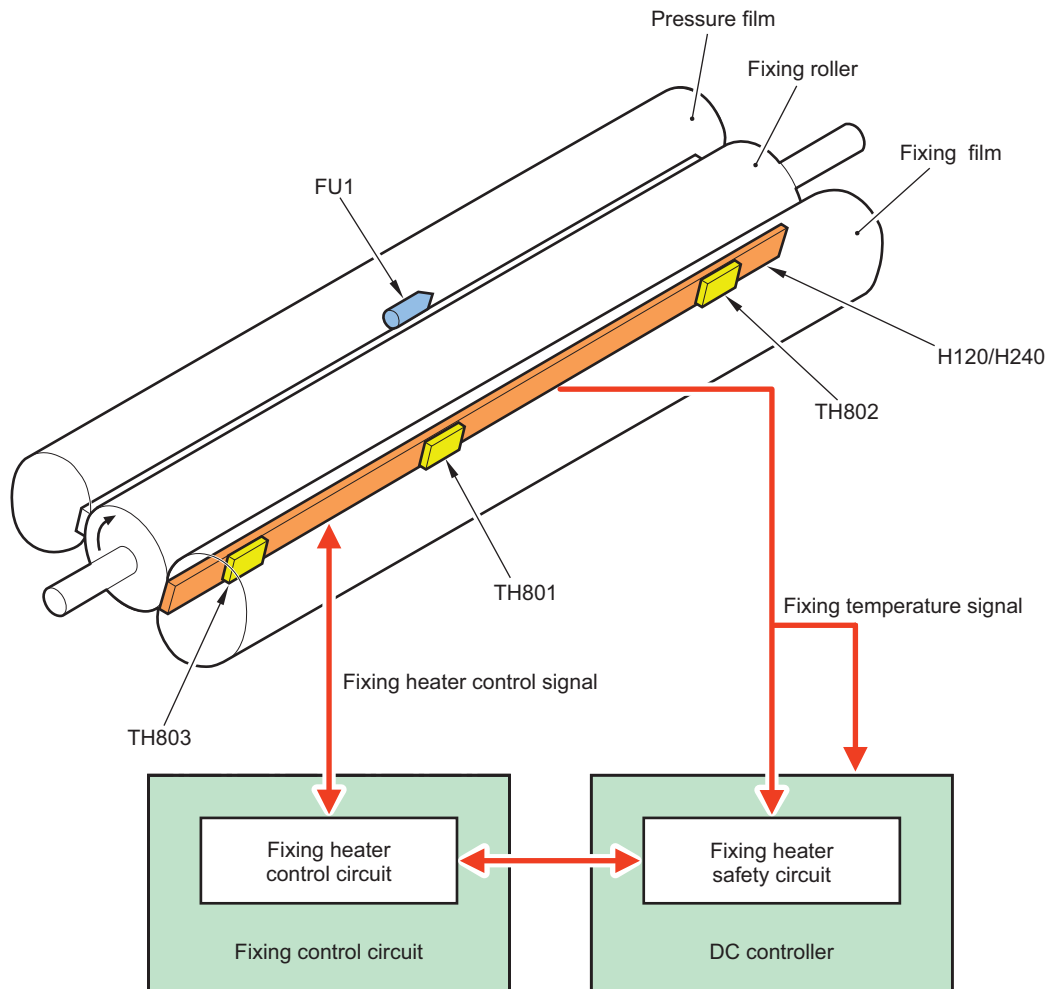

Symbol	Parts name
H120	Fixing Heater (120 V)
H240	Fixing Heater (240 V)
TH801	Main Thermistor
TH802	Sub Thermistor 1
TH803	Sub Thermistor 2
FU1	Temperature Fuse

Temperature control of the Fixing Assembly which consists of these parts is performed by the Fixing Heater control circuit and Fixing Heater safety circuit according to the command of the DC Controller.

### Fixing Temperature Control

#### Overview

This control circuit controls the temperature such that the Fixing Heater reaches the target temperature.

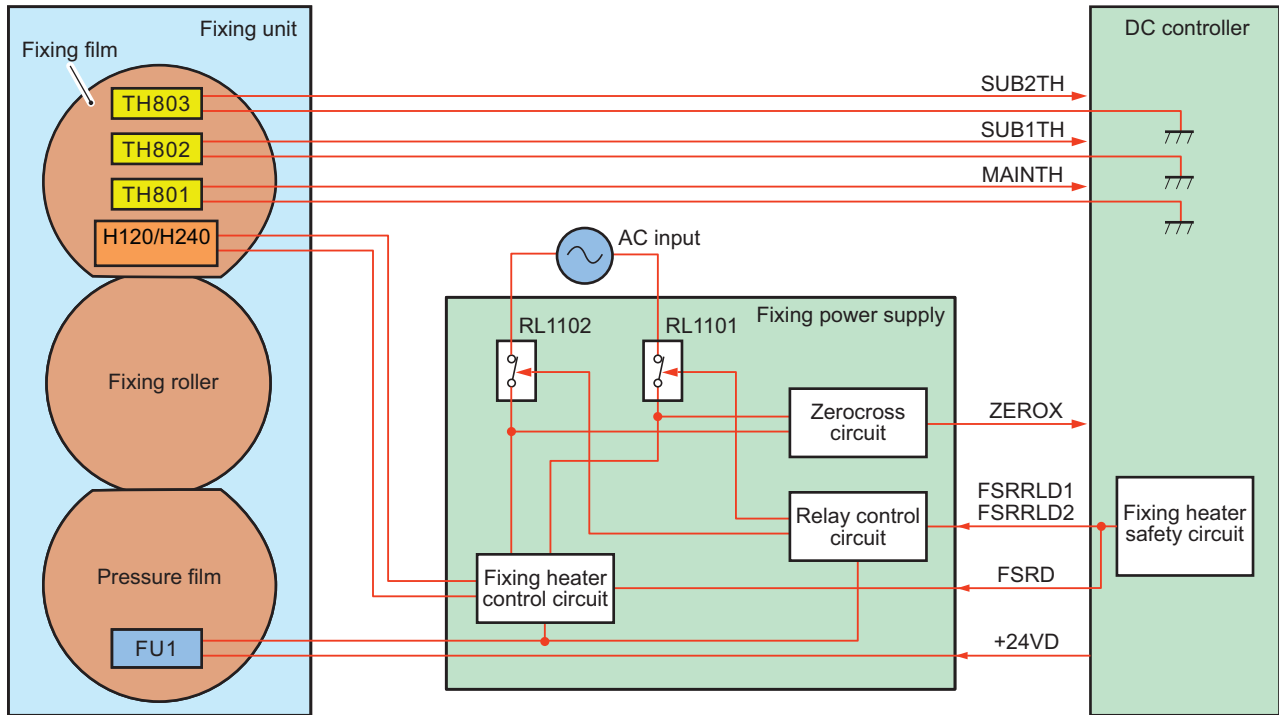

### Description

The DC Controller monitors the fixing temperature detection signal and outputs a fixing control signal according to the detected temperature. The fixing control circuit controls the Fixing Heater on the basis of this signal, and controls the temperature of the Fixing Heater to the target value.

## Protection Function

### Overview

This machine has a function to detect abnormal temperature rising in the Fixing Assembly and cut off the power supply to the Fixing Heater.

### Description

This machine has the following three protection functions to prevent abnormal temperature rising in the Fixing Heater.

- DC Controller
- Fixing Heater safety circuit
- Temperature Fuse

The following describes the details.

#### DC Controller

The DC Controller monitors the thermistor temperature of the Fixing Heater (Center). When it exceeds the specified temperature, it is judged that the temperature of the Fixing Assembly is abnormally high, and the fixing control signal (FSRD) output is stopped, the relay is turned OFF, and the power supply to the heater is turned OFF.

#### Fixing Heater safety circuit

The Fixing Heater safety circuit monitors the thermistor temperature of the Fixing Heater (Center). When it exceeds the specified temperature, it is judged that the temperature of the Fixing Assembly is abnormally high, and the relay is turned OFF and the power supply to the heater is turned OFF.

#### Temperature Fuse

If the temperature of the Fixing Heater rises abnormally and the temperature of the Fixing Fuse exceeds the specified temperature, the Temperature Fuse opens and the power supply to the heater turns OFF.

## Fixing Assembly Failure Detection

### Overview

When the machine is under the following conditions, the DC Controller shuts down the power supply to the Fixing Assembly and notifies an error.

- Startup failure
- Abnormal high temperature failure
- Abnormal low temperature failure

### **Description**

#### **Fixing Assembly startup failure**

An error code is notified if the Fixing Assembly does not reach a certain temperature within a specified period of time.

#### **Abnormal high temperature failure**

An error code is notified if an abnormally high temperature is detected in the Fixing Assembly.

#### **Abnormal low temperature failure**

An error code is notified if an abnormally low temperature is detected in the Fixing Assembly.

### **Error Code**

E000: Startup failure

- E000-0000: Fixing Assembly startup failure

E001: Abnormal high temperature failure

- E001-0001: Abnormal high temperature of Fixing Assembly

E003: Abnormal low temperature failure

- E003-0001: Abnormal low temperature of Fixing Assembly





# Technical Explanation (System)

Overview of System Management.....	42
Version Upgrade.....	43
Setting Information Export/Import Function (DCM).....	47
Monitoring Function (e-Maintenance/ imageWARE Remote).....	60

## Overview of System Management

This chapter describes information for service technicians on the system of this machine. Although this chapter contains some information described in the User's Guide, for details on the functions for users, refer to the e-Manual.

# Version Upgrade

## Function Overview

The following firmware upgrade methods are available with this device.

### Version upgrade using User Support Tool (UST).

Upgrade the firmware of the device using UST

Open the file for UST version upgrade on a PC connected with the device and upgrade the firmware.

Since the host machine and the PC are connected using a USB cable, version upgrades can be performed in an environment where a network is not available.

### Version upgrade via Internet

Access the dedicated server, and download and upgrade the firmware.

Provided that Internet connection is available, the system automatically configures the connection destination setting and executes processing such as download and version upgrade.

### Version upgrade using a USB flash drive

Upgrade the firmware of this machine using a USB flash drive.

Connect a USB flash drive where the firmware is stored to the device, and update the firmware in service mode.

Version upgrades can be performed in an environment where a PC or network is not available.

### Version upgrade by replacing the PCB

Version upgrade by replacing the existing PCB with a PCB where the latest firmware is installed

### Version upgrade using Local CDS

Use iW EMC/iW MC and DFU plug-in to download firmware from Local CDS and upgrade the host machine.

#### NOTE:

When using Local CDS to upgrade it, refer to the manual/material of iW EMC/iW MC DFU plug-in.

#### CAUTION:

A message appears when an attempt is made to upgrade a host machine to which specified firmware has been applied.

This is a precaution not to use wrong firmware to upgrade a host machine to which specified firmware has been applied.

See the following regarding the combination of whether the message will be displayed:

Type of firmware applied to the host machine	Firmware to upgrade	
	General firmware	Specified firmware
General firmware	No message	No message
Specified firmware	Message displayed	Message displayed

## Version Upgrade Using UST

UST is included in the firmware for the machine that can be downloaded from the website of CINC. Firmware is downloaded as a zip file and a folder containing UST is extracted by decompressing the file.

When executing UST on the PC connected to the machine with a USB Cable, the firmware can be upgraded by downloading it from the PC to the machine. For the detailed procedure, refer to "User Support Tool Operation Guide" stored in the decompressed folder. "User Support Tool Operation Guide" is also available on the website of CINC.

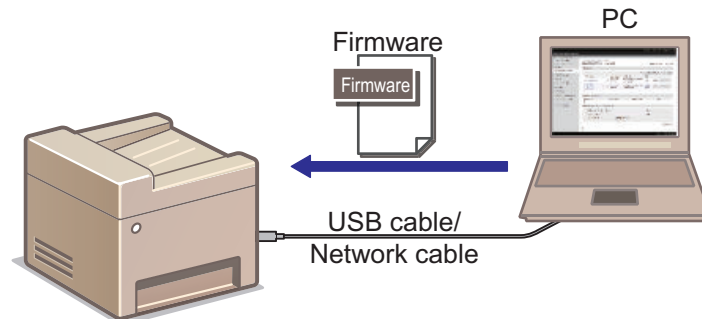

## Version Upgrade via Internet

Connect to the Internet using the network function of the device, and download and upgrade the latest firmware from the server. If the device is in an environment where Internet connection is available, firmware versions can be upgraded only by operation from the menu without using PC.

### Prerequisite

In order to perform version upgrade of the device via Internet, the following conditions must be met.

#### There should be no other jobs being executed.

Firmware cannot be upgraded while there is a job being executed. If there is a job being executed, wait for completion of the job and then perform the work.

#### The device should be able to be connected to the external network.

If connection is not available because, for example, there is a proxy server, follow the e-Manual to configure the proxy server settings and enable connection to the external network.

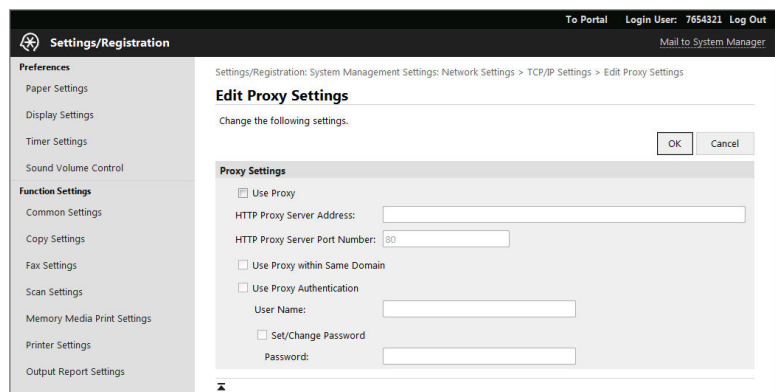

#### The serial number of the host machine should be shown on the Main Controller PCB.

Whether or not the serial number of the host machine is shown on the Main Controller PCB can be checked from the Control Panel or SPEC REPORT.

#### Procedure to check from SPEC REPORT

1. Execute the following service mode to print SPEC REPORT.
  - COPIER > FUNCTION > MISC-P> SPEC

2. Check if the serial number (3 alphabetical characters + 5-digit number) is shown in [BODY No.] of the printed SPEC REPORT.

***** *** SPEC REPORT *** *****	
Device Info	ZZ999 Series
ROM Version	
MAIN	00.75
BOOT	00.25
LANG	01.36
ECONT	00.10
PANEL	05.01
Device Code	A0000000
Locale	9
Version TVno	0
BODY No.	ZZZ99999
Factory Flag	12345678

## ■ Procedure for Upgrading the Firmware via Internet

### 1. Select the following menu to upgrade the firmware via Internet:

- [Management Settings] > [Remote UI Settings/Update Firmware] > [Update Firmware] > [Via Internet] > [Yes]
- When the upgrading of firmware is completed, the machine automatically restarts.

### 2. Select the following menu, and check that the firmware has been correctly upgraded:

- [Management Settings] > [Remote UI Settings/Update Firmware] > [Update Firmware] > [Version Information]

#### CAUTION:

This function does not support the operations from remote UI. ([Update Firmware] does not exist in the [System Management Settings] menu of the remote UI.)

## ■ Messages

The message displayed on the device operation panel is as follows.

No	Error message	The timing of occurrence	Remedy
1	Job in progress... Wait a moment, then try again.	If there is a job being executed:	1. Wait until the job is completed. 2. Cancel the job.
2	Cannot check the firmware version. (Server communication error.)	Network error	1. Check whether the device can be connected to the external network. 2. Check whether the proxy setting has been made (in case of access via a proxy server).
3	Cannot download the firmware. (Error during download.)		1. Check whether the device can be connected to the external network. 2. Check whether the proxy setting has been made (in case of access via a proxy server). 3. Check that the serial number of the host machine is shown on the Main Controller PCB.
4	***DOWNLOAD MODE*** NETWORK AVAILABLE IP ADDRESS IP address of the machine PRESS STOP KEY TO EXIT	If update (writing) of the firmware has ended in failure:	1. Update the firmware again using UST.
5	***DOWNLOAD MODE*** FAILED TO UPDATE		
6	***DOWNLOAD MODE*** UPDATE IS COMPLETE	If the update of the firmware is successful	-

## ● Version Upgrade Using USB

Connect a USB flash drive where the firmware is stored to this machine, and update the firmware in service mode.

## ■ Prerequisite

In order to perform version upgrade of the machine using a USB flash drive, the following conditions must be met.

### **There should be no other jobs being executed.**

Firmware cannot be upgraded while there is a job being executed. If there is a job being executed, wait for completion of the job and then perform the work.

## ■ Procedure for Upgrading the Firmware Using a USB Flash Drive

1. **Connect a USB flash drive where the firmware is stored to this machine.**
2. **Execute one of the following service modes.**
  - COPIER > FUNCTION > SYSTEM > DOWNLOAD
  - COPIER > FUNCTION > SYSTEM > DOWNLOAD\_FORCE

### **NOTE:**

If you want to apply only firmware that is newer than the firmware currently applied in the machine, execute DOWNLOAD. If you want to apply all the firmware contained in the USB flash drive regardless of whether it is newer or older, execute DOWNLOAD\_FORCE.

3. **The signature data of the downloaded file is verified, and download instruction information is written to the designated area of the flash memory only if the verification result is correct.**
4. **The machine is automatically restarted.**
5. **When the upgrading of firmware is completed, the machine automatically restarts.**

## Setting Information Export/Import Function (DCM)

### Overview

Various data is stored in the storage inside the device.

Depending on the works to be done such as replacing parts, this data needs to be backed up and restored.

There are some ways to back up and restore data, and the appropriate one should be used depending on the purpose and storage destination.

This section describes the procedure for backing up and restoring service mode setting values.

For the procedure for backing up and restoring other information, refer to the e-Manual.

### Function Overview

This machine has a setting information export/import function (hereinafter referred to as DCM (Device Configuration Management) function) which exports/imports the machine's setting value information as a file. The file exported/imported using the DCM function is called a DCM file, and the target setting information is as follows:

- Setting information of the menu ([Settings/Registration] menu)
- Service mode setting information
- Address Book

The DCM file is exported to a USB flash drive or PC local disk from the Control Panel or remote UI.

The exported DCM file can be returned to the original device or imported to a different device.

When the file is returned to the original device, this can be used as a function to back up the settings, and when the file is imported to a different device, this can be used as a function to copy setting information.

Data can also be imported to or exported from an iR-ADV machine by using iW EMC/MC DCM Plug-in.

In the case of the setting value backup function before implementation of the DCM function, an exported file could be imported only to the same device, but the DCM function enables import of an exported file to a different device.

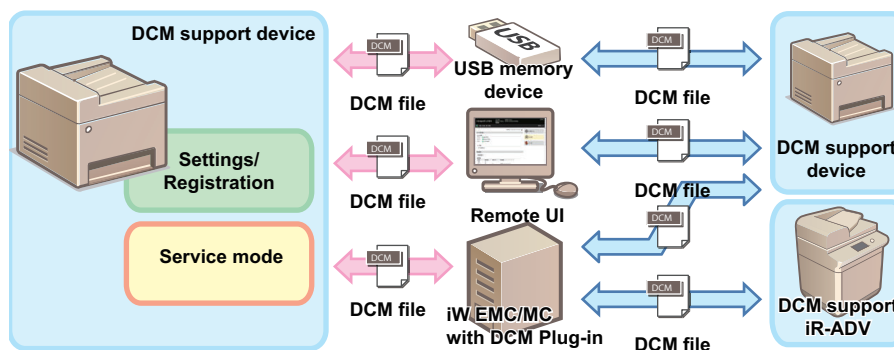

Conceptual diagram

#### NOTE:

In order to export or import setting information using DCM, it is necessary that the device supports DCM.

### Backup/Restoration for Service Technicians

#### Backup and Restoration from the Menu ([Settings/Registration] Menu)

Setting information can be backed up and restored from the Control Panel of the device or from the menu ([Settings/Registration] menu) of remote UI.

Although the menu ([Settings/Registration] menu) is for users, the service mode settings information can be backed up and restored from the Import/Export function by changing the service mode setting.

The service mode settings information can be backed up and restored only by accessing from the remote UI [Settings/Registration] menu.

#### Backup/Restoration Using Service Mode

Some of the functions in service mode can be used to backup and restore data.

Setting value information and service counter (DC-CON) values can be backed up and restored.

## ■ Combination of Information Exported/Imported by DCM, Means, and Storage Locations

A DCM file is exported and imported using the Control Panel, remote UI, or the iW EMC server, depending on the situation of the site.

The information exported/imported differs depending on the means.

Combinations of them are shown in the following table.

Menu used	Operation	Information exported			Save destination
		Setting values of menu options	Address book <sup>**1</sup>	Service mode setting values	
[Settings/Registration] menu	Control panel	Yes (fixed) <sup>*2</sup>	Yes (fixed) <sup>*2</sup>	No	USB flash drive
	Remote UI	Yes	Yes	With conditions <sup>*3</sup>	USB flash drive
Service mode	Control panel	No	No	Yes	USB flash drive / Storage in the host machine
	Remote UI	No	No	Yes	PC local disk

## ■ Compatibility of Data

The following table shows compatibility of data in the case where the device from which the data is exported and the device to which the data is imported differ in model and/or serial number.

For items that are imported in Cases A, B, and C, refer to “List of Items Which Can Be Imported” on page 53.

Model	Serial number	Import process
Same	Same	Items corresponding to Case A are imported. <sup>*4</sup>
Same	Different <sup>*5</sup>	Items corresponding to Case B are imported. <sup>*4</sup>
Different	Different <sup>*5</sup>	Items corresponding to Case C are imported. <sup>*6</sup>
Different	Same	The file is judged to be invalid, and the process ends with an error.

## ■ Replacement Mode

When this function is used for migrating the setting data upon replacement of a device, some of the data cannot be migrated depending on the model to which the data is migrated.

When this function is used in normal mode, data that is applicable to either Case B (of different serial number) or Case C (of different mode) cannot be imported.

When replacement mode of the device to which the data is imported is enabled, data can be forcibly migrated even to a device of a different serial number or even between different models.

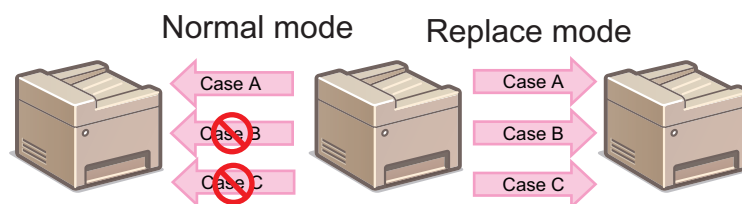

<sup>\*1</sup>. Models without address books are excluded. In the case of a fax option model without SEND function, address books are exported only if a fax option is connected with the device.

<sup>\*2</sup>. When the [Settings/Registration] menu is used from the Control Panel, both the setting menu information and the address book are imported/exported. It is not possible to export/import only either of them. Information which is not included in the data to be imported is not imported.

<sup>\*3</sup>. Service mode is added to the data to be exported only when service mode COPIER > OPTION > USER > SMD-EXPT is set. For information on items that are imported, refer to “List of Items Which Can Be Imported” on page 53.

<sup>\*4</sup>. If the firmware version at the time of import differs from that at the time of export, predetermined corrective processing may be performed.

<sup>\*5</sup>. If a serial number is missing, the serial numbers are judged to be mismatched.

<sup>\*6</sup>. Predetermined corrective processing may be performed.



The following shows the procedure to turn ON replacement mode of the device to which the data is imported:

**1. Set the following service mode setting value to "1":**

- COPIER > OPTION > USER > RPL-IMP

**NOTE:**

Refer to "List of Items Which Can Be Imported" on page 53 for the target data of replacement mode.

**CAUTION:**

Since replacement mode is not lifted automatically, the setting value of the foregoing service mode needs to be changed back to "0" to return to normal mode.

## 

This section describes the procedure for backing up and restoring service mode setting information by using the [Import/Export] function in the [Settings/Registration] menu of Remote UI.

**CAUTION:**

- The service mode setting information can be backed up and restored only from the [Settings/Registration] menu on Remote UI, and the operation cannot be performed from the [Settings/Registration] menu on the Control Panel.
- In the case of backing up and restoring only the setting information of the [Settings/Registration] menu or the address book, refer to the procedure described in the e-Manual.

### ■ Limitations

The following limitations exist when backing up and restoring the service mode settings information from the [Settings/Registrations] menu of remote UI.

**A job must not be accepted during an import/export processing.**

Except for the calibration requested by the engine, a job is not allowed to be accepted during a processing. In addition, import/export must not be performed during execution of a job.

**Firmware must not be updated during an import/export processing.**

Fax cannot be received while firmware is updated during a processing. In addition, import/export must not be performed also during firmware update.

**Power must not be turned off during an import/export processing.**

If power discontinuity occurs during an import processing, a rollback processing is not performed, therefore the settings imported up to that point are reflected while the rest of the settings remain as-is.

When power discontinuity occurs during an export processing, export is not executed.

### ■ Procedure for Export from Remote UI ([System Management Settings] Menu)

Service mode setting information can be exported from the [System Management Settings] menu by setting the following service mode setting value to "1".

**1. Enter service mode, and set the following item to "1".**

- COPIER > OPTION > USER > SMD-EXPT

**NOTE:**

The [SMD-EXPT] setting can be configured either from the Control Panel or from the remote UI.

**2. Exit service mode, start remote UI, log in as a system administrator, and then select the following item:**

- [Settings/Registration] > [Import/Export] > [Export]

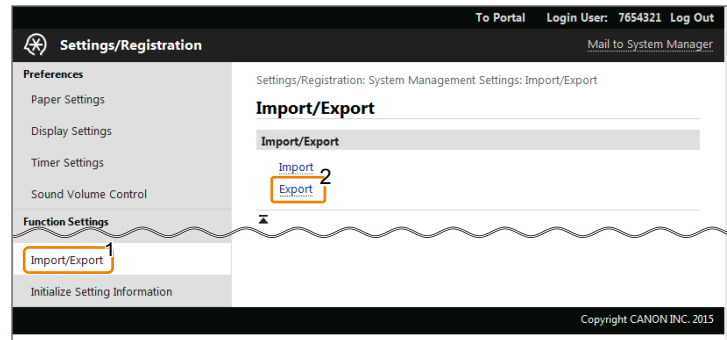

3. After confirming that [Service Mode] is displayed/selected in [Select Item to Export], enter the password and click [Start Exporting].

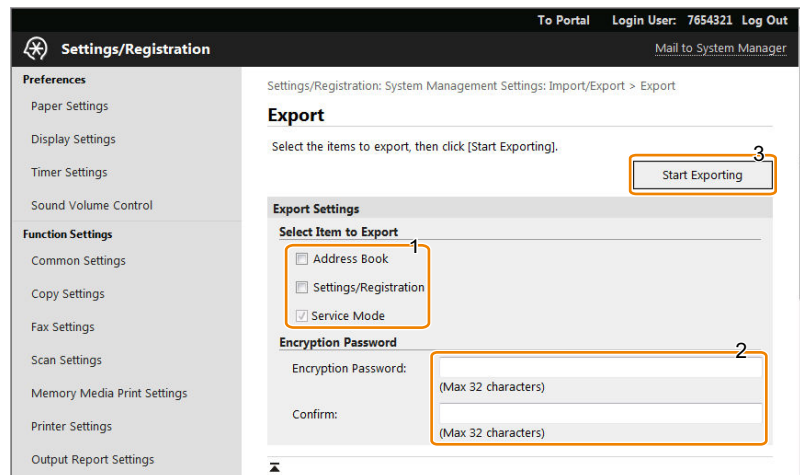

#### Address Book

Select the check box to export the address book data.

#### Settings/Registration

Select this check box to import the menu option data.

#### Encryption password

Enter 32 or less numeric characters set when the file was exported.

4. The file download dialog box will appear. Save the file to any location.
5. Enter service mode, and set the following item to "0".
- COPIER > OPTION > USER > SMD-EXPT

#### CAUTION:

Since the screen of export function can also be accessed by the user, be sure to disable the [SMD-EXPT] setting (setting value: 0).

## ■ Procedure for Import from Remote UI ([System Management Settings] Menu)

Import the service mode setting information file that was exported in the previous procedure.

1. Enter service mode, and set the following item to "1".
- COPIER > OPTION > USER > SMD-EXPT

#### NOTE:

The [SMD-EXPT] setting can be configured either from the Control Panel or from the remote UI.

2. Exit service mode, start remote UI, log in as a system administrator, and then select the following item:

- [Settings/Registration] > [Import/Export] > [Import]

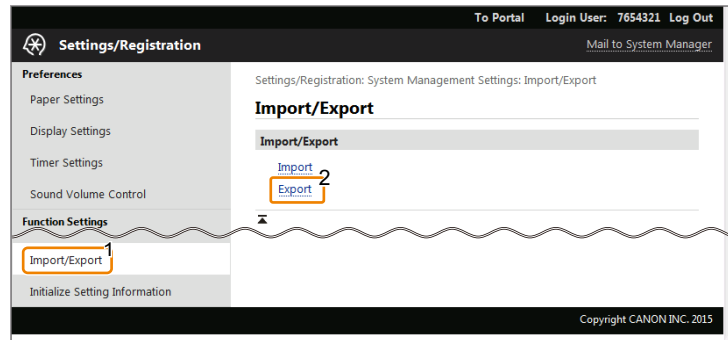

3. Configure the import settings, and click [Start Importing].

Entering the password and clicking [Start Importing] imports the menu option data.

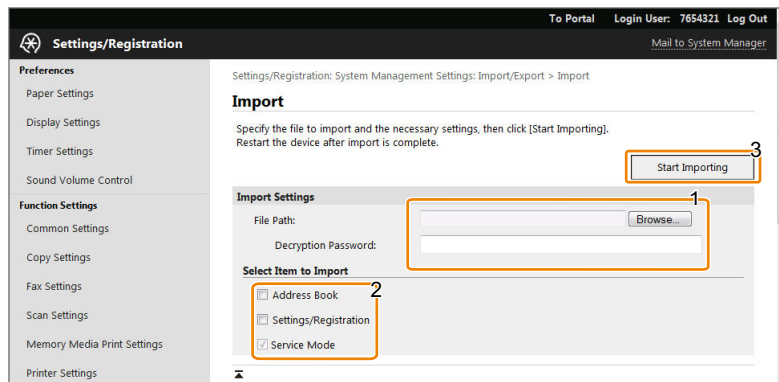

**[Browse...] button**

Click to select the file to import.

**Decryption password**

Enter 32 or less numeric characters set when the file was exported.

**Address Book**

Select the check box to import the address book data.

**Settings/Registration**

Select this check box to import the menu option data.

4. Click [OK] when a dialog box confirming whether you want to execute the import process is displayed.

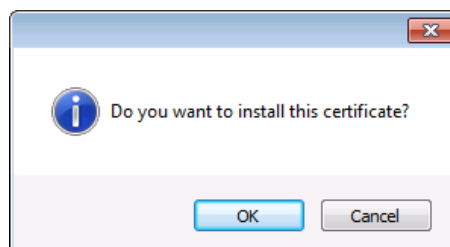

5. When a message indicating completion of the processing appears, click [OK].



6. Restart this machine, enter service mode, and confirm that the setting information is reflected. This completes the procedure for importing a setting information file.
7. Enter service mode, and set the following item to "0".
  - COPIER > OPRION > USER > SMD-EXPT

**CAUTION:**

Since the screen of export function can also be accessed by the user, be sure to disable the [SMD-EXPT] setting (setting value: 0).

## Procedure for Exporting/Importing Service Mode Setting Information

Service mode setting information can be backed up and restored by using service mode functions. The backup file can be saved to a USB flash drive or a storage in the machine.

**Backup/restoration to a USB flash drive**

COPIER > FUNCTION > SYSTEM > EXPORT  
COPIER > FUNCTION > SYSTEM > IMPORT

**Backup/restoration to a storage in the machine**

COPIER > FUNCTION > SYSTEM > SAVE-SM  
COPIER > FUNCTION > SYSTEM > RSTR-SM

	Backup/restoration to a USB flash drive	Backup/restoration to a storage in the machine
Storage destination	USB flash drive	Storage in the machine
Number of files saved	Depends on the capacity of the USB flash drive	One
Duplication of the setting values for other machines	Possible	Not possible

### ■ Procedure for Exporting to a USB Flash Drive

Use the service mode function to save the service mode setting information to a USB flash drive.

This operation can be performed both from the Control Panel and remote UI.

The following USB flash drives can be used for export/import.

- USB flash drive in FAT 16 format (storage capacity: 2 GB)
- USB flash drive in FAT 32 format (storage capacity: 32 GB)

Note that the descriptions in parenthesis in the procedure are the descriptions in the case of remote UI.

1. Connect the USB flash drive to the USB Memory Port.
2. Enter service mode, and execute the following service mode.
  - COPIER > FUNCTION > SYSTEM > EXPORT

**CAUTION:**

Even if the service mode is executed without connecting a USB flash drive, an error is not displayed. It looks as if the process has been completed successfully, but the file has not been exported to anywhere. For the reason shown above, be sure to check before execution that a USB flash drive is connected.

3. The message displayed during the process will disappear. When the display has returned to the original state, remove the USB flash drive.
4. Check that a setting information file (service.dcm) exists in the directory directly under the root of the USB flash drive.
 

This completes the export of a setting information file.

### ■ Procedure for Import from USB Flash Drive

1. Save the setting information file (service.dcm) to be imported to directly under the root of the USB flash drive.
2. Connect the USB flash drive to the USB Memory Port.

**3. Enter service mode, and execute the following service mode.**

- COPIER > FUNCTION > SYSTEM > IMPORT

**4. The message displayed during the process will disappear. When the display has returned to the original state, remove the USB flash drive.****5. Restart this machine, enter service mode, and confirm that the setting information is reflected.**

This completes the the import of a setting information file.

## ■ Backup Procedure to the Storage in the Machine

Use the service mode function to back up the service mode setting information to the storage in the machine.

This operation can be performed both from the Control Panel and remote UI.

The setting information that can be saved in the machine's storage is only one.

**1. Enter service mode, and execute the following service mode.**

- COPIER > FUNCTION > SYSTEM > SAVE-SM

**2. Backup process is complete after checking that the message displayed during the process disappears and the display returns to the original state.**

## ■ Procedure for Restoration from Internal Storage

Restore the service mode setting information that has been backed up to the storage in the machine in the previous procedure.

**1. Enter service mode, and execute the following service mode.**

- COPIER > FUNCTION > SYSTEM > RSTR-SM

**2. Restoration process is complete after checking that the message displayed during the process disappears and the display returns to the original state.**

## List of Items Which Can Be Imported

The following shows the items to be imported for this model.

Note that the setting values are not imported in cases such as below:

- Items which are originally not included in a DCM file (e.g.: "Settings/Registration Basic Information" of a DCM file exported using service mode)
- Not included in the import coverage (Cases A to C)
- There are no options and functions related to setting values

The import coverage shown in the table below is as shown below. Those that are not described here cannot be imported.

Import coverage	Description
Case A: The same machine	Import to the same machine (for backup and restoration, etc.)
Case B: The same model	Import to a different machine of the same model (the same series)
Case C: Different model	Import to a different machine of a different model (a different series)

## ■ Service Mode Settings

Initial screen	Main item	Intermediate item	Sub item	Case A	Case B	Case C
COPIER	ADJUST	FEED-ADJ	ADJ-MFY	Yes	-	-
COPIER	ADJUST	FEED-ADJ	ADJ-MFX	Yes	-	-
COPIER	ADJUST	FEED-ADJ	ADJ-MFYR	Yes	-	-
COPIER	ADJUST	FEED-ADJ	ADJ-MFXR	Yes	-	-
COPIER	ADJUST	FEED-ADJ	ADJ-C1Y	Yes	-	-
COPIER	ADJUST	FEED-ADJ	ADJ-C1X	Yes	-	-
COPIER	ADJUST	FEED-ADJ	ADJ-C1YR	Yes	-	-
COPIER	ADJUST	FEED-ADJ	ADJ-C1XR	Yes	-	-
COPIER	ADJUST	FEED-ADJ	ADJ-C2Y	Yes	-	-
COPIER	ADJUST	FEED-ADJ	ADJ-C2X	Yes	-	-
COPIER	ADJUST	FEED-ADJ	ADJ-C2YR	Yes	-	-

Initial screen	Main item	Intermediate item	Sub item	Case A	Case B	Case C
COPIER	ADJUST	FEED-ADJ	ADJ-C2XR	Yes	-	-
COPIER	ADJUST	VIFADJ	DEV-HV-Y	Yes	-	-
COPIER	ADJUST	VIFADJ	DEV-HV-M	Yes	-	-
COPIER	ADJUST	VIFADJ	DEV-HV-C	Yes	-	-
COPIER	ADJUST	VIFADJ	DEV-HV-K	Yes	-	-
COPIER	ADJUST	VIFADJ	TR1-HV-Y	Yes	-	-
COPIER	ADJUST	VIFADJ	TR1-HV-M	Yes	-	-
COPIER	ADJUST	VIFADJ	TR1-HV-C	Yes	-	-
COPIER	ADJUST	VIFADJ	TR1-HV-K	Yes	-	-
COPIER	ADJUST	VIFADJ	TR2SF-HV	Yes	-	-
COPIER	ADJUST	VIFADJ	TR2BK-HV	Yes	-	-
COPIER	ADJUST	VIFADJ	ICL-HV	Yes	-	-
COPIER	ADJUST	VIFADJ	FU-TMP	Yes	-	-
COPIER	ADJUST	SCNR	SUB-S-Y0	Yes	-	-
COPIER	ADJUST	SCNR	SUB-S-M0	Yes	-	-
COPIER	ADJUST	SCNR	SUB-S-C0	Yes	-	-
COPIER	ADJUST	SCNR	SUB-S-K0	Yes	-	-
COPIER	ADJUST	SCNR	SUB-S-Y1	Yes	-	-
COPIER	ADJUST	SCNR	SUB-S-M1	Yes	-	-
COPIER	ADJUST	SCNR	SUB-S-C1	Yes	-	-
COPIER	ADJUST	SCNR	SUB-S-K1	Yes	-	-
COPIER	ADJUST	SCNR	SUB-S-Y2	Yes	-	-
COPIER	ADJUST	SCNR	SUB-S-M2	Yes	-	-
COPIER	ADJUST	SCNR	SUB-S-C2	Yes	-	-
COPIER	ADJUST	SCNR	SUB-S-K2	Yes	-	-
COPIER	ADJUST	SCNR	MAI-S-Y0	Yes	-	-
COPIER	ADJUST	SCNR	MAI-S-M0	Yes	-	-
COPIER	ADJUST	SCNR	MAI-S-C0	Yes	-	-
COPIER	ADJUST	SCNR	MAI-S-K0	Yes	-	-
COPIER	ADJUST	SCNR	MAI-S-Y1	Yes	-	-
COPIER	ADJUST	SCNR	MAI-S-M1	Yes	-	-
COPIER	ADJUST	SCNR	MAI-S-C1	Yes	-	-
COPIER	ADJUST	SCNR	MAI-S-K1	Yes	-	-
COPIER	ADJUST	SCNR	MAI-S-Y2	Yes	-	-
COPIER	ADJUST	SCNR	MAI-S-M2	Yes	-	-
COPIER	ADJUST	SCNR	MAI-S-C2	Yes	-	-
COPIER	ADJUST	SCNR	MAI-S-K2	Yes	-	-
COPIER	FUNCTION	VIFFNC	SMEAR-PV	Yes	-	-
COPIER	FUNCTION	VIFFNC	FEED-IMP	Yes	-	-
COPIER	FUNCTION	VIFFNC	FOG-PV	Yes	-	-
COPIER	FUNCTION	VIFFNC	ICL-IMP	Yes	-	-
COPIER	FUNCTION	SPLMAN	SPL14159	Yes	Yes	Yes
COPIER	FUNCTION	SPLMAN	SPL37510	Yes	-	-
COPIER	FUNCTION	SPLMAN	SPL65677	Yes	-	-
COPIER	FUNCTION	SPLMAN	SPL68676	Yes	-	-
COPIER	FUNCTION	SPLMAN	SPL68677	Yes	-	-
COPIER	FUNCTION	SPLMAN	SPL25607	Yes	-	-
COPIER	FUNCTION	SPLMAN	SPL93822	Yes	Yes	Yes
COPIER	FUNCTION	SPLMAN	SPL78788	Yes	Yes	Yes
COPIER	FUNCTION	SPLMAN	SPL71100 *1	Yes	-	-
COPIER	FUNCTION	SPLMAN	SPL00171	Yes	Yes	Yes

\*1. FAX model only

Initial screen	Main item	Intermediate item	Sub item	Case A	Case B	Case C
COPIER	FUNCTION	SPLMAN	SPL80100	Yes	Yes	Yes
COPIER	FUNCTION	SPLMAN	SPL84194	Yes	Yes	Yes
COPIER	FUNCTION	INSTALL	ERDS	Yes	Yes	Yes
COPIER	FUNCTION	INSTALL	RGW-PORT	Yes	Yes	Yes
COPIER	OPTION	BODY	MIBCOUNT	Yes	Yes	Yes
COPIER	OPTION	BODY	NS-CMD5	Yes	-	-
COPIER	OPTION	BODY	NS-PLN	Yes	-	-
COPIER	OPTION	BODY	NS-LGN	Yes	-	-
COPIER	OPTION	BODY	SLPMODE	Yes	Yes	Yes
COPIER	OPTION	BODY	SDTM-DSP	Yes	Yes	Yes
COPIER	OPTION	FNC-SW	IMGCNTPR	Yes	Yes	Yes
COPIER	OPTION	FNC-SW	LCDSFLG	Yes	Yes	Yes
COPIER	OPTION	FNC-SW	CRG-PROC	Yes	Yes	-
COPIER	OPTION	FNC-SW	CRGLF-K	Yes	Yes	-
COPIER	OPTION	FNC-SW	CRGLF-CL	Yes	Yes	-
COPIER	OPTION	DSPLY-SW	CRGLW-LV	Yes	Yes	Yes
COPIER	OPTION	IMG-MCON	TMIC-BK	Yes	-	-
COPIER	OPTION	IMG-MCON	TMIC-CMY	Yes	-	-
COPIER	OPTION	USER	CTCHKDSP	Yes	-	-
COPIER	OPTION	USER	TNRB-SW	Yes	-	-
COPIER	OPTION	USER	SMD-EXPT	Yes	-	-
COPIER	OPTION	USER	ACC-SLP	Yes	Yes	Yes
Fax	SSSW	SW01 *1	-	Yes	-	-
Fax	SSSW	SW02 *1	-	Yes	-	-
Fax	SSSW	SW03 *1	-	Yes	-	-
Fax	SSSW	SW04 *1	-	Yes	-	-
Fax	SSSW	SW05 *1	-	Yes	-	-
Fax	SSSW	SW06 *1	-	Yes	-	-
Fax	SSSW	SW07 *1	-	Yes	-	-
Fax	SSSW	SW08 *1	-	Yes	-	-
Fax	SSSW	SW09 *1	-	Yes	-	-
Fax	SSSW	SW10 *1	-	Yes	-	-
Fax	SSSW	SW11 *1	-	Yes	-	-
Fax	SSSW	SW12 *1	-	Yes	-	-
Fax	SSSW	SW13 *1	-	Yes	-	-
Fax	SSSW	SW14 *1	-	Yes	-	-
Fax	SSSW	SW15 *1	-	Yes	-	-
Fax	SSSW	SW16 *1	-	Yes	-	-
Fax	SSSW	SW17 *1	-	Yes	-	-
Fax	SSSW	SW18 *1	-	Yes	-	-
Fax	SSSW	SW19 *1	-	Yes	-	-
Fax	SSSW	SW20 *1	-	Yes	-	-
Fax	SSSW	SW21 *1	-	Yes	-	-
Fax	SSSW	SW22 *1	-	Yes	-	-
Fax	SSSW	SW23 *1	-	Yes	-	-
Fax	SSSW	SW24 *1	-	Yes	-	-
Fax	SSSW	SW25 *1	-	Yes	-	-
Fax	SSSW	SW26 *1	-	Yes	-	-
Fax	SSSW	SW27 *1	-	Yes	-	-

\*1. FAX model only

Initial screen	Main item	Intermediate item	Sub item	Case A	Case B	Case C
Fax	SSSW	SW28 <sup>*1</sup>	-	Yes	-	-
Fax	SSSW	SW29 <sup>*1</sup>	-	Yes	-	-
Fax	SSSW	SW30 <sup>*1</sup>	-	Yes	-	-
Fax	SSSW	SW31 <sup>*1</sup>	-	Yes	-	-
Fax	SSSW	SW32 <sup>*1</sup>	-	Yes	-	-
Fax	MENU	005 <sup>*1</sup>	-	Yes	-	-
Fax	MENU	006 <sup>*1</sup>	-	Yes	-	-
Fax	MENU	007 <sup>*1</sup>	-	Yes	-	-
Fax	MENU	008 <sup>*1</sup>	-	Yes	-	-
Fax	MENU	009 <sup>*1</sup>	-	Yes	-	-
Fax	MENU	010 <sup>*1</sup>	-	Yes	-	-
Fax	NUM	002 <sup>*1</sup>	-	Yes	-	-
Fax	NUM	003 <sup>*1</sup>	-	Yes	-	-
Fax	NUM	004 <sup>*1</sup>	-	Yes	-	-
Fax	NUM	005 <sup>*1</sup>	-	Yes	-	-
Fax	NUM	006 <sup>*1</sup>	-	Yes	-	-
Fax	NUM	008 <sup>*1</sup>	-	Yes	-	-
Fax	NUM	010 <sup>*1</sup>	-	Yes	-	-
Fax	NUM	011 <sup>*1</sup>	-	Yes	-	-
Fax	NUM	012 <sup>*1</sup>	-	Yes	-	-
Fax	NUM	013 <sup>*1</sup>	-	Yes	-	-
Fax	NUM	015 <sup>*1</sup>	-	Yes	-	-
Fax	NUM	016 <sup>*1</sup>	-	Yes	-	-
Fax	NUM	017 <sup>*1</sup>	-	Yes	-	-
Fax	NUM	018 <sup>*1</sup>	-	Yes	-	-
Fax	NUM	019 <sup>*1</sup>	-	Yes	-	-
Fax	NUM	020 <sup>*1</sup>	-	Yes	-	-
Fax	NUM	021 <sup>*1</sup>	-	Yes	-	-
Fax	NUM	022 <sup>*1</sup>	-	Yes	-	-
Fax	NUM	023 <sup>*1</sup>	-	Yes	-	-
Fax	NUM	024 <sup>*1</sup>	-	Yes	-	-
Fax	NUM	025 <sup>*1</sup>	-	Yes	-	-
Fax	NUM	026 <sup>*1</sup>	-	Yes	-	-
Fax	NUM	027 <sup>*1</sup>	-	Yes	-	-
Fax	NUM	029 <sup>*1</sup>	-	Yes	-	-
Fax	NUM	049 <sup>*1</sup>	-	Yes	-	-
Fax	NUM	051 <sup>*1</sup>	-	Yes	-	-
Fax	NUM	053 <sup>*1</sup>	-	Yes	-	-
Fax	NUM	054 <sup>*1</sup>	-	Yes	-	-
Fax	NCU	TONE	001 <sup>*1</sup>	Yes	-	-
Fax	NCU	TONE	002 <sup>*1</sup>	Yes	-	-
Fax	NCU	PULSE	FORM <sup>*1</sup>	Yes	-	-
Fax	NCU	PULSE	001 <sup>*1</sup>	Yes	-	-
Fax	NCU	PULSE	002 <sup>*1</sup>	Yes	-	-
Fax	NCU	PULSE	003 <sup>*1</sup>	Yes	-	-
Fax	NCU	PULSE	004 <sup>*1</sup>	Yes	-	-
Fax	NCU	DIALTONE	BIT <sup>*1</sup>	Yes	-	-

\*1. FAX model only



Initial screen	Main item	Intermediate item	Sub item	Case A	Case B	Case C
Fax	NCU	DIALTONE	001 *1	Yes	-	-
Fax	NCU	DIALTONE	002 *1	Yes	-	-
Fax	NCU	DIALTONE	003 *1	Yes	-	-
Fax	NCU	DIALTONE	004 *1	Yes	-	-
Fax	NCU	DIALTONE	005 *1	Yes	-	-
Fax	NCU	DIALTONE	006 *1	Yes	-	-
Fax	NCU	DIALTONE	007 *1	Yes	-	-
Fax	NCU	DIALTONE	008 *1	Yes	-	-
Fax	NCU	2ND DLTN	BIT *1	Yes	-	-
Fax	NCU	2ND DLTN	001 *1	Yes	-	-
Fax	NCU	2ND DLTN	002 *1	Yes	-	-
Fax	NCU	2ND DLTN	003 *1	Yes	-	-
Fax	NCU	2ND DLTN	004 *1	Yes	-	-
Fax	NCU	2ND DLTN	005 *1	Yes	-	-
Fax	NCU	2ND DLTN	006 *1	Yes	-	-
Fax	NCU	2ND DLTN	007 *1	Yes	-	-
Fax	NCU	2ND DLTN	008 *1	Yes	-	-
Fax	NCU	BUSTONE0	BIT *1	Yes	-	-
Fax	NCU	BUSTONE0	001 *1	Yes	-	-
Fax	NCU	BUSTONE0	002 *1	Yes	-	-
Fax	NCU	BUSTONE0	003 *1	Yes	-	-
Fax	NCU	BUSTONE0	004 *1	Yes	-	-
Fax	NCU	BUSTONE0	005 *1	Yes	-	-
Fax	NCU	BUSTONE0	006 *1	Yes	-	-
Fax	NCU	BUSTONE0	007 *1	Yes	-	-
Fax	NCU	BUSTONE0	008 *1	Yes	-	-
Fax	NCU	BUSTONE1	BIT *1	Yes	-	-
Fax	NCU	BUSTONE1	001 *1	Yes	-	-
Fax	NCU	BUSTONE1	002 *1	Yes	-	-
Fax	NCU	BUSTONE1	003 *1	Yes	-	-
Fax	NCU	BUSTONE1	004 *1	Yes	-	-
Fax	NCU	BUSTONE1	005 *1	Yes	-	-
Fax	NCU	BUSTONE1	006 *1	Yes	-	-
Fax	NCU	BUSTONE1	007 *1	Yes	-	-
Fax	NCU	BUSTONE1	008 *1	Yes	-	-
Fax	NCU	REORDRTN	BIT *1	Yes	-	-
Fax	NCU	REORDRTN	001 *1	Yes	-	-
Fax	NCU	REORDRTN	002 *1	Yes	-	-
Fax	NCU	REORDRTN	003 *1	Yes	-	-
Fax	NCU	REORDRTN	004 *1	Yes	-	-
Fax	NCU	REORDRTN	005 *1	Yes	-	-
Fax	NCU	REORDRTN	006 *1	Yes	-	-
Fax	NCU	REORDRTN	007 *1	Yes	-	-
Fax	NCU	REORDRTN	008 *1	Yes	-	-
Fax	NCU	AUTO RX	001 *1	Yes	-	-
Fax	NCU	AUTO RX	002 *1	Yes	-	-
Fax	NCU	AUTO RX	003 *1	Yes	-	-

\*1. FAX model only

Initial screen	Main item	Intermediate item	Sub item	Case A	Case B	Case C
Fax	NCU	AUTO RX	004 *1	Yes	-	-
Fax	NCU	AUTO RX	005 *1	Yes	-	-
Fax	NCU	AUTO RX	006 *1	Yes	-	-
Fax	NCU	AUTO RX	007 *1	Yes	-	-
Fax	NCU	AUTO RX	008 *1	Yes	-	-
Fax	NCU	AUTO RX	009 *1	Yes	-	-
Fax	NCU	CNGDTCT	001 *1	Yes	-	-
Fax	NCU	CNGDTCT	002 *1	Yes	-	-
Fax	NCU	CNGDTCT	006 *1	Yes	-	-
Fax	NCU	CNGDTCT	007 *1	Yes	-	-
Fax	NCU	CNGDTCT	008 *1	Yes	-	-
Fax	NCU	CNGDTCT	009 *1	Yes	-	-
Fax	NCU	CNGDTCT	011 *1	Yes	-	-
Fax	NCU	CNGDTCT	012 *1	Yes	-	-
Fax	NCU	SPECIALB	SW01 *1	Yes	-	-
Fax	NCU	SPECIALB	SW02 *1	Yes	-	-
Fax	NCU	SPECIALB	SW03 *1	Yes	-	-
Fax	NCU	SPECIALB	SW04 *1	Yes	-	-
Fax	NCU	SPECIALB	SW05 *1	Yes	-	-
Fax	NCU	SPECIALB	SW06 *1	Yes	-	-
Fax	NCU	SPECIALB	SW07 *1	Yes	-	-
Fax	NCU	SPECIALB	SW08 *1	Yes	-	-
Fax	NCU	SPECIALB	SW09 *1	Yes	-	-
Fax	NCU	SPECIALB	SW10 *1	Yes	-	-
Fax	NCU	SPECIALB	SW11 *1	Yes	-	-
Fax	NCU	SPECIALB	SW12 *1	Yes	-	-
Fax	NCU	SPECIALB	SW13 *1	Yes	-	-
Fax	NCU	SPECIALB	SW14 *1	Yes	-	-
Fax	NCU	SPECIALB	SW15 *1	Yes	-	-
Fax	NCU	SPECIALB	SW16 *1	Yes	-	-
Fax	NCU	SPECIALB	SW17 *1	Yes	-	-
Fax	NCU	SPECIALB	SW18 *1	Yes	-	-
Fax	NCU	SPECIALB	SW19 *1	Yes	-	-
Fax	NCU	SPECIALB	SW20 *1	Yes	-	-
Fax	NCU	SPECIALB	SW21 *1	Yes	-	-
Fax	NCU	SPECIALB	SW22 *1	Yes	-	-
Fax	NCU	SPECIALB	SW23 *1	Yes	-	-
Fax	NCU	SPECIALB	SW24 *1	Yes	-	-
Fax	NCU	SPECIALB	SW25 *1	Yes	-	-
Fax	NCU	SPECIALB	SW26 *1	Yes	-	-
Fax	NCU	SPECIALB	SW27 *1	Yes	-	-
Fax	NCU	SPECIALB	SW28 *1	Yes	-	-
Fax	NCU	SPECIALB	SW29 *1	Yes	-	-
Fax	NCU	SPECIALB	SW30 *1	Yes	-	-
Fax	NCU	SPECIALLN	004 *1	Yes	-	-
Fax	NCU	SPECIALLN	005 *1	Yes	-	-
Fax	NCU	SPECIALLN	006 *1	Yes	-	-

\*1. FAX model only

Initial screen	Main item	Intermediate item	Sub item	Case A	Case B	Case C
Fax	NCU	SPECIALN	007 *1	Yes	-	-
Fax	NCU	SPECIALN	008 *1	Yes	-	-
Fax	NCU	SPECIALN	009 *1	Yes	-	-
Fax	NCU	SPECIALN	011 *1	Yes	-	-
Fax	NCU	SPECIALN	012 *1	Yes	-	-
Fax	NCU	SPECIALN	013 *1	Yes	-	-
Fax	NCU	SPECIALN	014 *1	Yes	-	-
Fax	NCU	SPECIALN	015 *1	Yes	-	-
Fax	NCU	SPECIALN	016 *1	Yes	-	-
Fax	NCU	SPECIALN	017 *1	Yes	-	-
Fax	NCU	SPECIALN	019 *1	Yes	-	-
Fax	NCU	SPECIALN	020 *1	Yes	-	-
Fax	NCU	SPECIALN	024 *1	Yes	-	-
Fax	NCU	SPECIALN	025 *1	Yes	-	-
Fax	NCU	SPECIALN	026 *1	Yes	-	-
Fax	NCU	SPECIALN	027 *1	Yes	-	-
Fax	NCU	SPECIALN	030 *1	Yes	-	-
Fax	NCU	SPECIALN	040 *1	Yes	-	-
Fax	NCU	SPECIALN	041 *1	Yes	-	-
Fax	NCU	SPECIALN	042 *1	Yes	-	-
Fax	NCU	SPECIALN	044 *1	Yes	-	-
Fax	NCU	SPECIALN	045 *1	Yes	-	-
Fax	NCU	SPECIALN	046 *1	Yes	-	-
Fax	NCU	SPECIALN	047 *1	Yes	-	-
Fax	NCU	SPECIALN	048 *1	Yes	-	-
Fax	NCU	SPECIALN	065 *1	Yes	-	-
Fax	NCU	SPECIALN	066 *1	Yes	-	-
Fax	NCU	RKEY	001 *1	Yes	-	-
Fax	NCU	RKEY	002 *1	Yes	-	-
Fax	NCU	PBXDIALT	BIT *1	Yes	-	-
Fax	NCU	PBXDIALT	001 *1	Yes	-	-
Fax	NCU	PBXDIALT	002 *1	Yes	-	-
Fax	NCU	PBXDIALT	003 *1	Yes	-	-
Fax	NCU	PBXDIALT	004 *1	Yes	-	-
Fax	NCU	PBXDIALT	005 *1	Yes	-	-
Fax	NCU	PBXDIALT	006 *1	Yes	-	-
Fax	NCU	PBXDIALT	007 *1	Yes	-	-
Fax	NCU	PBXDIALT	008 *1	Yes	-	-
Fax	NCU	PBXBUSYT	BIT *1	Yes	-	-
Fax	NCU	PBXBUSYT	001 *1	Yes	-	-
Fax	NCU	PBXBUSYT	002 *1	Yes	-	-
Fax	NCU	PBXBUSYT	003 *1	Yes	-	-
Fax	NCU	PBXBUSYT	004 *1	Yes	-	-
Fax	NCU	PBXBUSYT	005 *1	Yes	-	-
Fax	NCU	PBXBUSYT	006 *1	Yes	-	-
Fax	NCU	PBXBUSYT	007 *1	Yes	-	-
Fax	NCU	PBXBUSYT	008 *1	Yes	-	-

\*1. FAX model only

## Monitoring Function (e-Maintenance/imageWARE Remote)

### Overview of System

#### Function Overview

E-RDS (Embedded RDS) is a monitoring program that runs on the host machine. When the monitoring option is enabled by making the setting on this machine, information such as the status change of the machine, counter information, and failure information are collected. The collected device information is sent to a remote maintenance server called UGW (Universal Gateway Server) via Internet.

The information to be monitored is:

- Billing counter
- Parts counter
- ROM version
- Service call error log
- Jam log
- Alarm log
- Change of status (such as status of consumables)

Since the information shown above is customer information, HTTPS/ SOAP protocol is used for communication between the UGW server and the host machine to improve security.

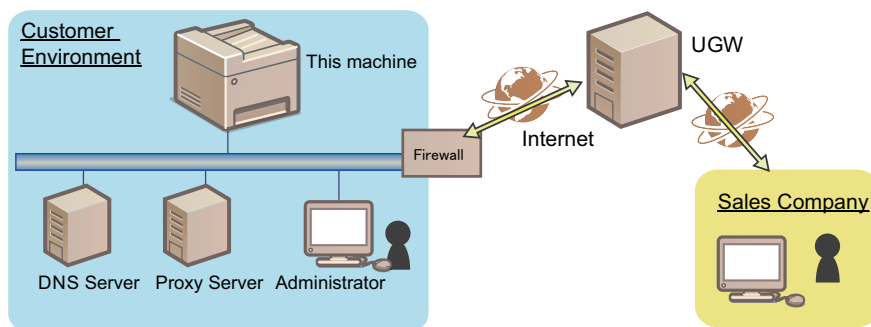

#### Features

E-RDS is embedded in the network module of the device, and the front-end module of the e-Maintenance/ imageWARE Remote system is realized without requiring hardware besides the device.

#### Main Functions

Functional category	Sub category	Description
Communication Test	Test	By executing the following service mode, E-RDS communicates with UGW, retrieves schedule information, and establish communication. COPIER > FUNCTION > INSTALL > COM-TEST
Transmission of counters	Billing/all resources/parts/mode-by-mode counters	E-RDS Periodically send billing/all resources/parts/mode-by-mode counters to the server.
Transmission of event logs	Service call/alarm/jam log	Each time a service call, alarm, or jam log occurs, the error log is sent to the server. Having alarm log or not is different by a model.
Data transmission	ROM version / Device configuration	E-RDS periodically sends the firmware information of the device to UGW. E-RDS sends the device configuration information only when there is any change in the configuration.
	E-RDS Debug log	Debug logs of E-RDS are stored in E-RDS, and they are sent to UGW only when they exceed a specific size.
	Sublog transmission	When E-RDS catches the sublog transmission of a message designation than UGW, send data such as device Sublogs and DCON logs to the server.
Operation instruction	Operation check	E-RDS contacts UGW to check if there is processing to be executed next, and receives the following instructions if any. <ul style="list-style-type: none"> <li>• Linkage with CDS</li> <li>• Sublog transmission</li> </ul>

## ● Servicing Notes

- After clearing the Main Controller PCB, initialization of the E-RDS setting (ERDS-DAT) and a communication test (COM-TEST) need to be performed. If this work is omitted, an error may occur when counters are sent to UGW. After replacing the Main Controller PCB, all the settings need to be reconfigured.
- Do not change the values of the following service modes unless otherwise instructed. If they are changed, a communication error will occur with UGW.
  - Port number of UGW  
[COPIER] > [FUNCTION] > [INSTALL] > [RGW-PORT]  
Default: 443
- If the e-Maintenance/imageWARE Remote contract of the device becomes invalid, be sure to turn OFF the E-RDS setting (E-RDS: 0).
- When the E-RDS function is enabled, a communication test can be performed from [Check Counter] of the Control Panel of the host machine. <sup>\*1</sup>  
When conducting a communication test from [Check Counter], pay attention to the following points:
  - During a communication test, do not take any actions such as pressing a key. Actions are not accepted until the communication test is completed (actions are ignored).
  - When a communication test is being conducted from service mode or from [Check Counter], do not conduct a communication test from the other. This operation is not guaranteed.

## ● Setting Procedure

### ■ Preparation

Since this function communicates with the UGW server, it is necessary to connect to the external network. Check the following items, and make the settings if not yet set.

- IP address settings
- DNS server settings
- Proxy server settings<sup>\*2</sup>
- Installation of CA certificate (arbitrary <sup>\*3</sup>)

#### CAUTION:

- Obtain the information on the network environment from the system administrator of the user.
- When having changed the network settings, turn OFF and then ON the main power of the machine.

### ■ Procedure for Setting E-RDS

#### 1. In the following service mode, select the following service mode to initialize the E-RDS setting values:

- COPIER > FUNCTION > CLEAR > ERDS-DAT

#### NOTE:

This operation initializes the E-RDS settings to factory setting values.  
For the setting values to be initialized, see the section of "Setting values and data to be initialized" on page 62 .

#### 2. Enable the E-RDS function in the following service mode, and perform a communication test.

1. Select the following item:
  - COPIER > FUNCTION > INSTALL > ERDS

<sup>\*1</sup>. The user can perform a communication test or browse the result of communication test.  
If the communication results in failure, an error code (hexadecimal number, 8 digit) is displayed on the Control Panel.

<sup>\*2</sup>. If authentication is necessary, make the settings of the authentication information as well.

<sup>\*3</sup>. When using a certificate other than those pre-installed in the device

2. Enter [1] from the keyboard, and press [Apply].

**CAUTION:**

The following settings i.e. RGW-PORT in Service mode must not be change unless there are specific instructions to do so. Changing these values will cause error in communication with UGW.

When the E-RDS function is enabled, the function to communicate with UGW is enabled.

3. **Select [COM-TEST] and then touch [Yes].**

If the communication is successful, "OK" is displayed. If "NG" is displayed, check the network settings and USW server address (URL).

**CAUTION:**

The communication results with UGW can be distinguished by referring to the COM-LOG. By performing the communication test with UGW, E-RDS acquires schedule information and starts monitoring and meter reads operation.

## Maintenance

### ■ Initializing E-RDS settings

It is possible to clear the FLASH data of E-RDS and change the E-RDS setting back to the default value.

#### ● Initialization procedure

Follow the procedure shown below to initialize E-RDS.

1. **Enter service mode as a system administrator user.**
2. **Select the following service mode, and press [OK] to execute.**
  - COPIER > Function > CLEAR > ERDS-DAT

#### ● Setting values and data to be initialized

The following E-RDS settings, internal data, and Alarm filtering information are initialized.

- COPIER > FUNCTION > INSTALL > ERDS
- COPIER > FUNCTION > INSTALL > RGW-PORT
- COPIER > FUNCTION > INSTALL > COM-LOG

**CAUTION:**

If a certificate other than the CA certificate at the time of shipment has been installed, initializing the E-RDS setting will not change the settings back to those at the time of shipment. To change the certificate back to the CA certificate at the time of shipment, delete the certificate (install the CA certificate at the time of shipment) after initializing the E-RDS settings.

### ■ Report Output of Communication Error Log (COM-LOG)

A report of communication error log information on five affairs can be output.

#### ● Report output procedure

1. **Select the following service mode, and press [Yes].**
  - COPIER > FUNCTION > MISC-P > ERDS-LOG

```
12/09 2015 10:14AM
*****
*** E-RDS-COM-LOG***
*****
No.01  DATE    12/09 2015      TIME 03:21 AM   CODE 05000003
Information  SUSPEND: Communication test is not performed.
No.02  DATE    12/09 2015      TIME 03:21 AM   CODE 00000000
Information  SUSPEND: mode changed.
No.03  DATE    12/09 2015      TIME 03:18 AM   CODE 05000003
Information  SUSPEND: Communication test is not performed.
No.04  DATE    12/09 2015      TIME 03:18 AM   CODE 00000000
Information  SUSPEND: mode changed.
No.05  DATE    12/09 2015      TIME 01:56 AM   CODE 05000003
Information  SUSPEND: Communication test is not performed.
```

Output sample



# Periodical Service

Periodically Replaced Parts.....	65
Consumable Parts.....	66
Periodical Services.....	67



## Periodically Replaced Parts

This machine does not have any periodically replaced parts.

## Consumable Parts

This machine does not have any consumable parts.

## Periodical Services

This machine does not require any periodical service.



# Parts Replacement and Cleaning

List of Parts.....	69
External Cover System.....	75
Controller System.....	87
Laser Exposure System.....	101
Image Formation System.....	107
Fixing System.....	116
Pickup Feed Delivery System.....	120

## List of Parts

### Major Units

#### Host Machine

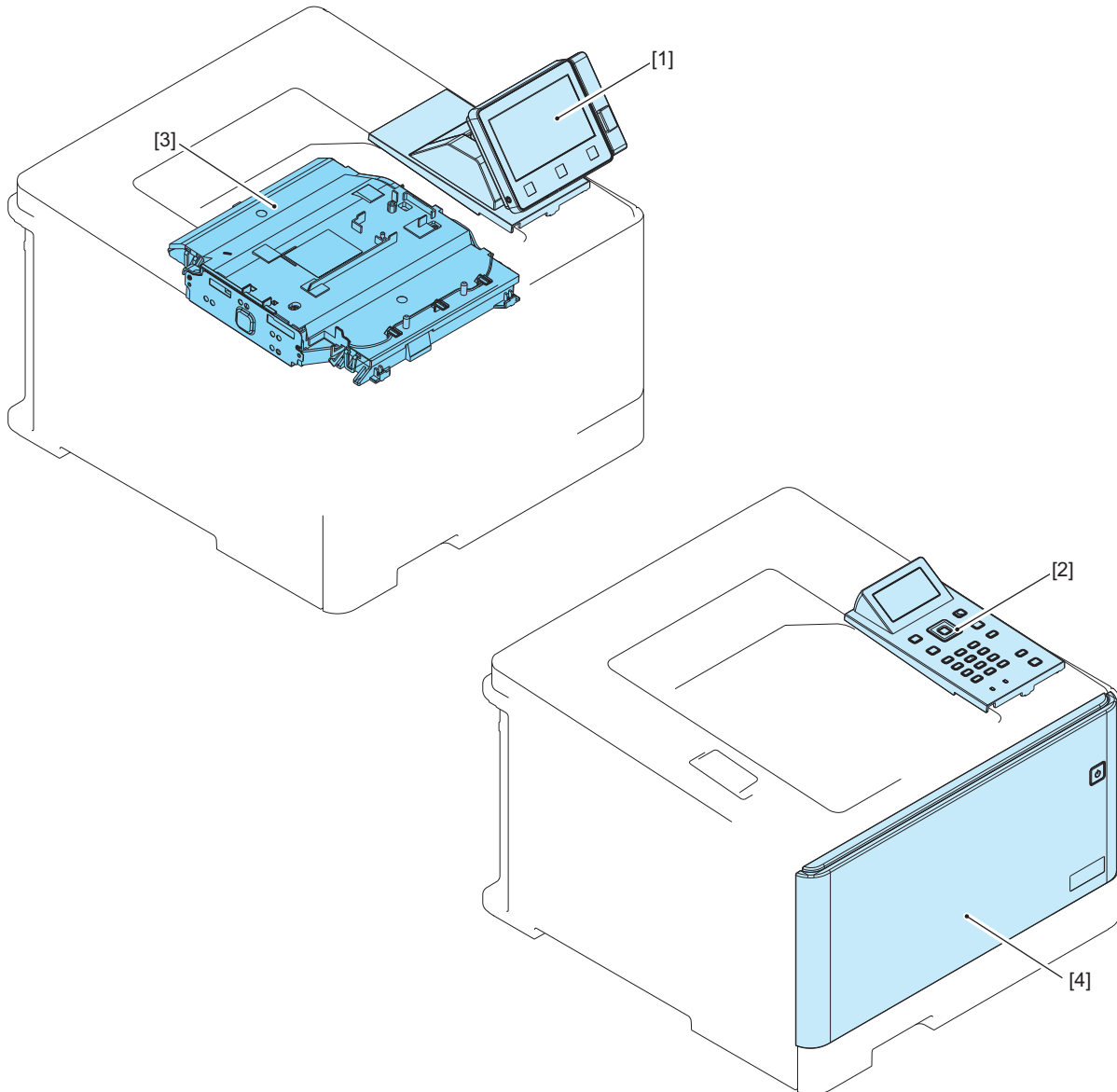

No.	Name
[1]	Control Panel Unit
[2]	5-line Control Panel Unit
[3]	Laser Scanner Unit
[4]	Cartridge Cover

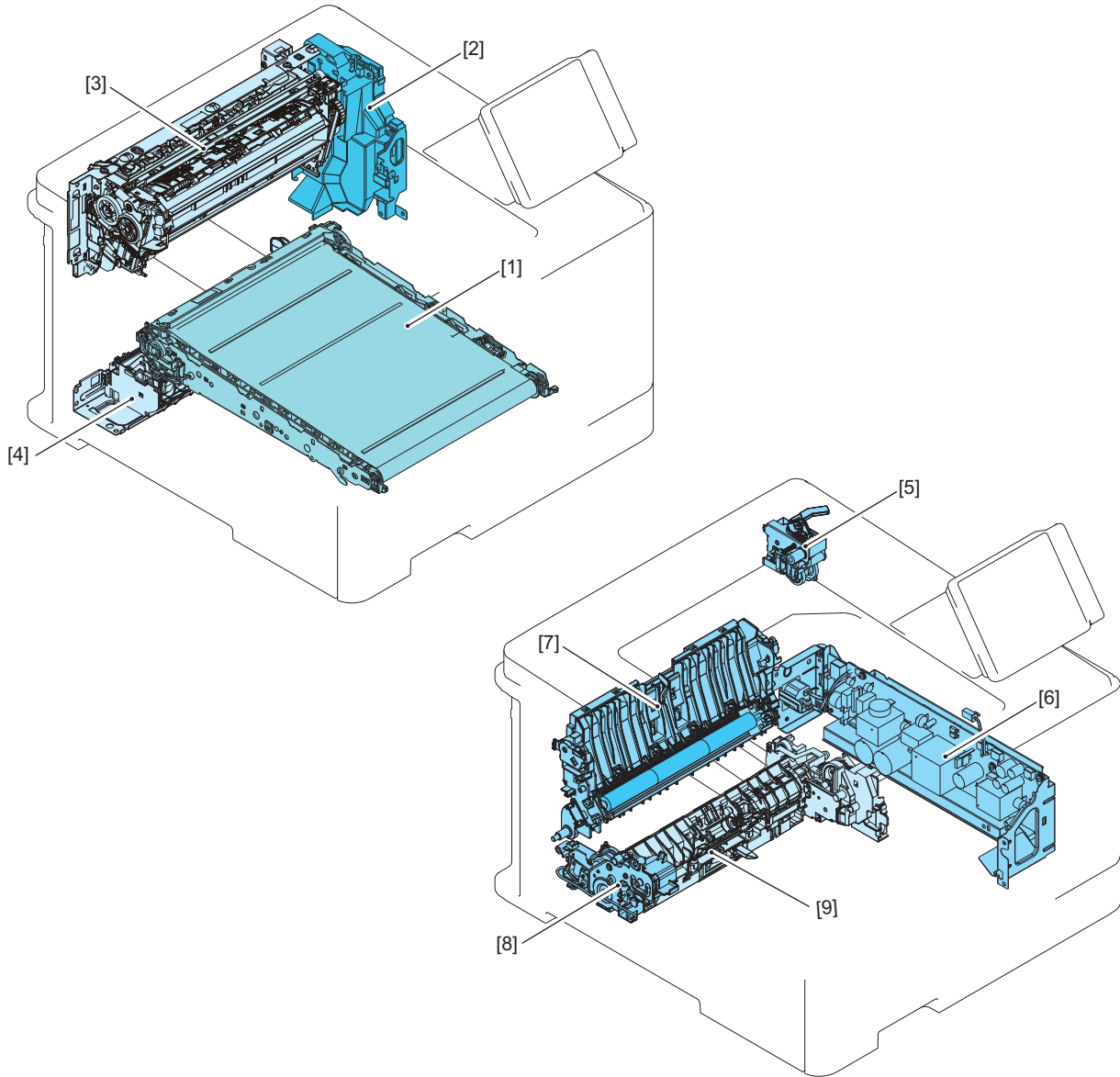

No.	Name
[1]	ITB Unit
[2]	Fixing Power Supply Unit
[3]	Fixing Assembly
[4]	Re-Pickup Unit
[5]	Duplex Reverse Drive Unit
[6]	Low Voltage Power Supply Unit
[7]	Secondary Transfer Feed Unit
[8]	Lifter Drive Unit
[9]	Cassette Pickup Unit

## Layout Drawing of Electrical Components

### ■ Motor/Fan

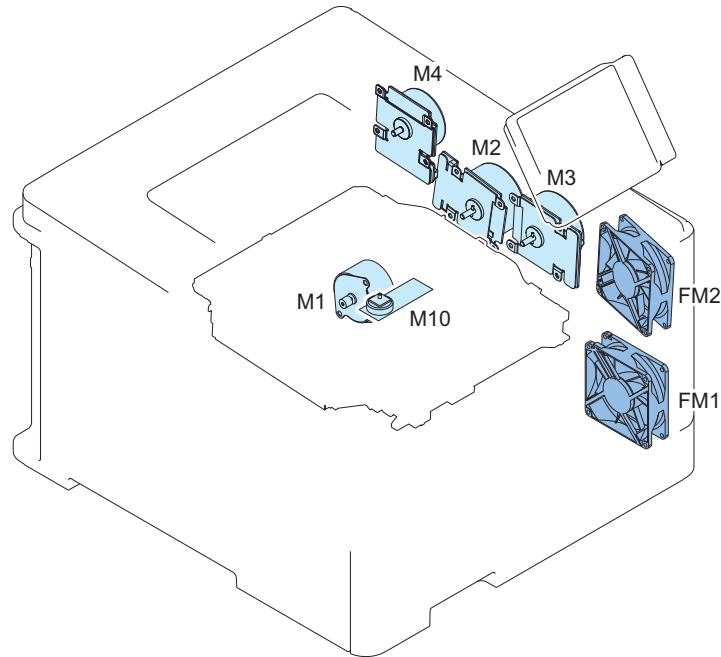

Electric code	Name
M1	Pickup Motor
M2	Drum Motor
M3	Developing Motor
M4	Fixing Motor
M10	Scanner Motor
FM1	Power Supply Fan
FM2	Cartridge Fan

### ■ Heater

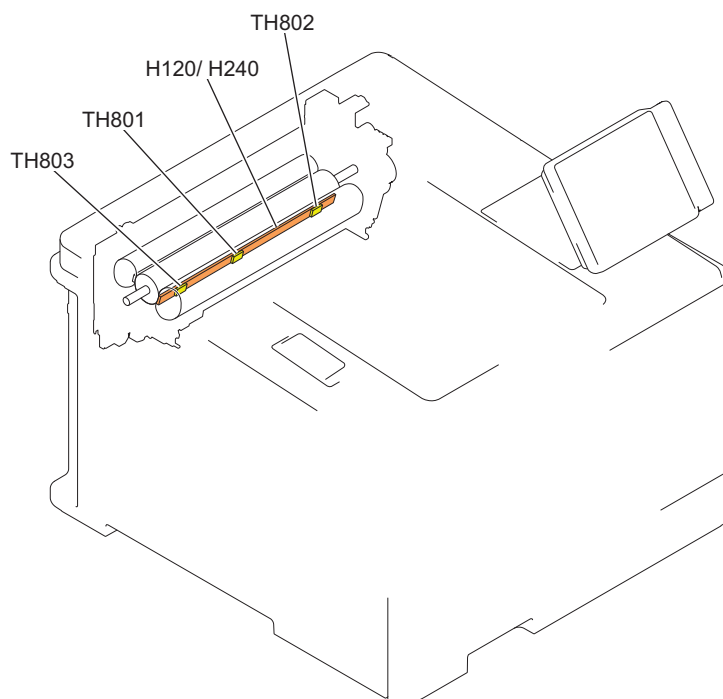

Electric code	Name
H120	Heater (120V)
H240	Heater (240V)
TH801	Main Thermistor
TH802	Sub Thermistor 1
TH803	Sub Thermistor 2

## ■ Switch/Solenoid/Clutch

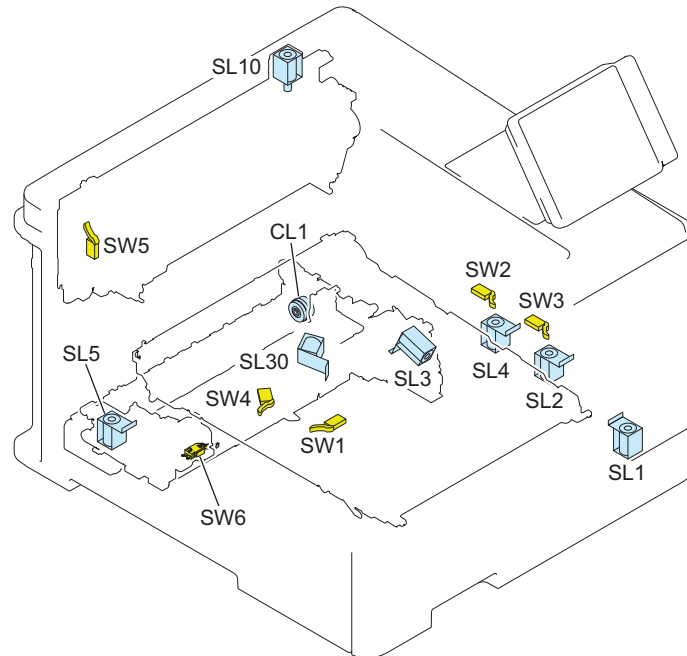

Electric code	Name
CL1	Duplex Re-pickup Clutch
SL1	MP Tray Pickup Solenoid
SL2	Developing Disengagement Solenoid (Bk)
SL3	Cassette Pickup Solenoid
SL4	Developing Disengagement Solenoid (Color)
SL5	Lifter Solenoid
SL10	Duplex Reverse Solenoid
SL30	Primary Transfer Disengagement Solenoid
SW1	Front Door Switch
SW2	Developing Disengagement Switch (Color)
SW3	Developing Disengagement Switch (Bk)
SW4	Primary Transfer Disengagement Switch
SW5	Fixing Pressure Release Switch
SW6	Cassette Switch



## ■ Sensor

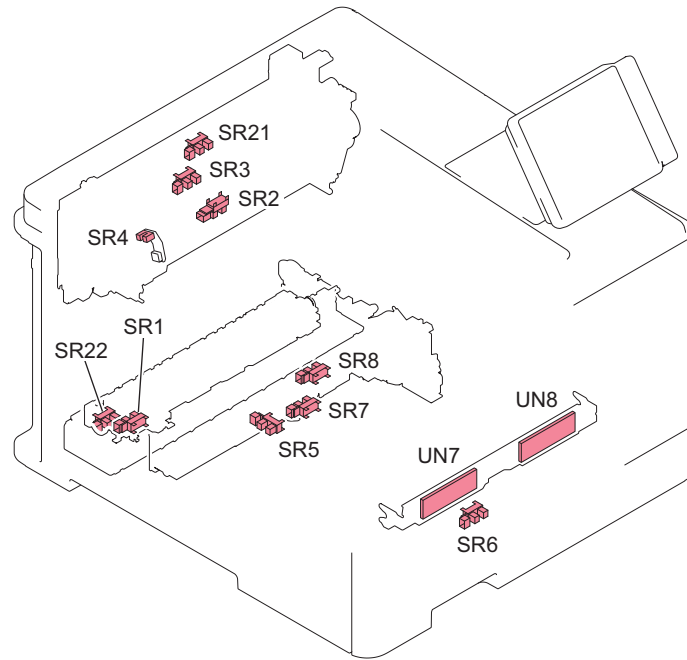

Electric code	Name
SR1	Registration Sensor
SR2	Arch Sensor
SR3	Fixing Delivery Sensor
SR4	Delivery Tray Full Sensor
SR5	Cassette Paper Sensor
SR6	MP Tray Paper Sensor
SR7	Cassette Paper Surface Sensor
SR8	Lifter Sensor
SR21	Duplex Reverse Sensor
SR22	Duplex Re-pickup Sensor
UN7	Density Sensor
UN8	Color Displacement Sensor

## ■ PCB

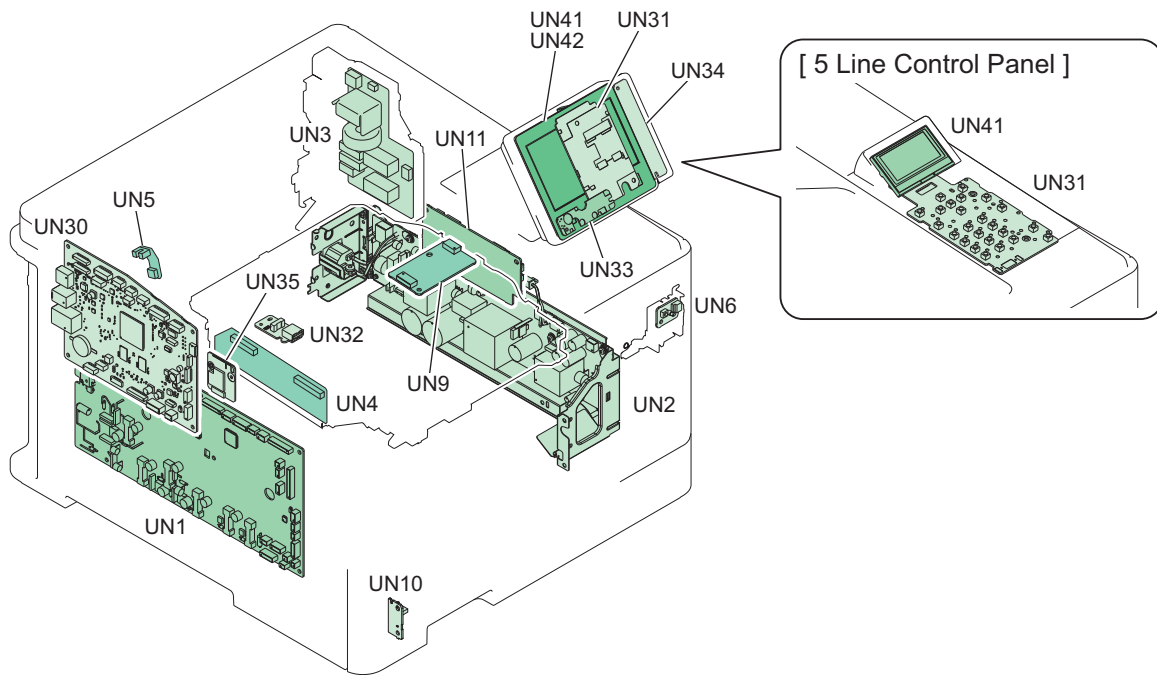

Electric code	Name
UN1	Engine Controller PCB
UN2	Low Voltage Power Supply Unit
UN3	Fixing Power Supply PCB
UN4	Laser Driver PCB
UN5	Delivery Tray Full Sensor PCB
UN6	Laser Driver PCB
UN9	Memory Relay PCB
UN10	Environment Sensor PCB
UN11	Driver PCB
UN30	Main Controller PCB
UN31	Touch Panel Main PCB
UN32	USB PCB
UN33	Panel LED PCB
UN34	Panel NFC PCB
UN35	Wireless LAN PCB
UN41	LCD
UN42	Touch Panel

## External Cover System

### ● Removing the Toner Cartridge

#### ■ Procedure

**CAUTION:**

- Be careful not to damage the Photosensitive Drum.

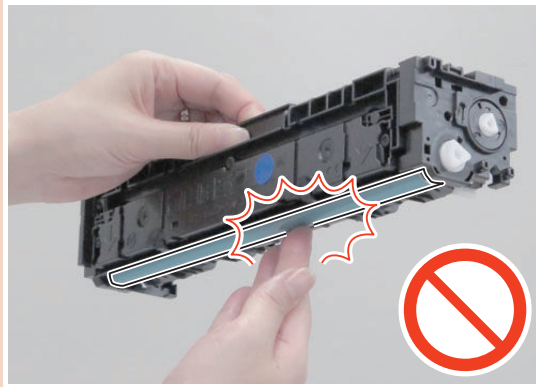

- Be sure to cover the drums with paper to block light.

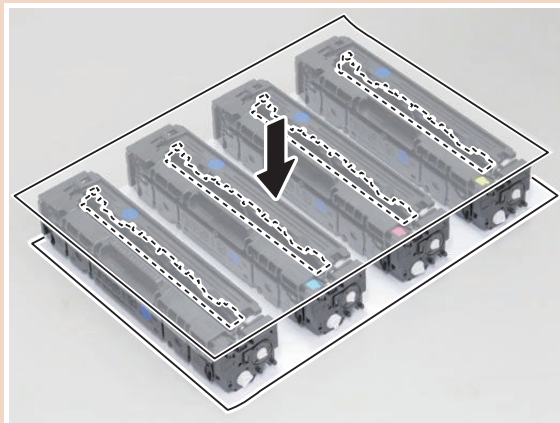

1. Pull out the Cartridge Tray, and remove the Toner Cartridges (Y, M, C, and Bk).

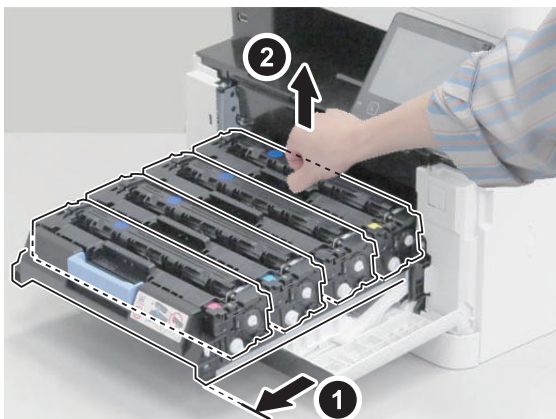

## ● Removing the Left Cover

### ■ Preparation

1. “Removing the Toner Cartridge” on page 75

### ■ Procedure

1. Shift the host machine by approximately 80 mm from the working table to release the claws on the bottom of the Left Cover.

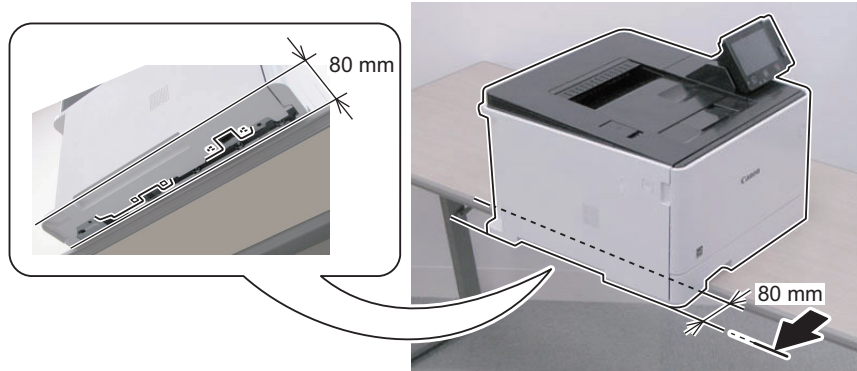

2. Pull out the cassette by approximately 80 mm.

#### ⚠ CAUTION:

Do not completely pull out the cassette, as doing so will disturb the balance of the product and may cause it to fall down.

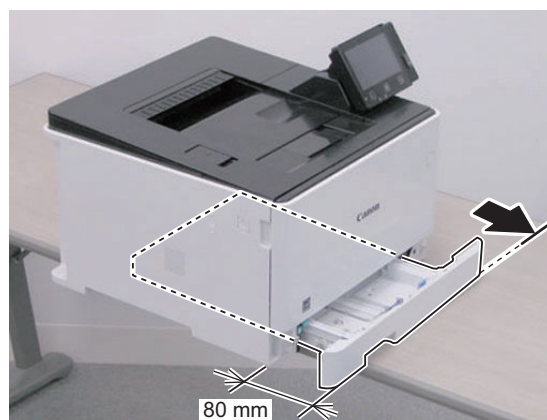

3. Open the Cartridge Cover and the Rear Cover Unit, and remove the screws.

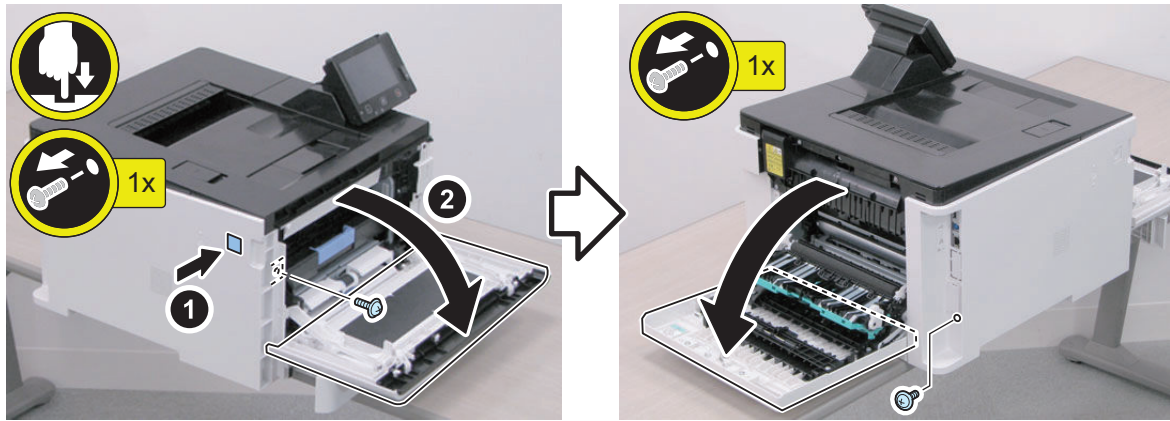

4. Free the bosses and the claw on the front side.

**NOTE:**

- Be sure to remove it while holding the joint because the Cartridge Cover Retainer comes off easily.
- The boss can be freed easily by pulling the Left Cover in the [A] direction and pulling the Cartridge Cover Retainer in the [B] direction.

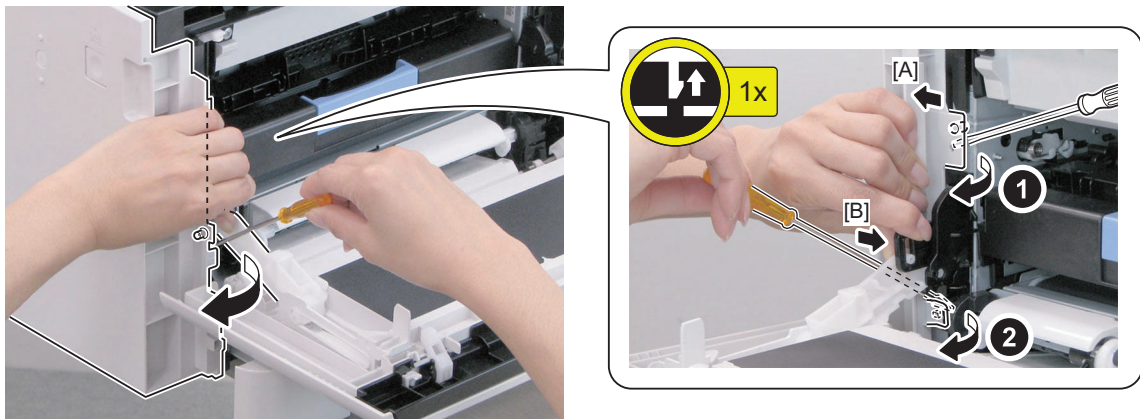

5. Release the claws while opening the Left Cover in the direction of the arrow.



6. Free the bosses and claws, and remove the Left Cover.

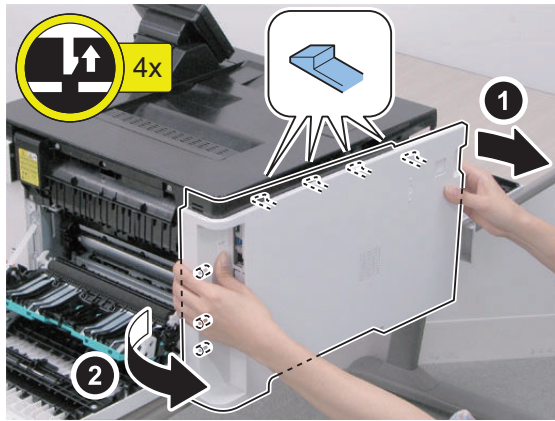

7. Shift the host machine back to the center of the working table to prevent it from falling down.

## ● Removing the Right Cover

### ■ Preparation

1. “Removing the Toner Cartridge” on page 75

### ■ Procedure

1. Shift the host machine by approximately 100 mm from the working table to release the claws on the bottom of the Right Cover.

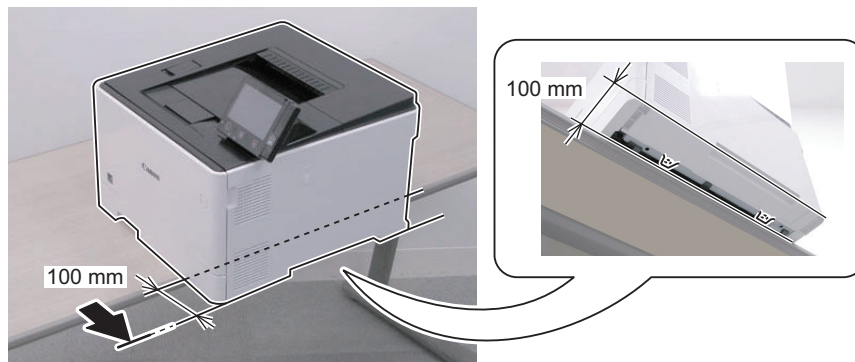

2. Pull out the cassette by approximately 80 mm.

### ⚠ CAUTION:

Do not completely pull out the cassette, as doing so will disturb the balance of the product and may cause it to fall down.



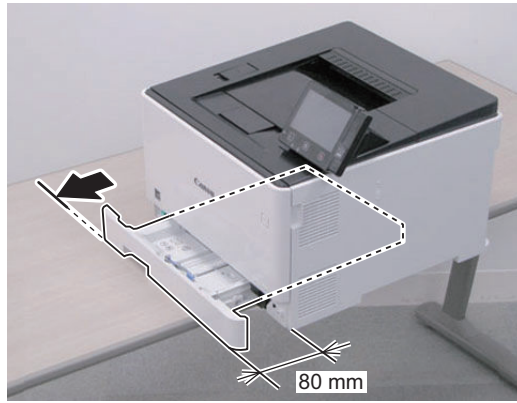

3. Open the Cartridge Cover and the Rear Cover Unit, and remove the screws.

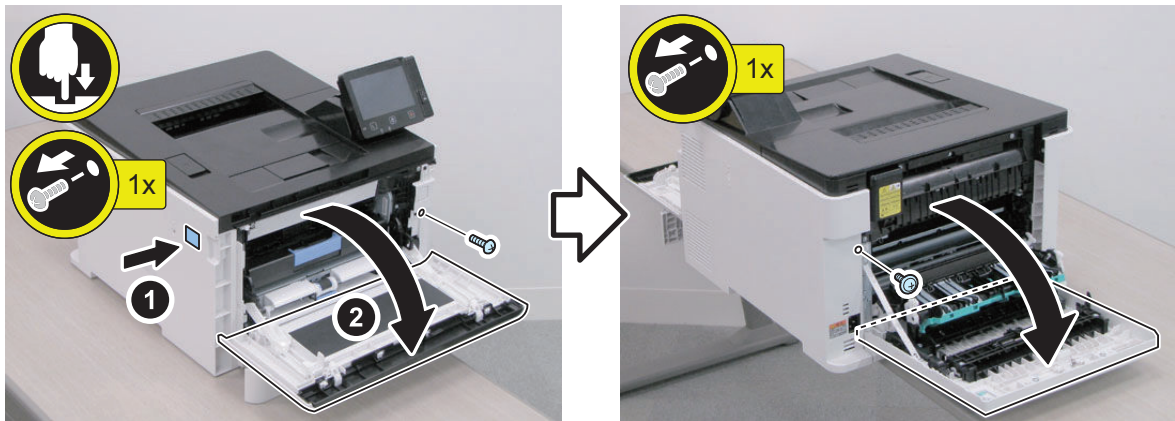

4. Release the claws while opening the Right Cover in the direction of the arrow.

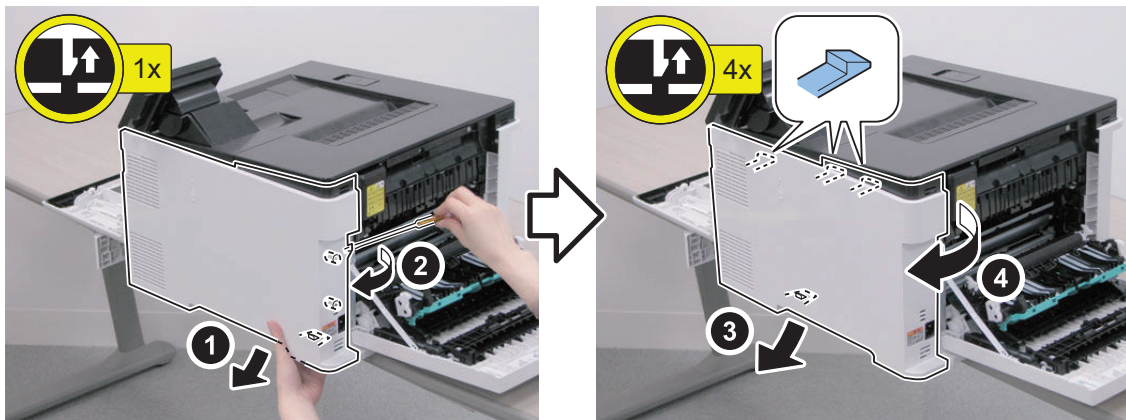

5. Free the bosses and claw, and remove the Right Cover.

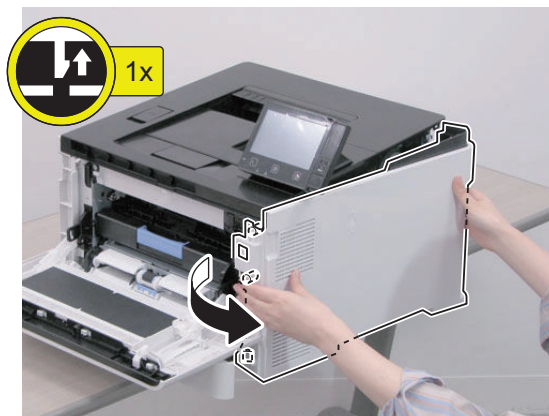

6. Shift the host machine back to the center of the working table to prevent it from falling down.

## ● Removing the Rear Cover Unit

### ■ Preparation

1. “Removing the Toner Cartridge” on page 75
2. “Removing the Left Cover” on page 76
3. “Removing the Right Cover” on page 78

### ■ Procedure

1. Open the Rear Cover Unit, and close the Secondary Transfer Unit.

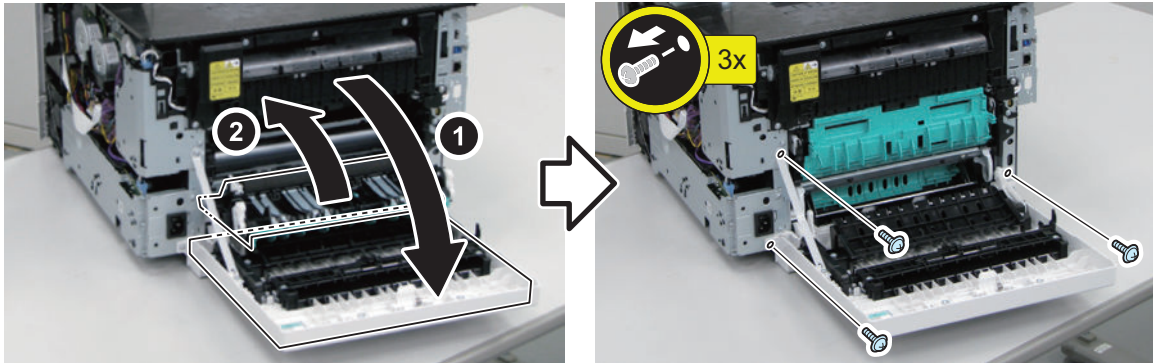

2. Remove the Rear Cover Unit.

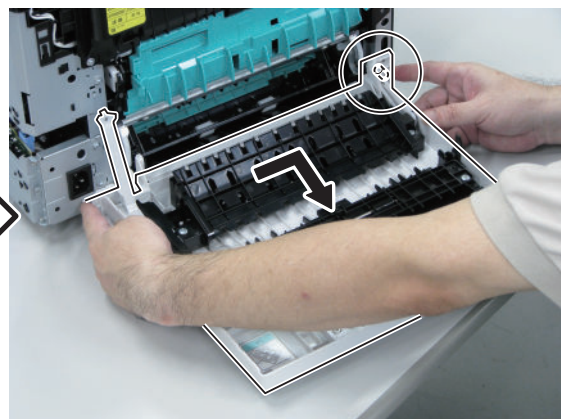
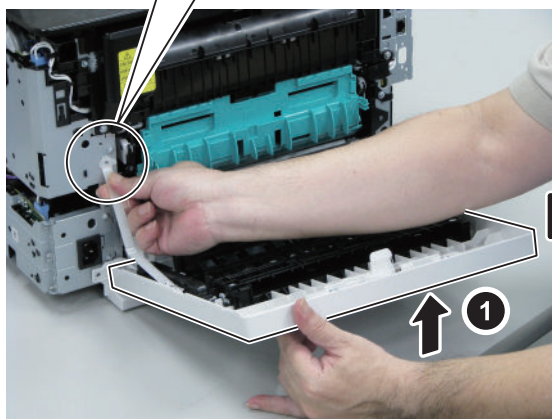
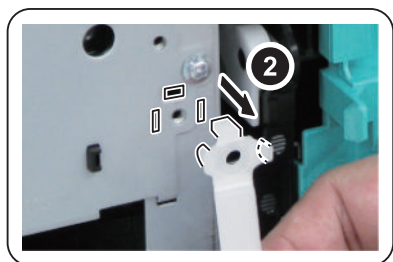

## ● Removing the Cartridge Cover

### ■ Preparation

1. “Removing the Toner Cartridge” on page 75
2. “Removing the Right Cover” on page 78



## ■ Procedure

1. Open the Cartridge Cover.
2. Remove the screw.

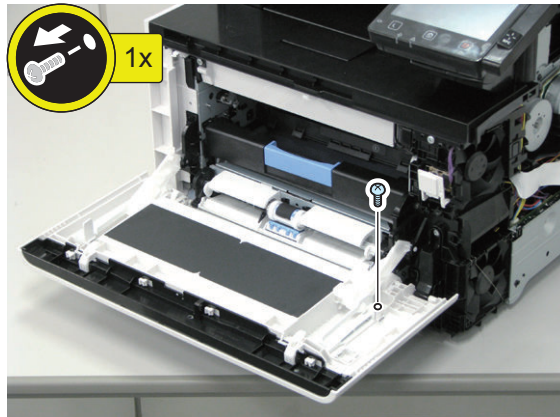

3. Release the Cartridge Cover Retainer on the right side.

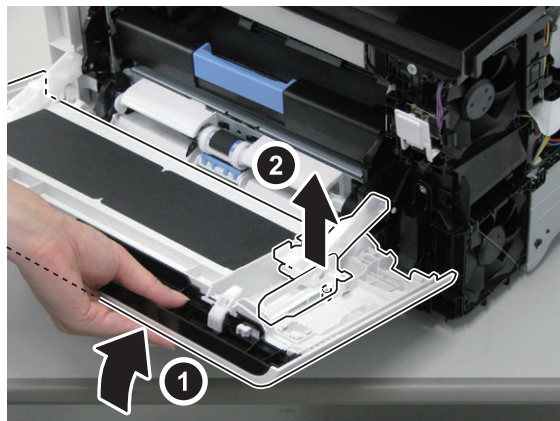

4. Release the Cartridge Cover Retainer on the left side.

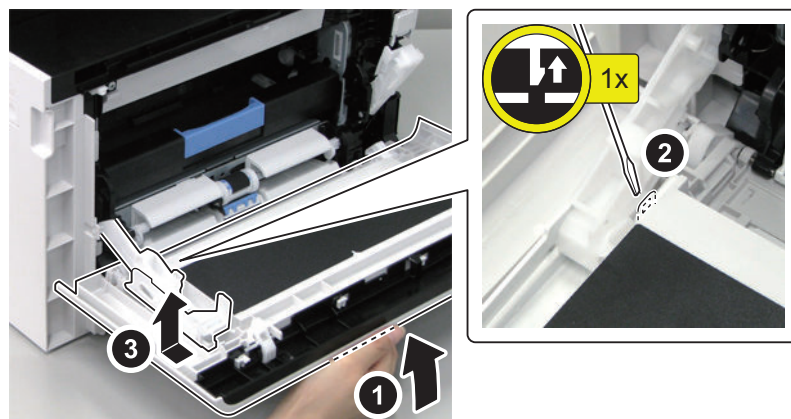

## 5. Remove the Cartridge Cover.

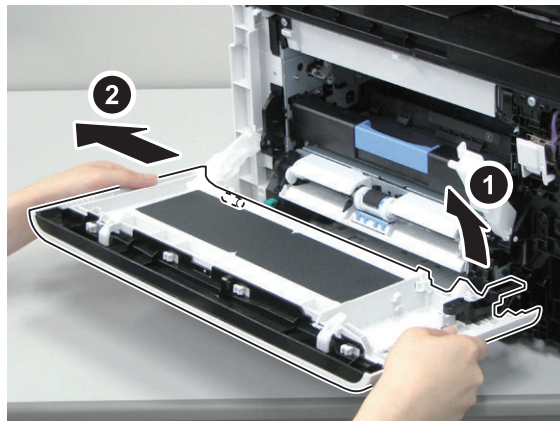
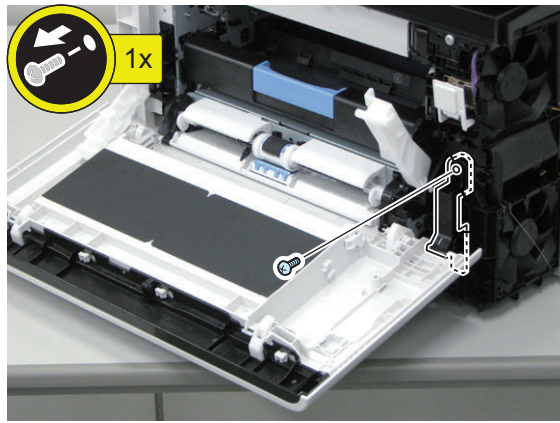

## ● Removing the Cartridge Tray

### ■ Preparation

1. "Removing the Toner Cartridge" on page 75
2. "Removing the Right Cover" on page 78
3. "Removing the Cartridge Cover" on page 80
4. "Removing the Left Cover" on page 76

### ■ Procedure

1. Remove the white Front Door Arm on the left side, and remove the Arm Support Block on the left side.

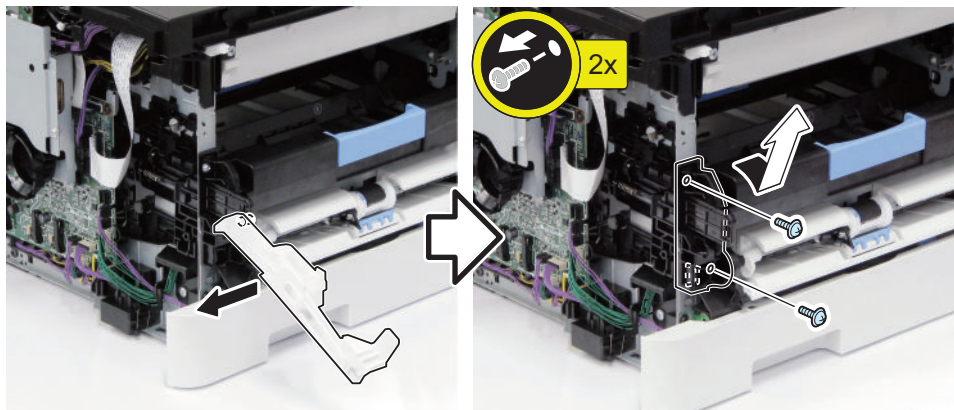

**2. Pull out the Cartridge Tray.**



**3. Remove the guide from the pin while lifting up the left side of the tray. Also remove the guide from the pin on the right side. Since the Cartridge Tray is still in the groove of the white guide on the right side, turn the tray counterclockwise to remove it from the white guide.**

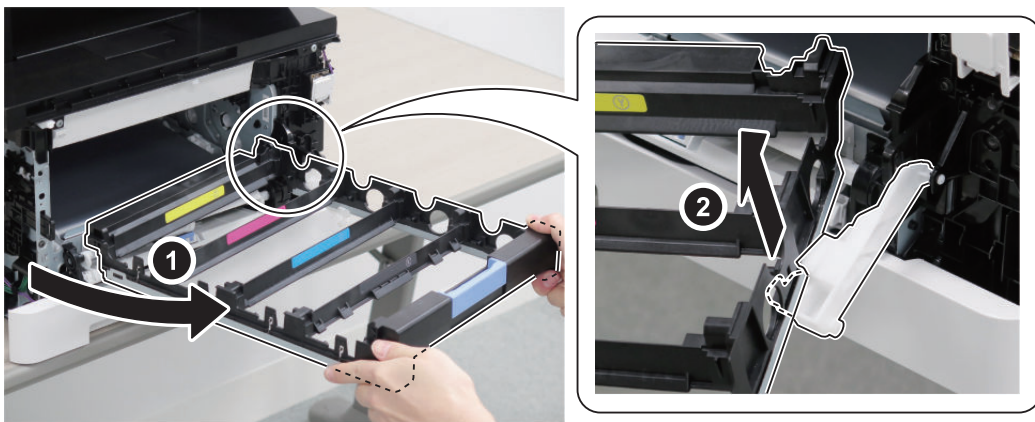

**NOTE:**

When installing the Cartridge Tray, first make the pin on the right side enter the groove on the tray. Next, insert the tray under the black pin on the left side, and insert it in all the way along the tray guide on the bottom.

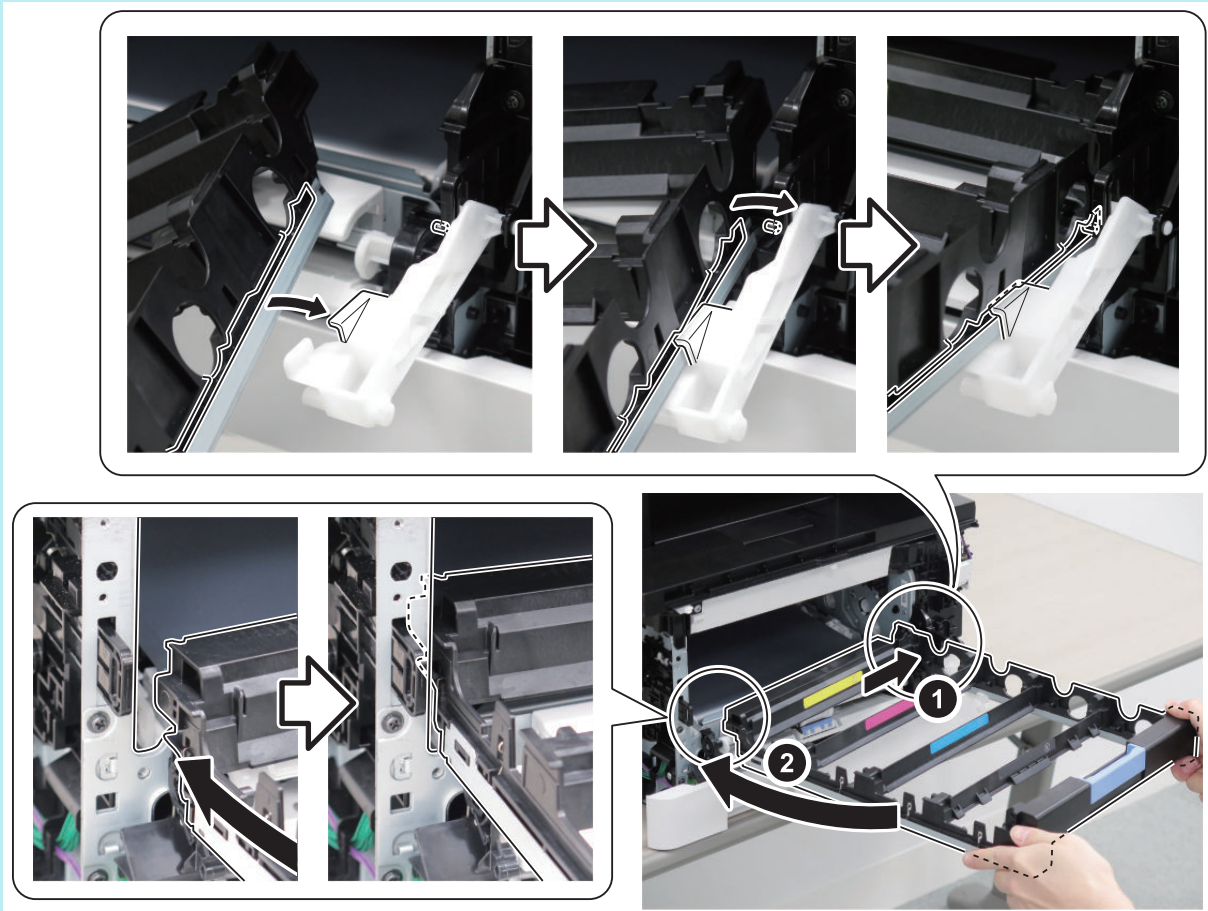

## ● Removing the Control Panel Lower Cover

### ■ Preparation

1. “Removing the Toner Cartridge” on page 75
2. “Removing the Right Cover” on page 78
3. “Removing the Control Panel Unit” on page 92

### ■ Procedure

1. Remove the Control Panel Lower Cover.

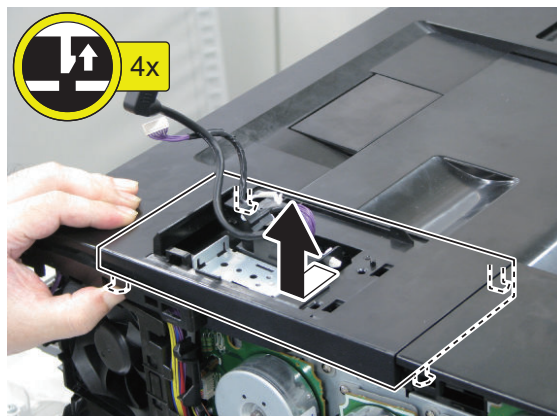

## ● Removing the Upper Cover Unit

### ■ Preparation

1. “Removing the Toner Cartridge” on page 75
2. “Removing the Left Cover” on page 76
3. “Removing the Right Cover” on page 78
4. “Removing the Control Panel Unit” on page 92
5. “Removing the Control Panel Lower Cover” on page 84

### ■ Procedure

1. Remove the screw.

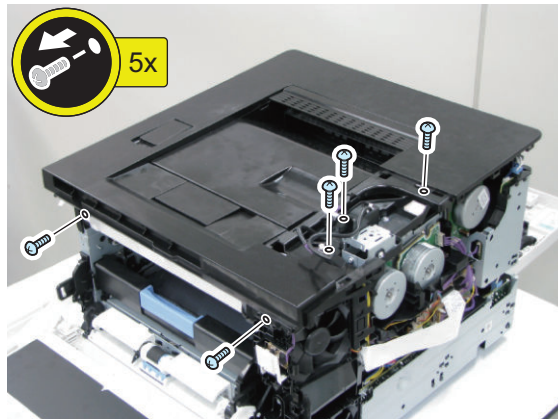

2. Remove the screws.

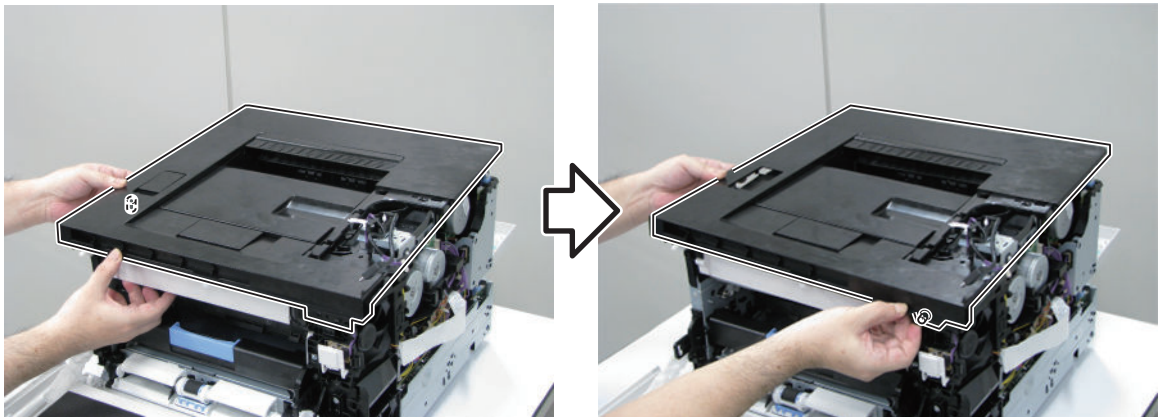

**3. Remove the Upper Right Front Cover.**

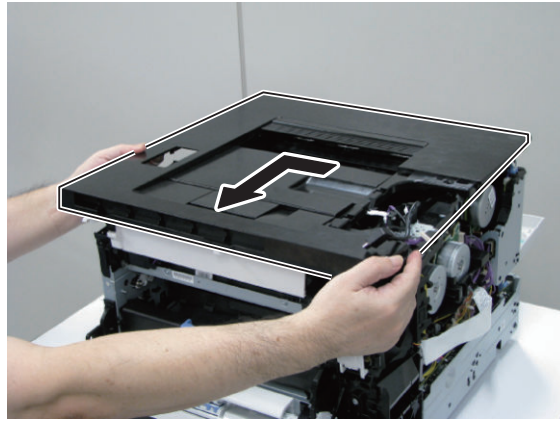

## Controller System

### ● Removing the Controller Cover

#### ■ Preparation

1. “Removing the Toner Cartridge” on page 75
2. “Removing the Left Cover” on page 76

#### ■ Procedure

1. Remove the Controller Cover.

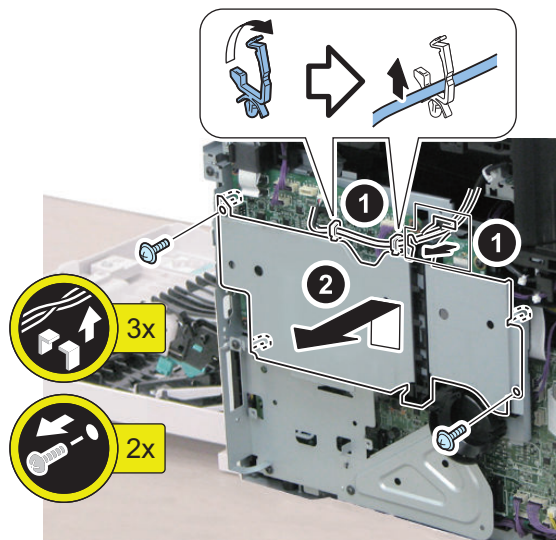

### ● Removing the Wireless LAN PCB (Wi-Fi model only)

#### ■ Preparation

1. “Removing the Toner Cartridge” on page 75
2. “Removing the Left Cover” on page 76
3. “Removing the Controller Cover ” on page 87

#### ■ Procedure

1. Remove the Wireless LAN PCB.

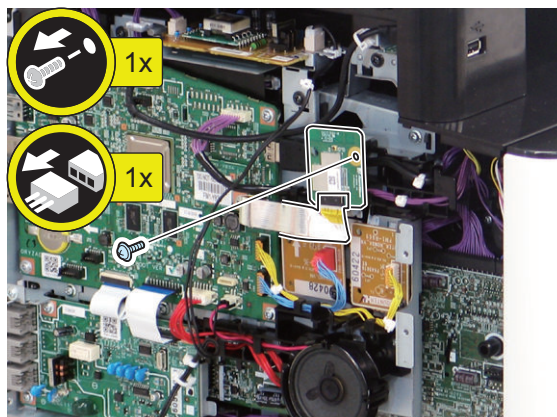

## ● Removing the Wireless LAN Support Plate (Wi-Fi model only)

### ■ Preparation

1. “Removing the Toner Cartridge” on page 75
2. “Removing the Left Cover” on page 76
3. “Removing the Controller Cover ” on page 87
4. “Removing the Wireless LAN PCB (Wi-Fi model only)” on page 87

### ■ Procedure

1. Remove the Wireless LAN Support Plate.

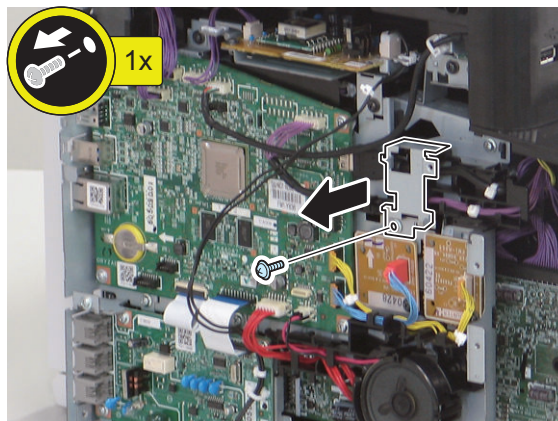

## ● Removing the Main Controller PCB

### ■ Preparation

1. “Removing the Toner Cartridge” on page 75
2. “Removing the Left Cover” on page 76
3. “Removing the Controller Cover ” on page 87

### ■ Procedure

1. Disconnect all connectors from the Main Controller PCB and then remove the PCB.

<LBP654Cdw>

<LBP654Cx>

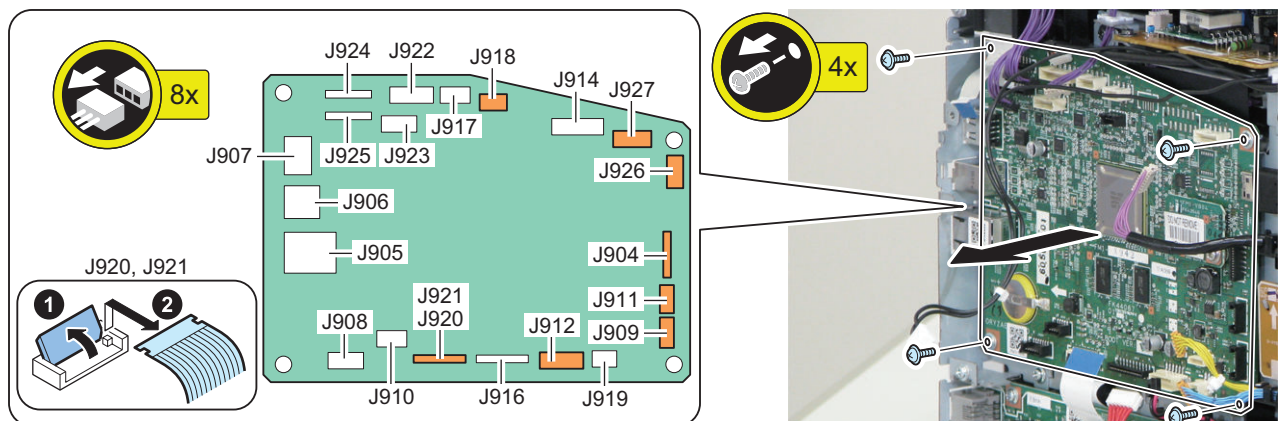

2. Actions after replacement: “After Replacing the Main Controller PCB” on page 137



## ● Removing the Main Controller Support Plate

### ■ Preparation

1. “Removing the Toner Cartridge” on page 75
2. “Removing the Left Cover” on page 76
3. “Removing the Controller Cover ” on page 87
4. “Removing the Main Controller PCB” on page 88
5. “Removing the Wireless LAN Support Plate (Wi-Fi model only)” on page 88

### ■ Procedure

1. Remove the Main Controller Support Plate.

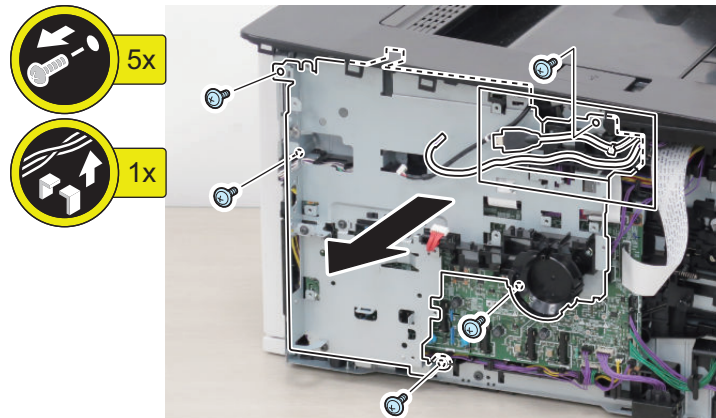

## ● Removing the Engine Controller PCB

### ■ Preparation

1. “Removing the Toner Cartridge” on page 75
2. “Removing the Left Cover” on page 76
3. “Removing the Controller Cover ” on page 87
4. “Removing the Main Controller PCB” on page 88
5. “Removing the Wireless LAN Support Plate (Wi-Fi model only)” on page 88
6. “Removing the Main Controller Support Plate” on page 89

## ■ Procedure

### 1. Remove the Engine Controller PCB.

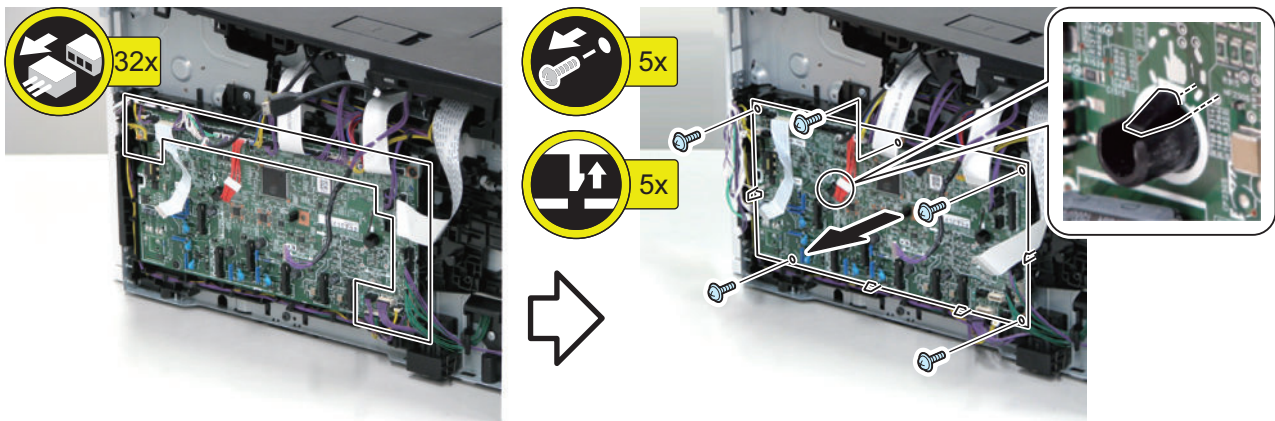

#### CAUTION:

When installing it, be sure that the flag of the microswitch is in the correct position.

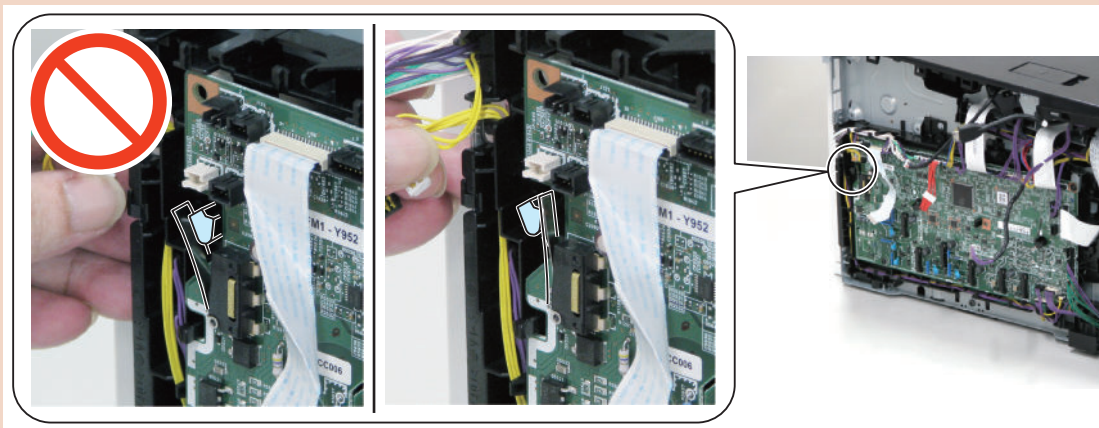

### 2. Actions after replacement: [“After Replacing the Engine Controller PCB” on page 136](#)

## ● Removing the Low Voltage Power Supply Unit

### ■ Preparation

1. [“Removing the Toner Cartridge” on page 75](#)
2. [“Removing the Right Cover” on page 78](#)

## ■ Procedure

### 1. Remove the Power Supply Fan Unit.

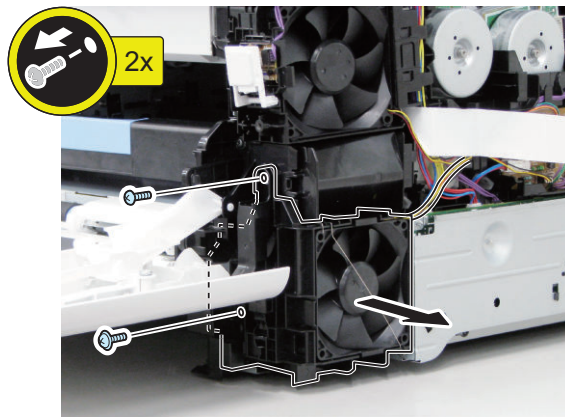

### 2. Remove the Low Voltage Power Supply Unit.

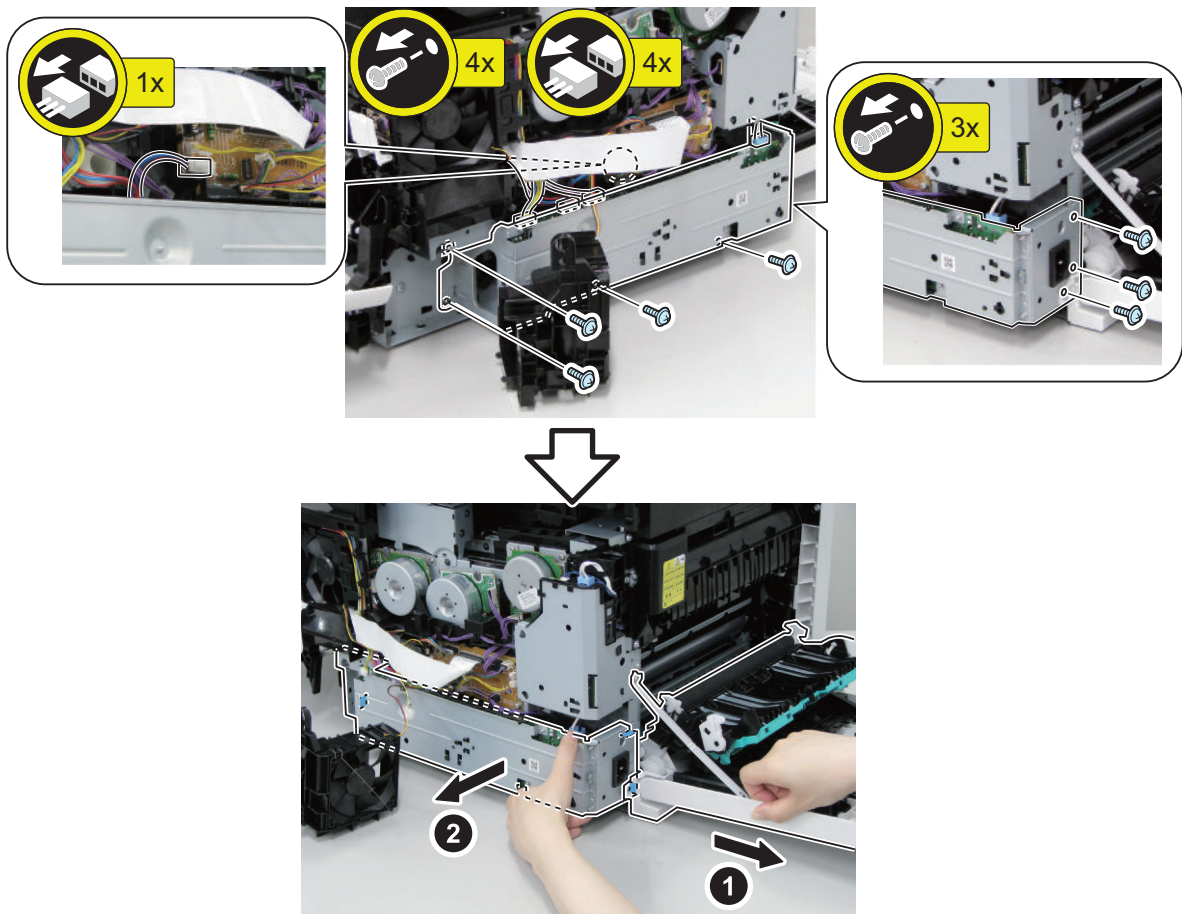

## ● Removing the Control Panel Unit

### ■ Procedure

1. Remove the Panel Arm Cover (Middle).



2. Remove the Panel Arm Left Cover.

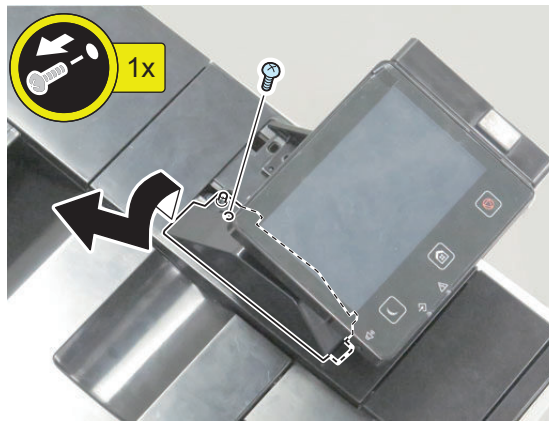

3. Remove the Panel Arm Right Cover.

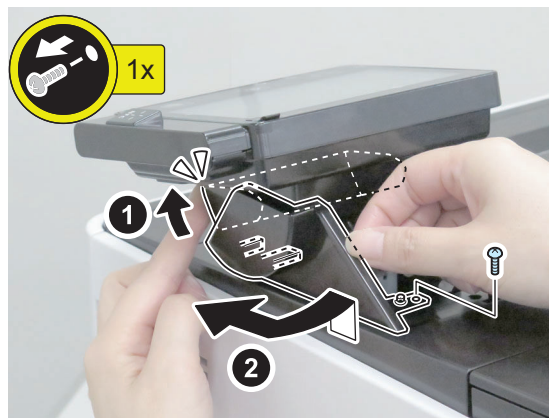

4. Remove the Panel Rear Upper Cover.



5. Remove the Panel Front Lower Cover.

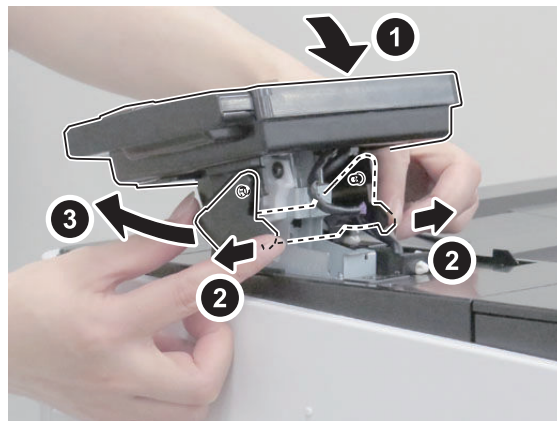

6. Remove the Control Panel.

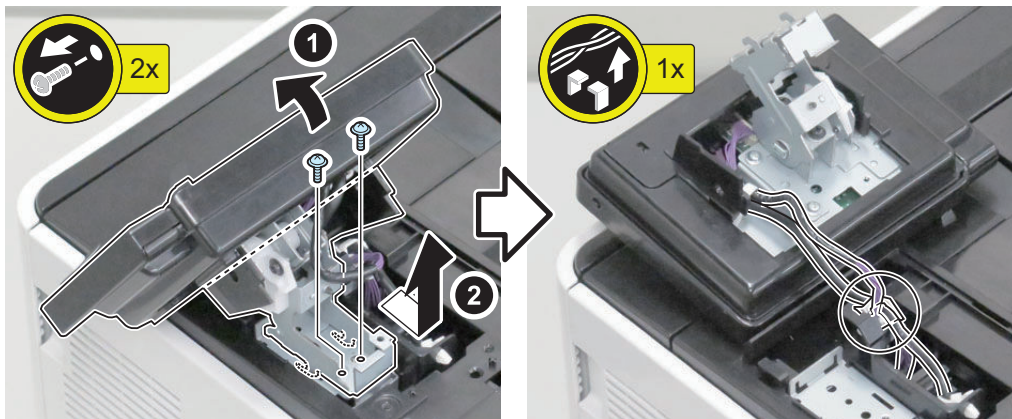

7. Remove the Panel Rear Lower Cover. Disconnect the connector and HDMI Cable, and free the harness from the Wire Saddle.

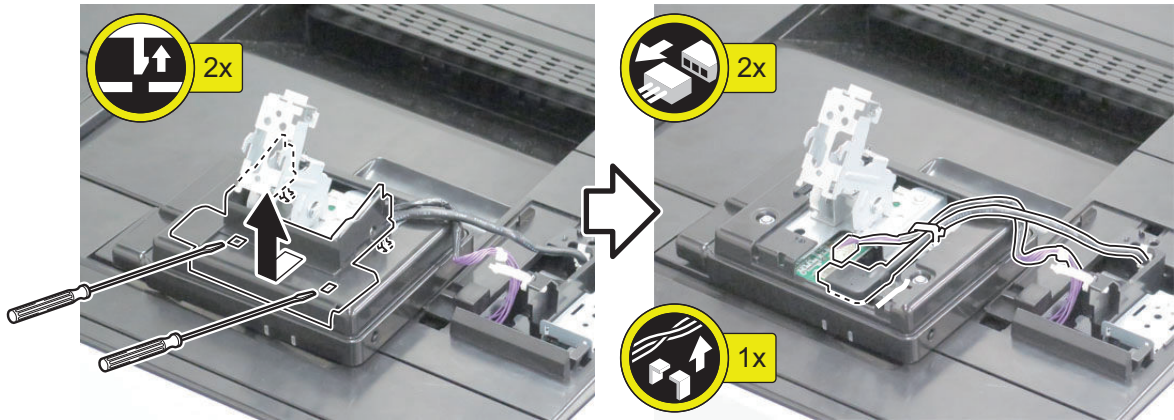

8. Remove the Panel Rear Cover.

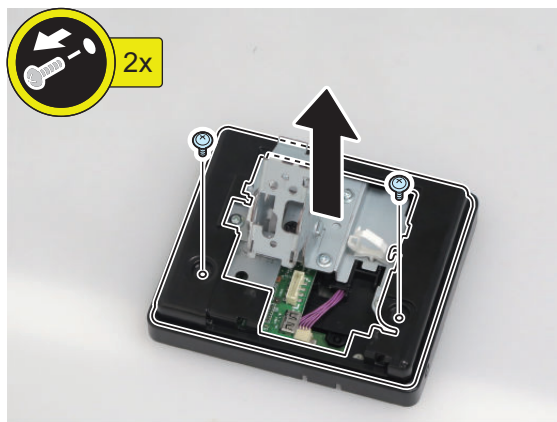

9. Remove the Hinge Unit.

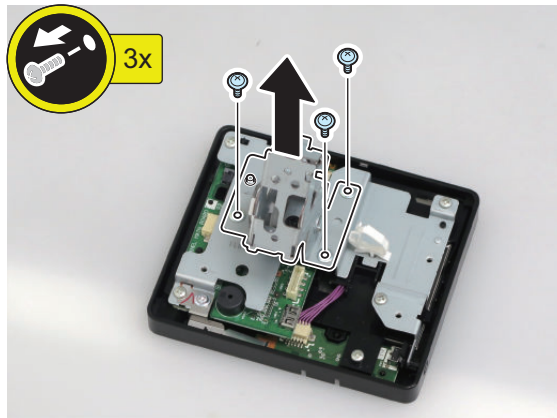

10. Actions after replacement: “After Replacing the Control Panel” on page 136

## ● Removing the USB PCB

### ■ Preparation

1. “Removing the Toner Cartridge” on page 75
2. “Removing the Left Cover” on page 76
3. “Removing the Right Cover” on page 78
4. “Removing the Control Panel Unit” on page 92

- 5. "Removing the Control Panel Lower Cover" on page 84
- 6. "Removing the Upper Cover Unit " on page 85

## ■ Procedure

- 1. Remove the USB Cover.

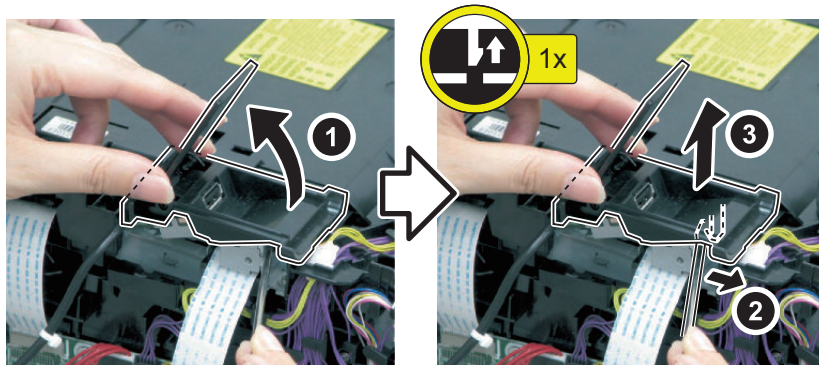

- 2. Remove the USB PCB Unit.

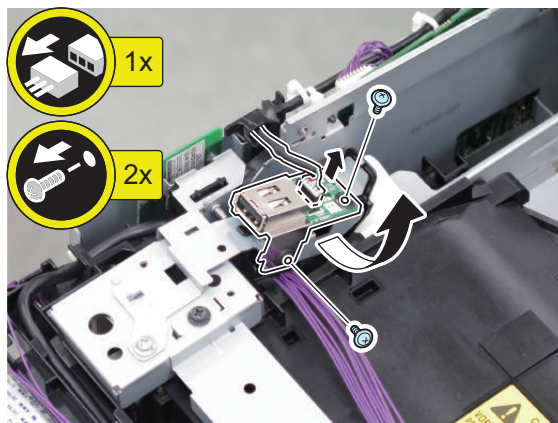

- 3. Remove the USB Connector Cover.

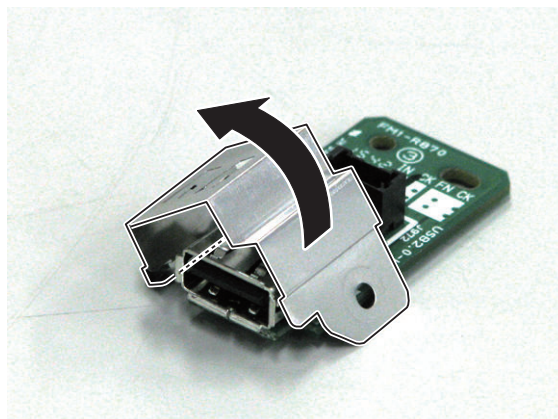

## ● Removing the Cartridge Fan

### ■ Preparation

- 1. "Removing the Toner Cartridge" on page 75
- 2. "Removing the Right Cover" on page 78

## ■ Procedure

### 1. Remove the Cartridge Fan.

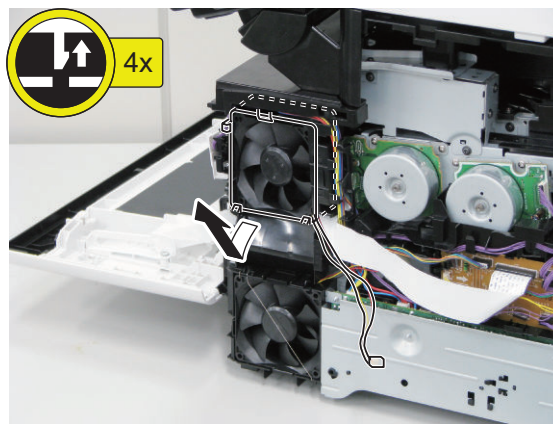
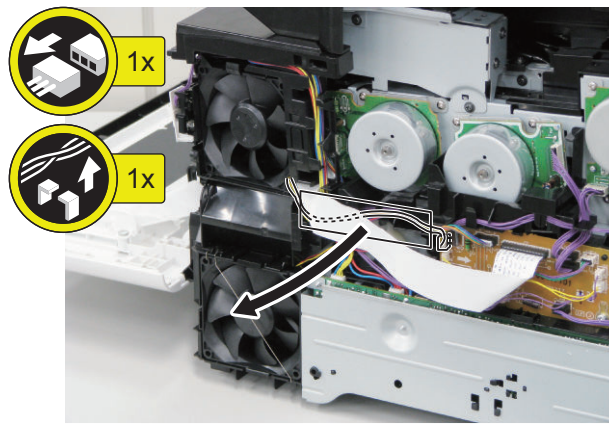

## ● Removing the Power Supply Fan

### ■ Preparation

1. [“Removing the Toner Cartridge” on page 75](#)
2. [“Removing the Right Cover” on page 78](#)



## ■ Procedure

### 1. Remove the Power Supply Fan.

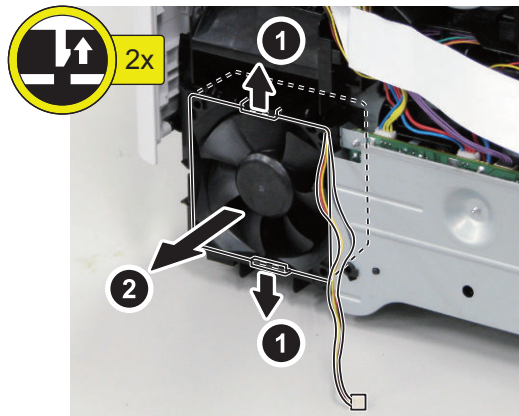
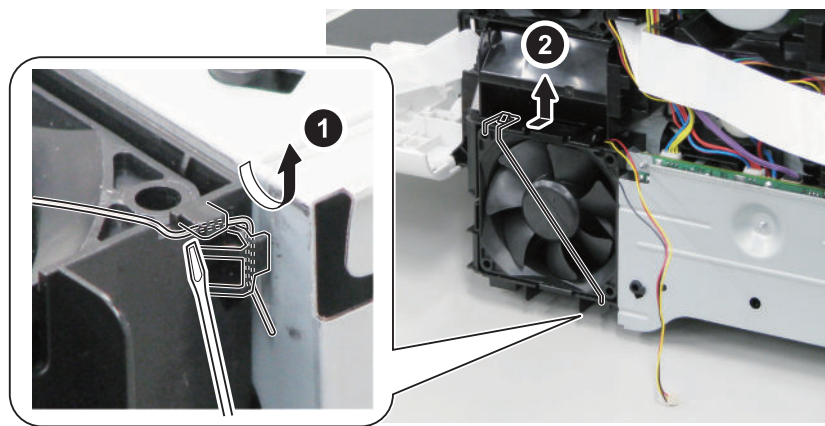
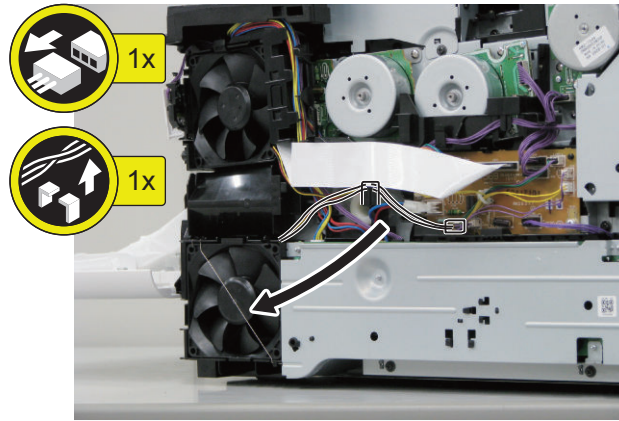

## ● Removing the Driver PCB

### ■ Preparation

1. "Removing the Toner Cartridge" on page 75
2. "Removing the Right Cover" on page 78

## ■ Procedure

1. Remove the Driver PCB.

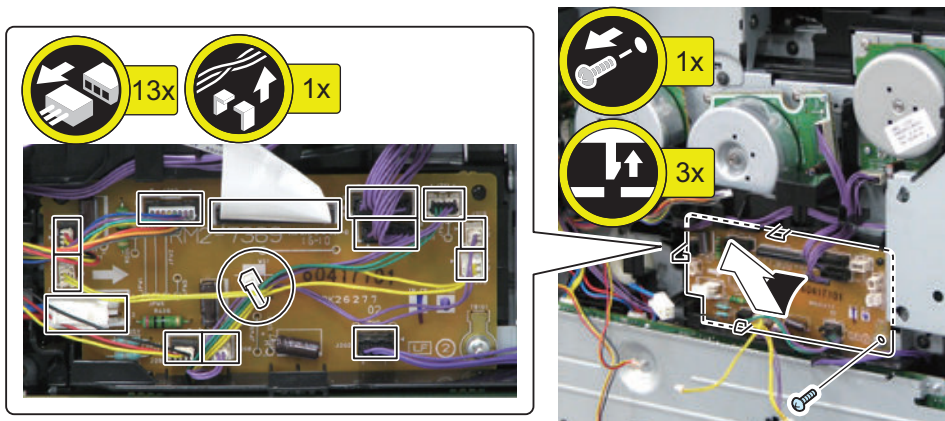

## ● Removing the Power Switch Unit

### ■ Preparation

1. "Removing the Toner Cartridge" on page 75
2. "Removing the Right Cover" on page 78

### ■ Procedure

1. Remove the Power Switch Unit.

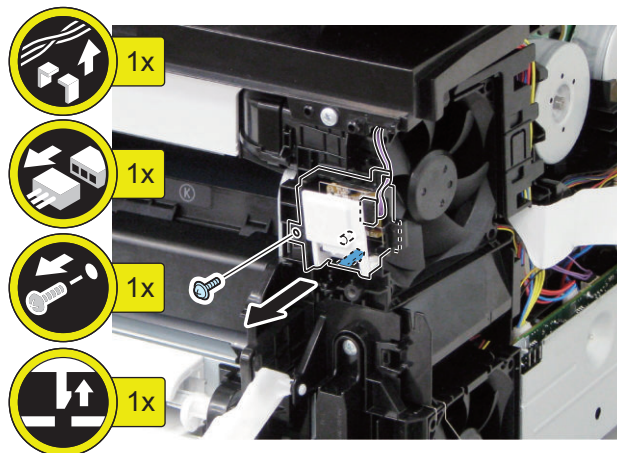

## ● Removing the Environment Sensor

### ■ Preparation

1. "Removing the Toner Cartridge" on page 75
2. "Removing the Left Cover" on page 76

## ■ Procedure

### 1. Remove the Environment Sensor.

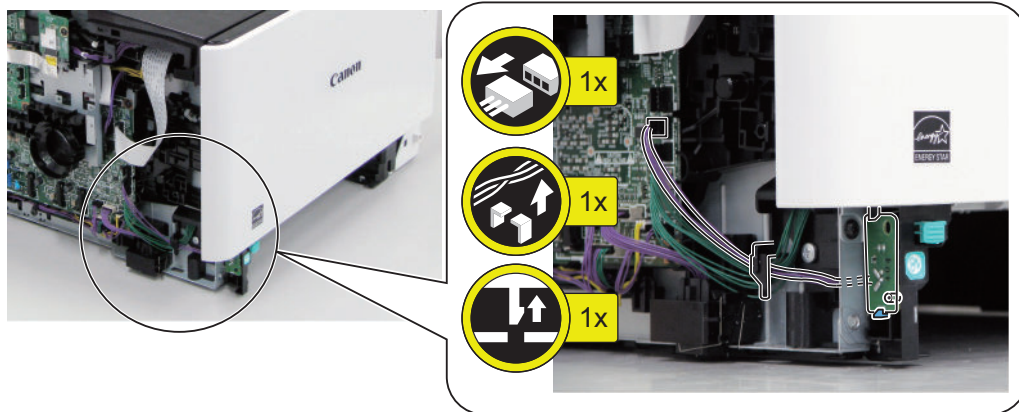

### 2. Remove the Harness.

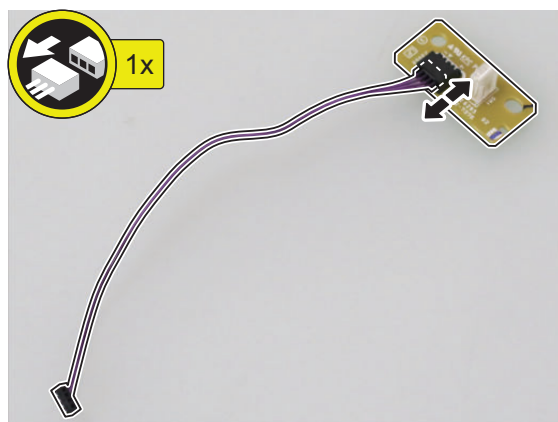

## ● Removing the Memory Relay PCB

### ■ Preparation

1. "Removing the Toner Cartridge" on page 75
2. "Removing the Right Cover" on page 78
3. "Removing the Left Cover" on page 76
4. "Removing the Control Panel Unit" on page 92
5. "Removing the Control Panel Lower Cover" on page 84
6. "Removing the Upper Cover Unit" on page 85

## ■ Procedure

### 1. Remove the Memory Relay PCB.

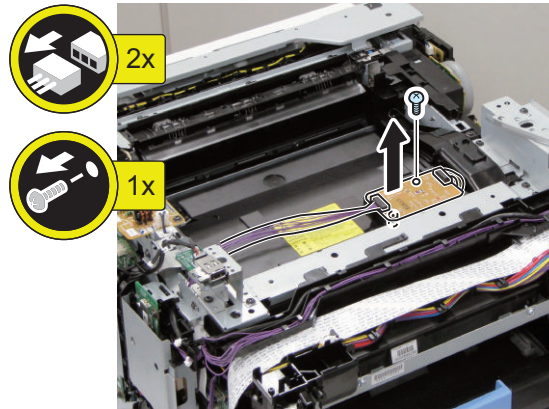

# Laser Exposure System

## ● Removing the Laser Scanner Unit

### ■ Preparation

1. “Removing the Toner Cartridge” on page 75
2. “Removing the Left Cover” on page 76
3. “Removing the Right Cover” on page 78
4. “Removing the Control Panel Unit” on page 92
5. “Removing the Control Panel Lower Cover” on page 84
6. “Removing the Upper Cover Unit ” on page 85
7. “Removing the Controller Cover ” on page 87
8. “Removing the Main Controller PCB” on page 88
9. “Removing the Wireless LAN Support Plate (Wi-Fi model only)” on page 88
10. “Removing the Main Controller Support Plate” on page 89
11. “Removing the USB PCB” on page 94

### ■ Procedure

1. Remove the Harness Guide.

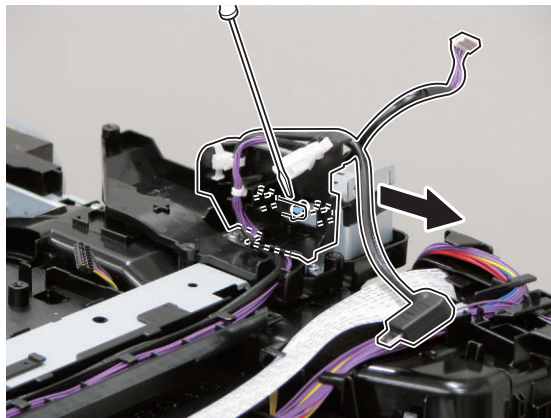

2. Remove the Touch Panel Mounting Base.

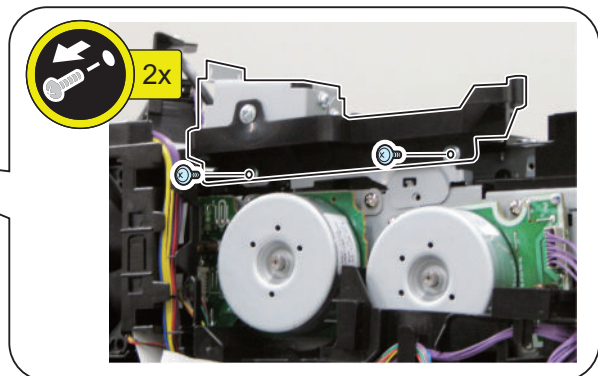
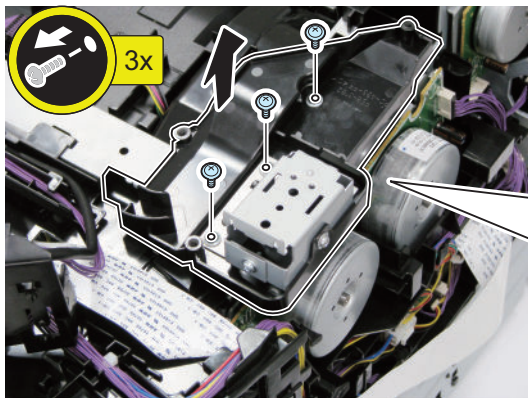

3. Remove the USB Mounting Base.

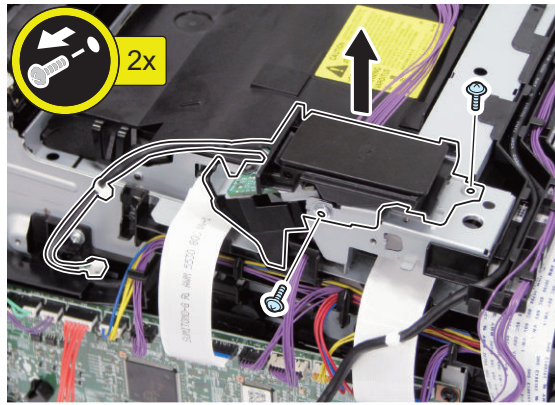

4. Remove the Laser Unit Upper Plate.

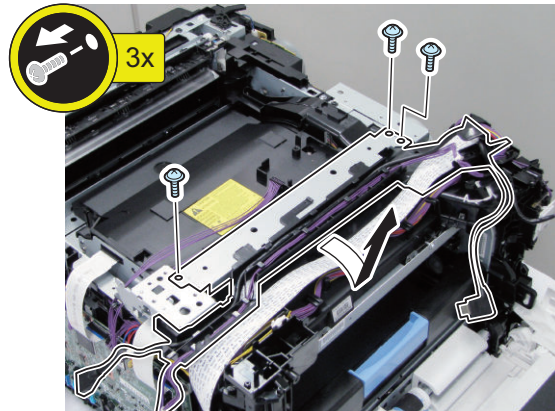

5. Remove the plate.

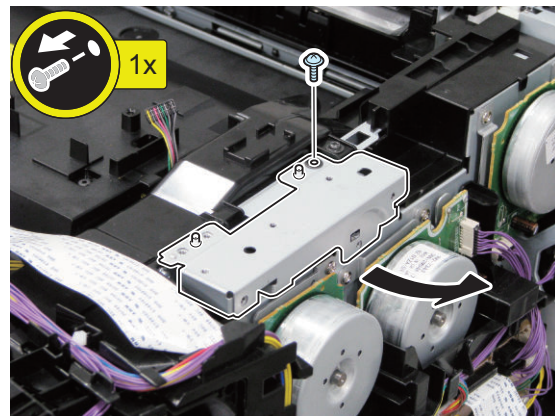

6. Remove the USB Mounting Plate.

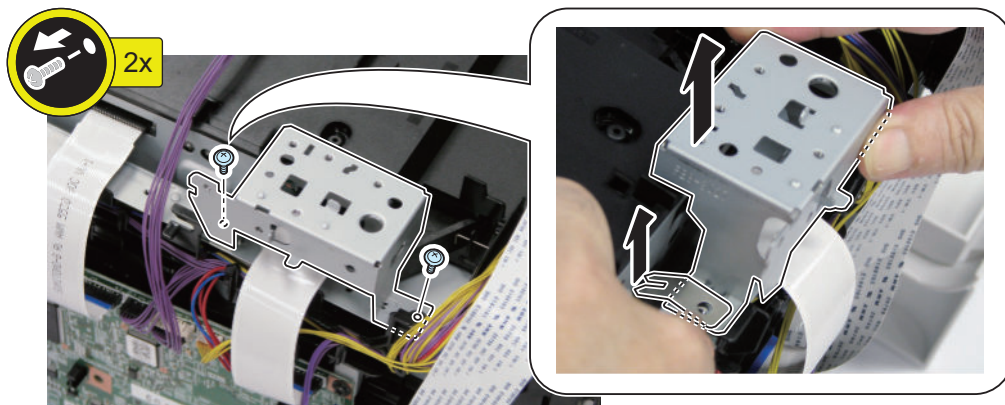

7. Disconnect the connector.

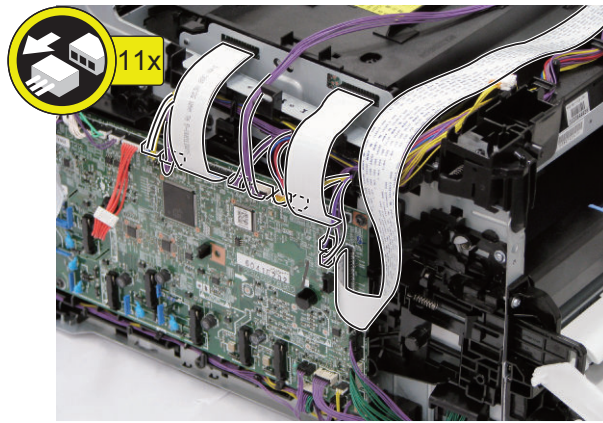

8. Remove the Memory Relay PCB.

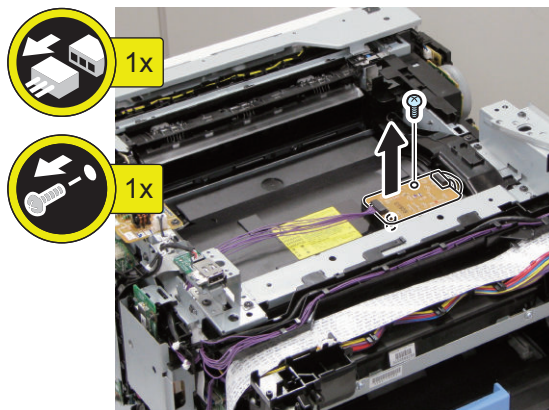

9. Free the harness.

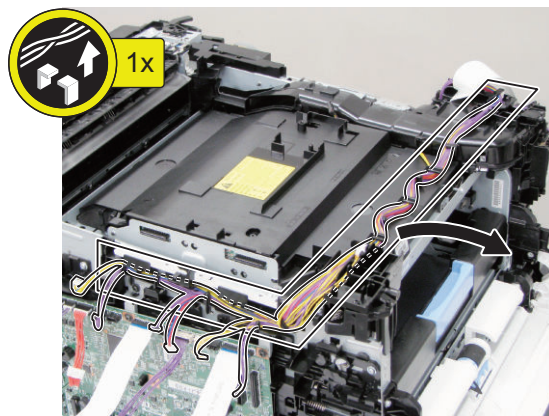

10. Remove the Laser Shutter Open/Close Detection Unit.

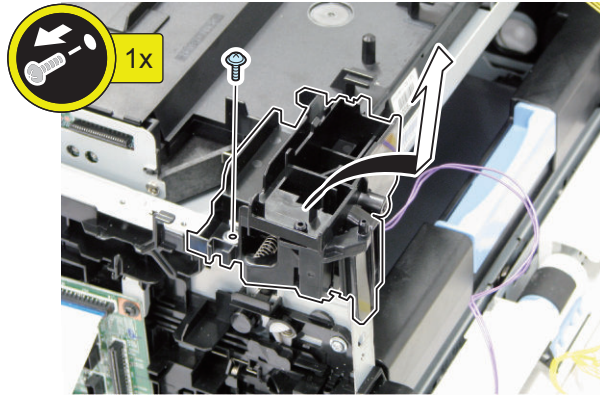

**NOTE:**

When installing it, be sure that the L-shaped wire is placed on the Shutter Lever of the Laser Unit.

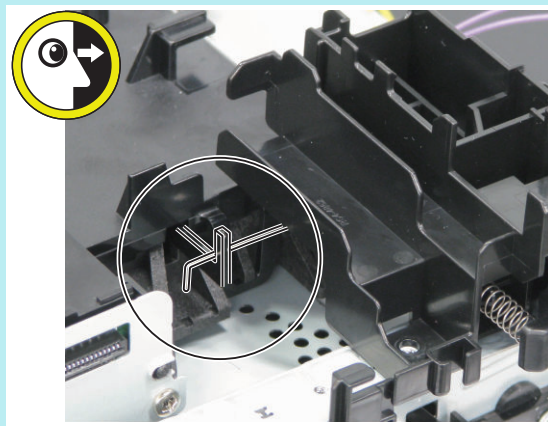

11. Remove the Gear Cover and then remove the Cover under the Gear Cover.

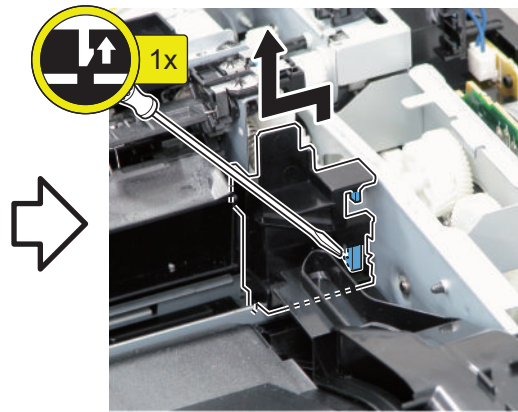
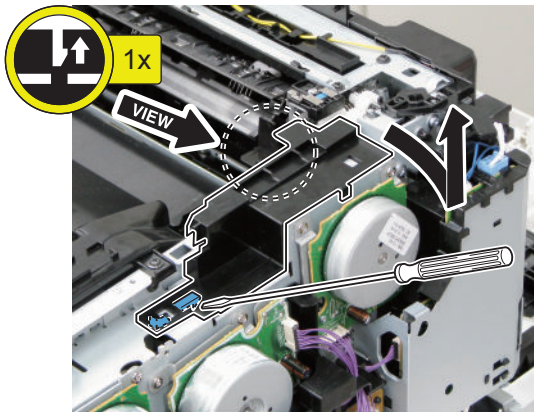



12. Remove the Duct Cover.

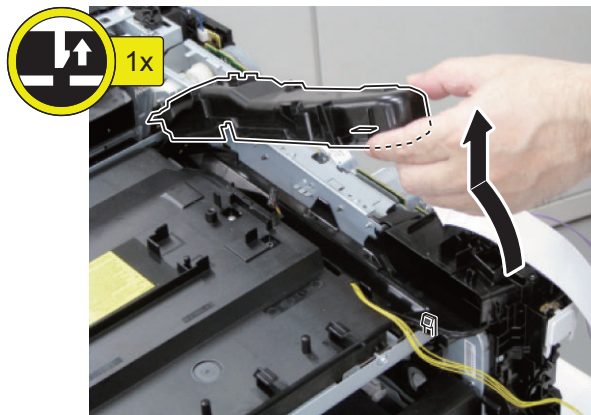
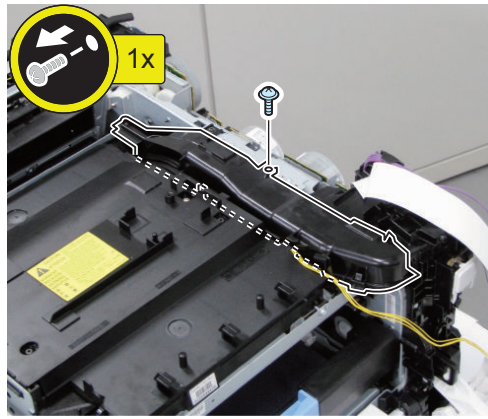

13. Loosen the screws, and remove the Laser Scanner Unit Fixation Pins.

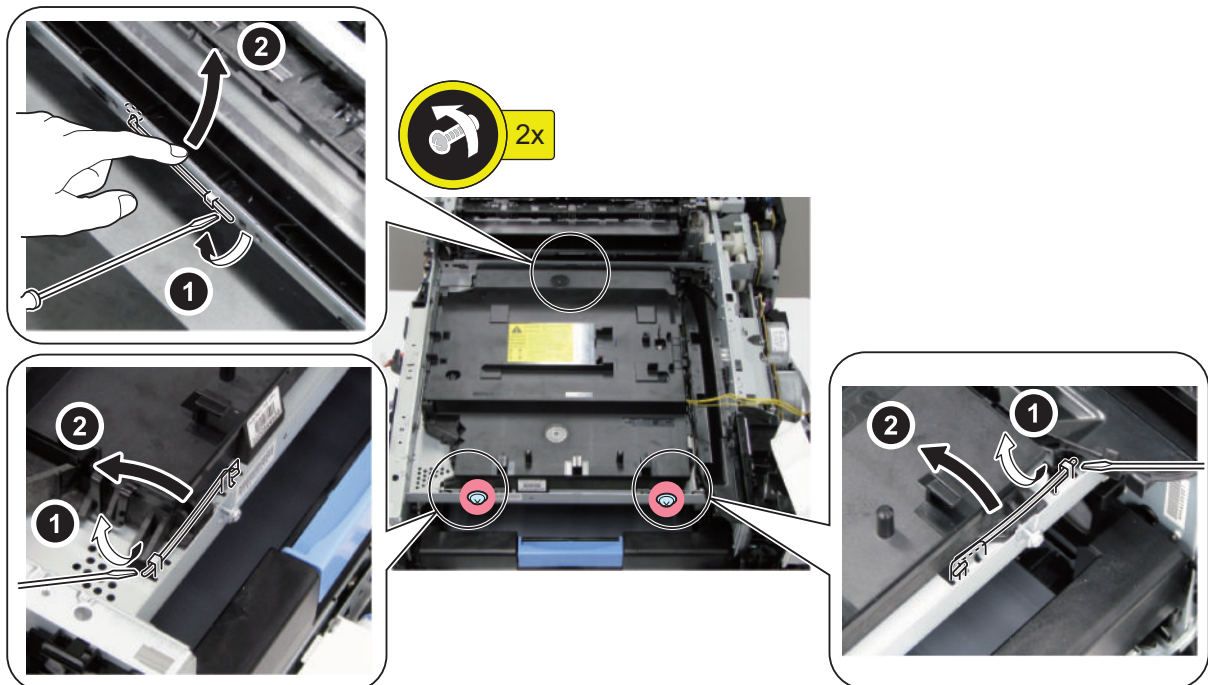

## 14. Remove the Laser Scanner Unit.

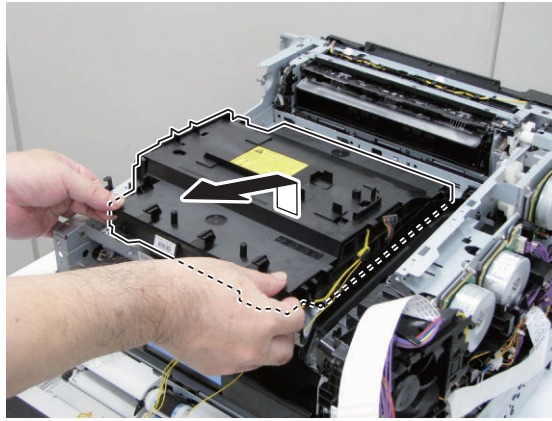
**CAUTION:**

## Points to Note at Installation

- Insert the bosses into the positioning holes, and check that the Laser Unit is correctly positioned.
- Be sure that the Laser Unit is properly pushed down and secured with the 3 Fixation Pins. Also be sure that the Fixation Pins are securely fitted and will not come off.

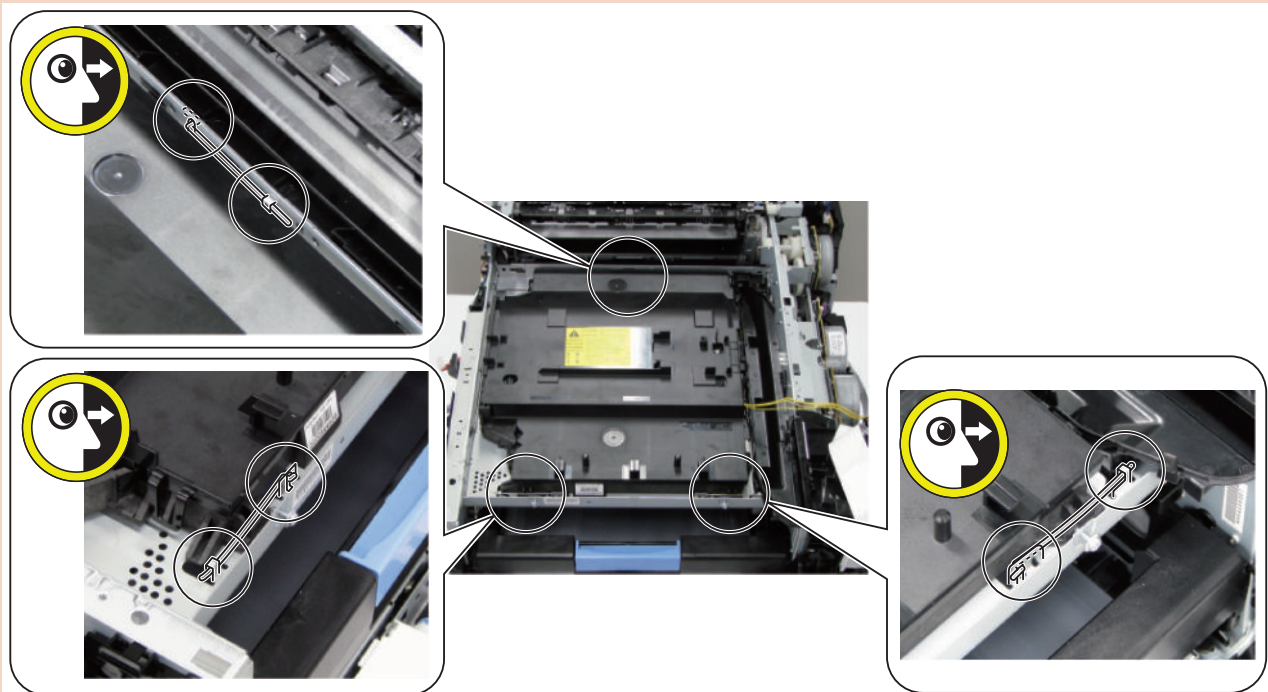
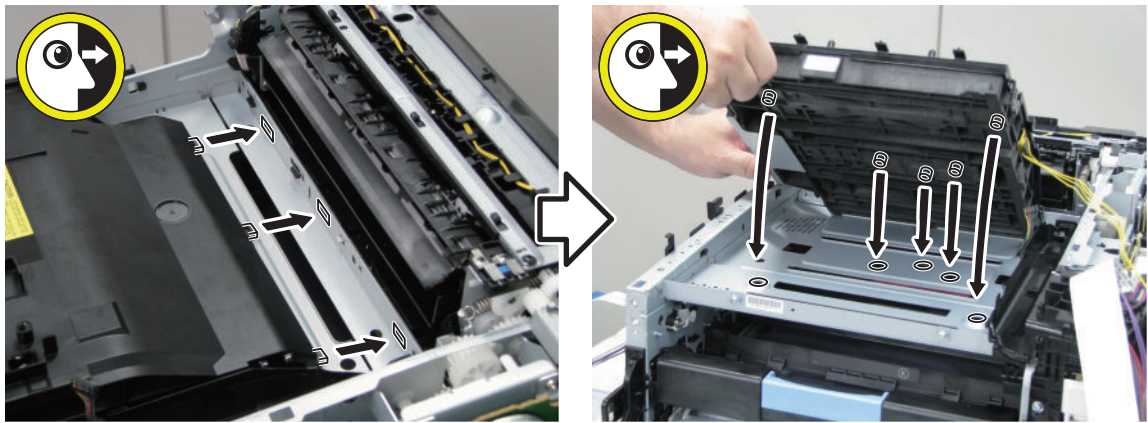

## Image Formation System

### ● Removing the Secondary Transfer Roller

#### ■ Preparation

1. "Removing the Toner Cartridge" on page 75

#### ■ Procedure

##### CAUTION:

Do not touch the surface of the Secondary Transfer Roller.

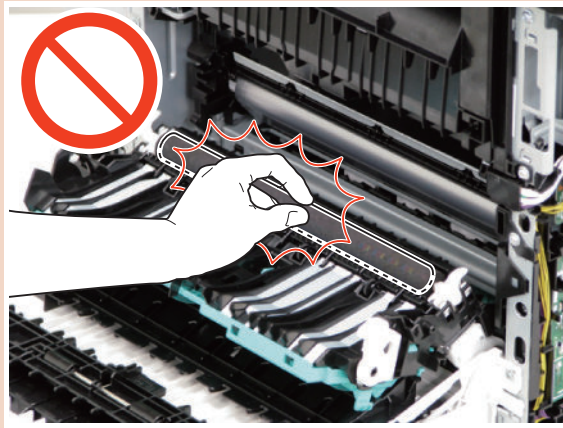

1. Open the Rear Cover Unit and the Secondary Transfer Feed Unit.

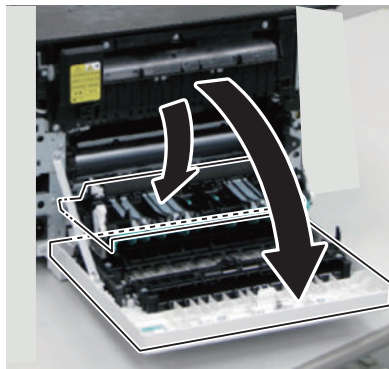

2. Remove the Secondary Transfer Roller.

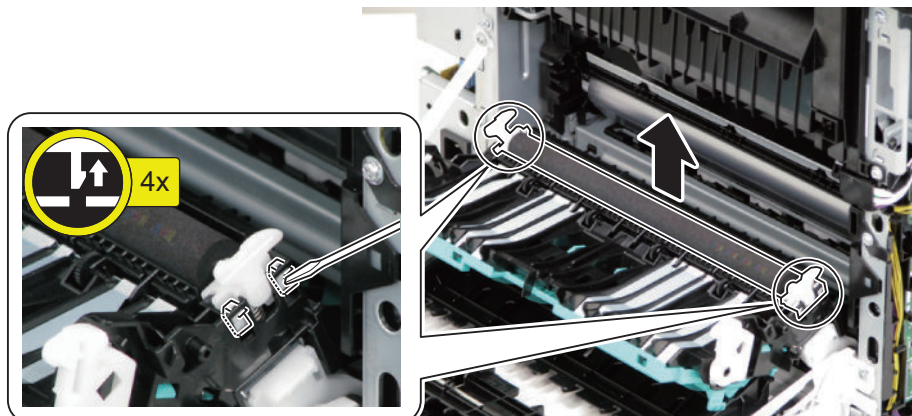

## ● Removing the Secondary Transfer Feed Unit

### ■ Preparation

1. “Removing the Toner Cartridge” on page 75
2. “Removing the Left Cover” on page 76
3. “Removing the Right Cover” on page 78
4. “Removing the Rear Cover Unit” on page 80

### ■ Procedure

1. Remove the Shaft Spacer on the rear left side.

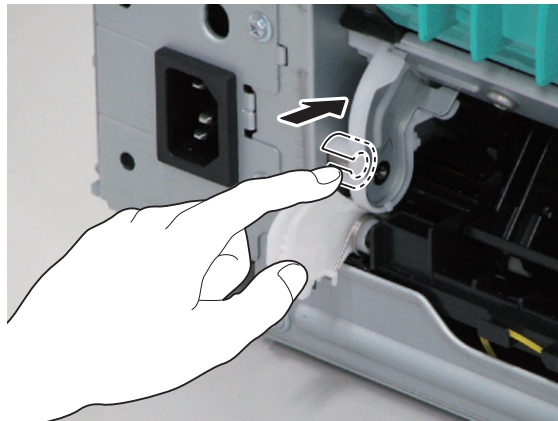

#### **NOTE:**

When installing the Shaft Spacer, install it with the Secondary Transfer Feed Unit opened. Be sure to check the installation position of the stopper.

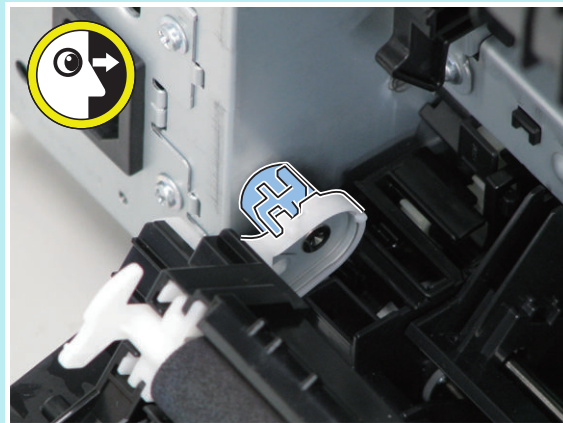

## 2. Open the Secondary Transfer Feed Unit, and then remove the Secondary Transfer Feed Unit.

### NOTE:

Remove the Secondary Transfer Feed Unit by lifting the whole unit and moving it to the left while pushing down the gear on the left with a finger so that the gear does not interfere with the unit.

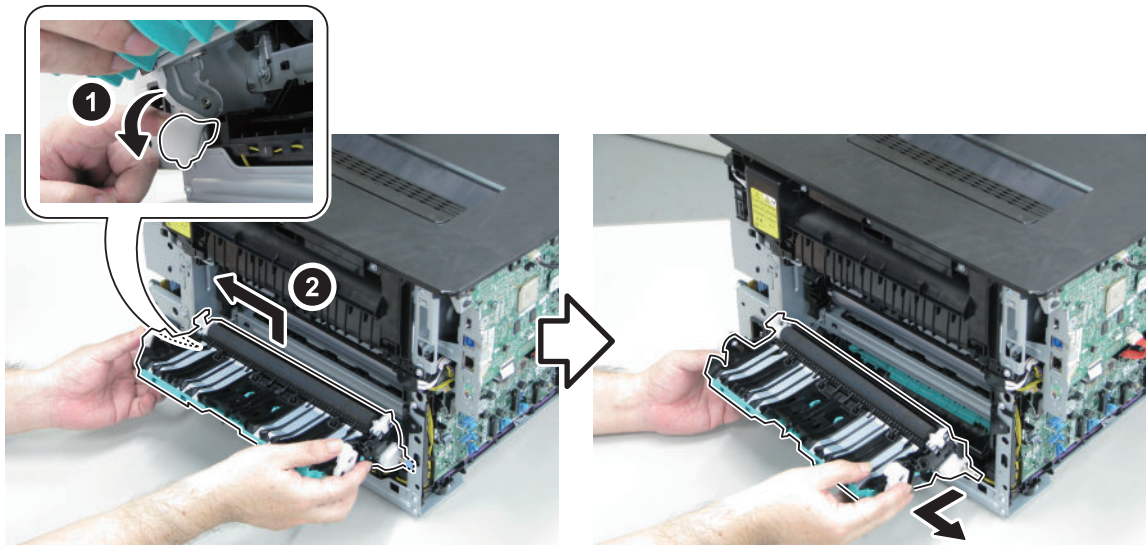

## Removing the ITB Unit

### ■ Preparation

1. “Removing the Toner Cartridge” on page 75
2. “Removing the Left Cover” on page 76
3. “Removing the Right Cover” on page 78
4. “Removing the Rear Cover Unit” on page 80
5. “Removing the Secondary Transfer Feed Unit” on page 108

### ■ Procedure

#### CAUTION:

- Place the ITB Unit on a sheet of paper.
- Be sure not to damage or touch the ITB Unit.

1. Remove the Connector Cover on the rear right side of the host machine, and disconnect the connectors.

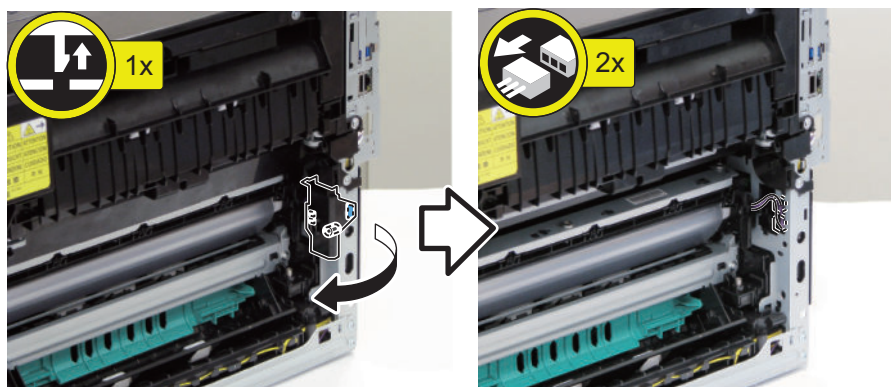

## 2. Remove the Rear Door Open/Close Detection Flag.

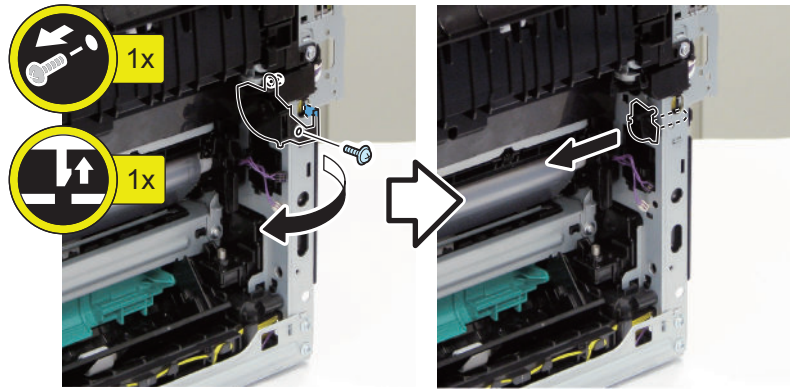

### CAUTION:

When installing the Rear Door Open/Close Detection Flag, install it to the position where it pushes the lever of the microswitch.

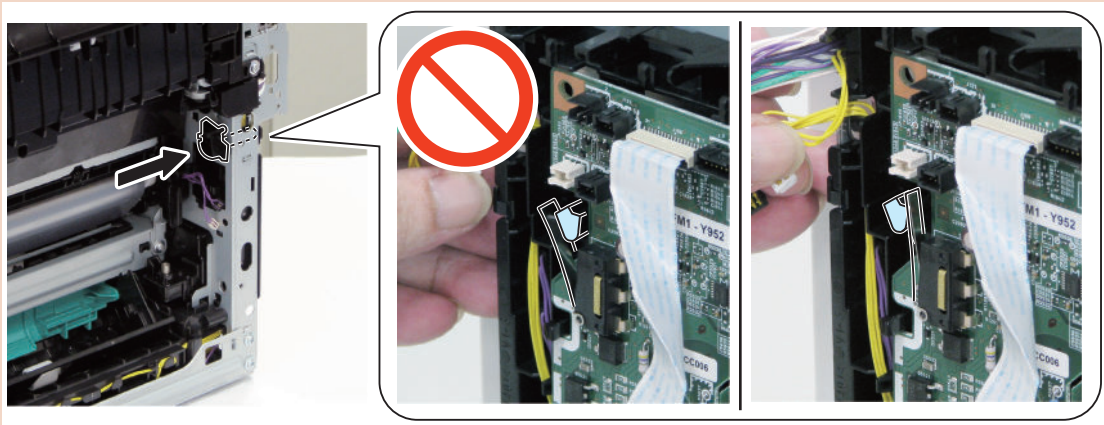

## 3. Remove the ITB Unit Upper Cover from the rear of the host machine.

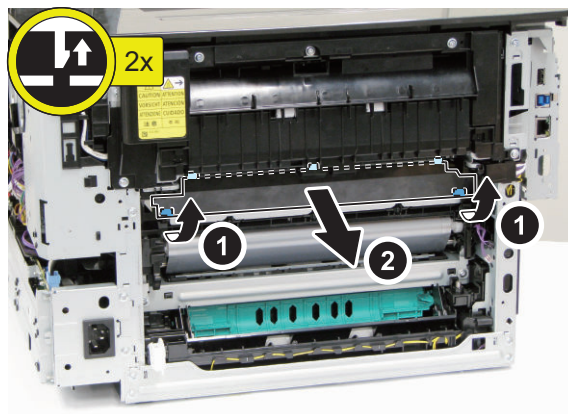

4. While releasing the lock of the 2 white levers by pushing them respectively to the direction of the arrow 1, move them to the mark 2. Then pull out the levers toward the front until they stop.

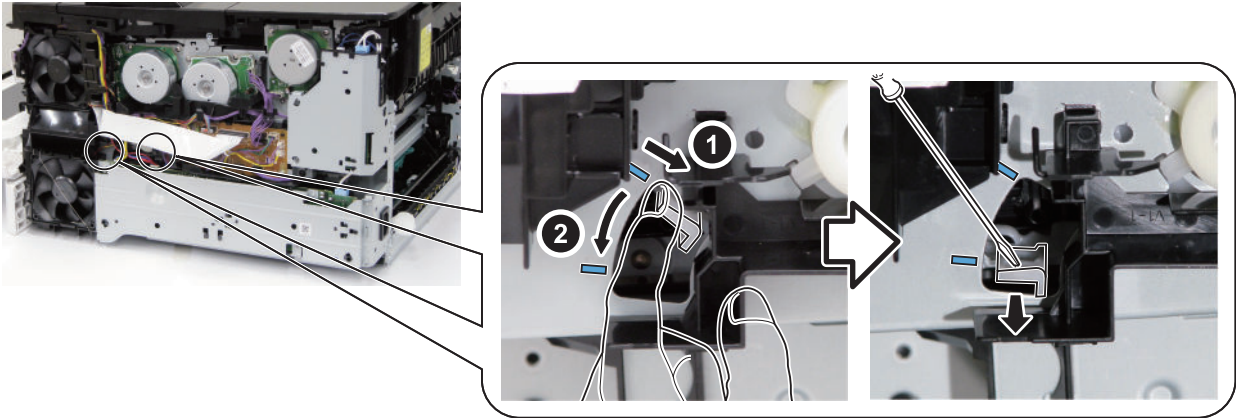
**NOTE:**

For installation, while pushing the two levers respectively toward the rear and then to the direction of the arrow 2, move them to the position of the upper mark.

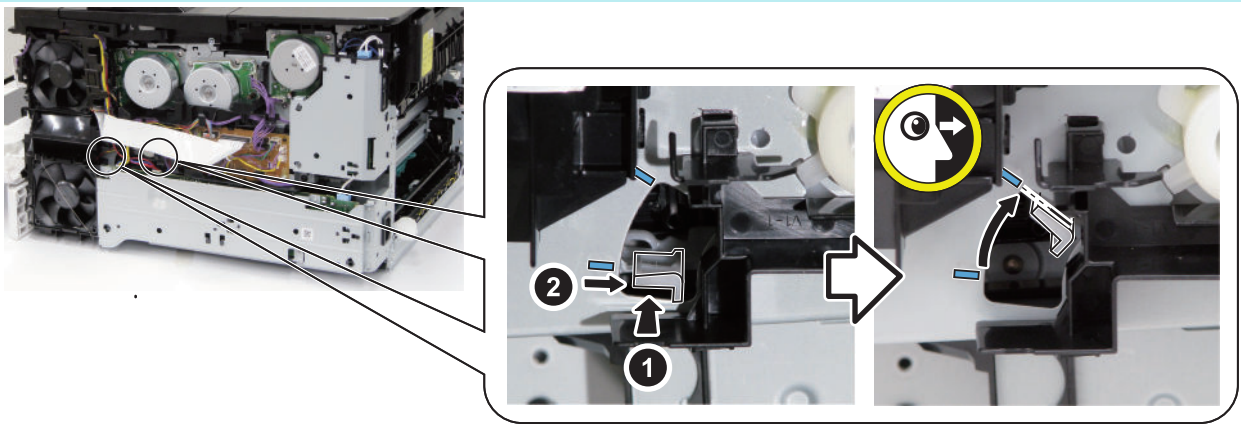

5. Remove the screws, and pull out the ITB Unit while holding the 2 levers on the left and right sides.

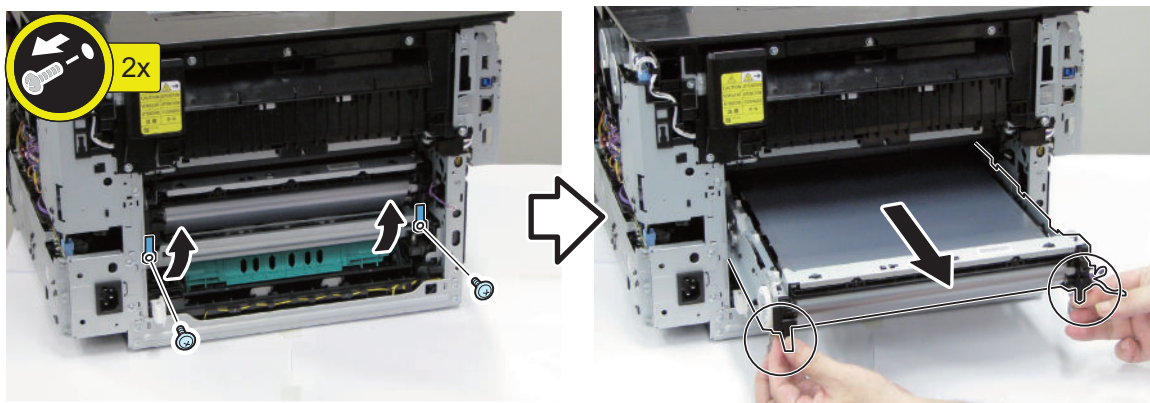

6. Actions after replacement: [“After Replacing the ITB Unit” on page 136](#)

## ● Removing the Color Displacement Density Sensor Unit

### ■ Preparation

1. [“Removing the Toner Cartridge” on page 75](#)
2. [“Removing the Left Cover” on page 76](#)

3. [“Removing the Right Cover”](#) on page 78
4. [“Removing the Rear Cover Unit”](#) on page 80
5. [“Removing the Secondary Transfer Feed Unit”](#) on page 108
6. [“Removing the ITB Unit”](#) on page 109
7. [“Removing the Cartridge Cover ”](#) on page 80

## ■ Procedure

1. Remove the Color Displacement Density Sensor Unit.

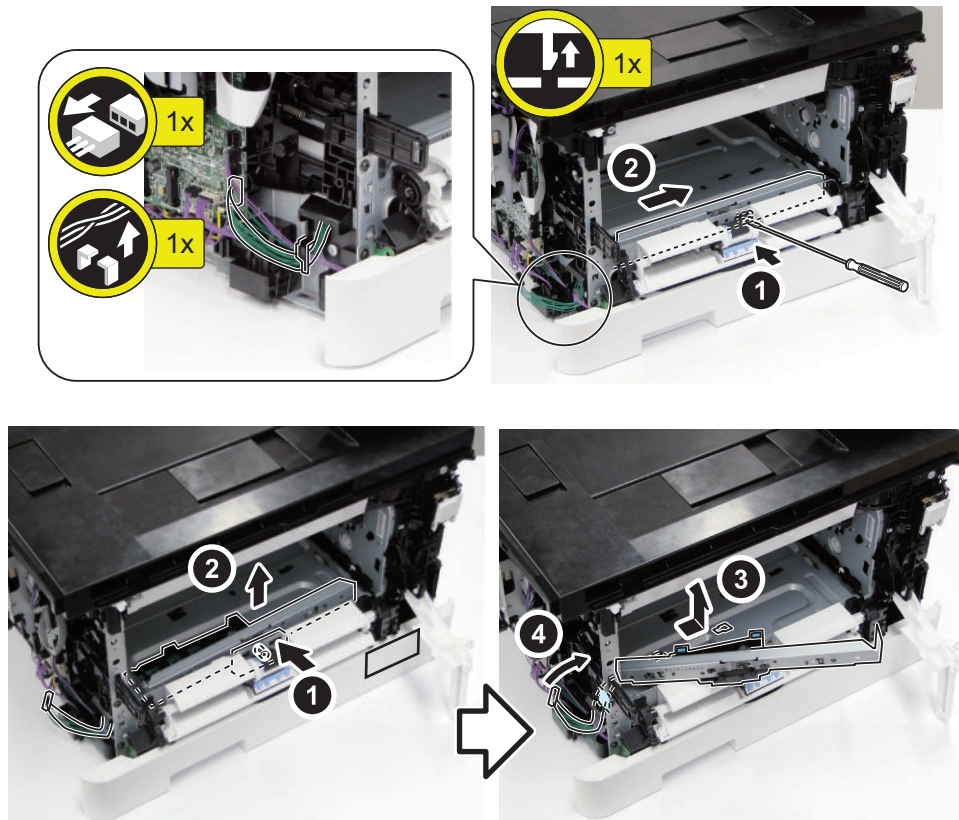

2. Actions after replacement: [“After Replacing the Color Displacement Density Sensor Unit”](#) on page 136

## ● Removing the Developing Motor

### ■ Preparation

1. [“Removing the Toner Cartridge”](#) on page 75
2. [“Removing the Right Cover”](#) on page 78
3. [“Removing the Low Voltage Power Supply Unit”](#) on page 90
4. [“Removing the Driver PCB”](#) on page 97



## ■ Procedure

### 1. Free the harness.

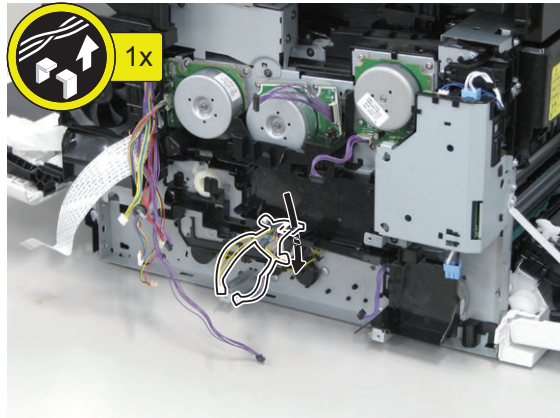

### 2. Remove the PCB Guide.

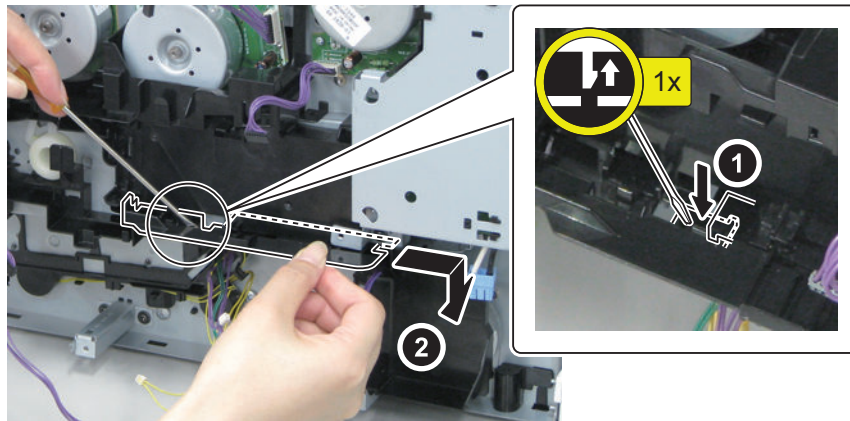

### 3. Remove the PCB Holder.

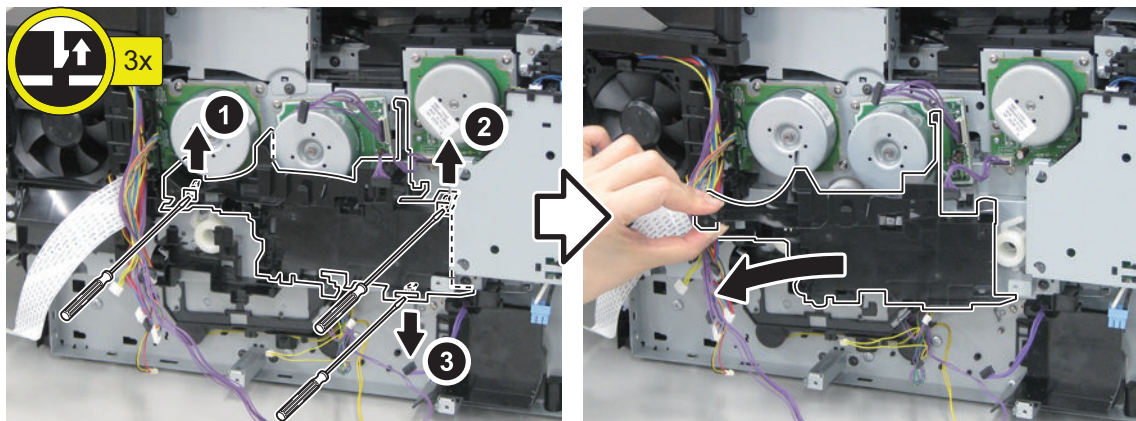

## 4. Remove the Developing Motor.

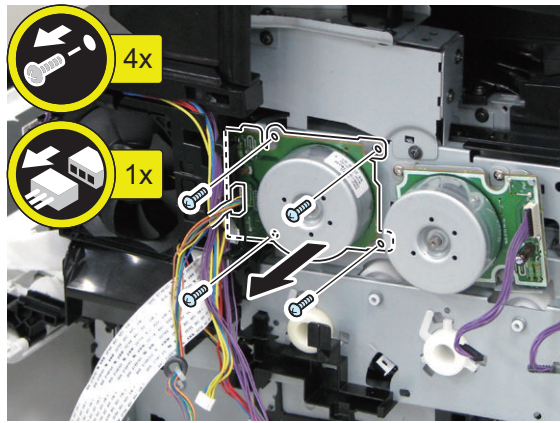

## ● Removing the Drum Motor

### ■ Preparation

1. "Removing the Toner Cartridge" on page 75
2. "Removing the Right Cover" on page 78
3. "Removing the Low Voltage Power Supply Unit" on page 90
4. "Removing the Driver PCB" on page 97

### ■ Procedure

1. Free the harness.

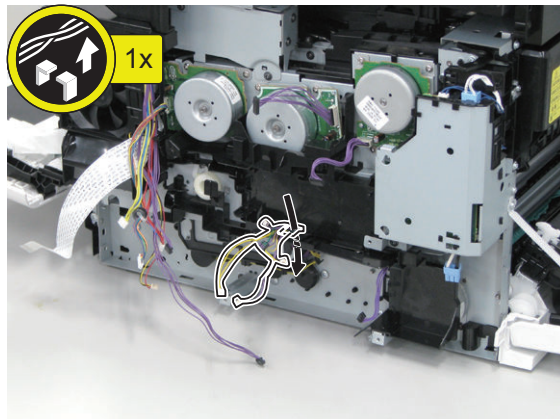

2. Remove the PCB Guide.

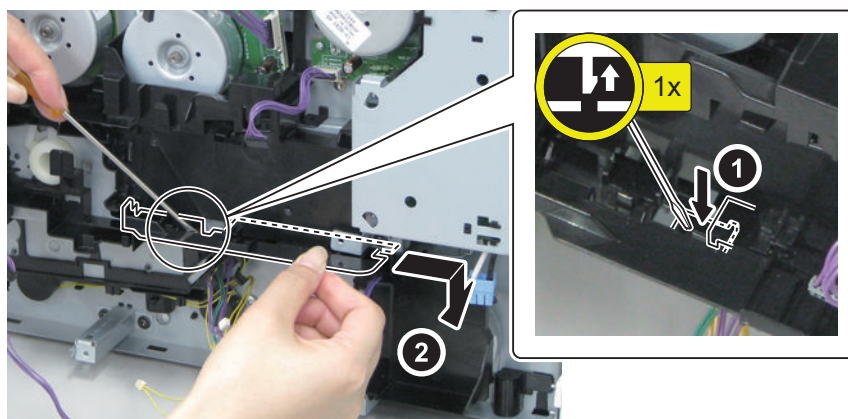

3. Remove the PCB Holder.

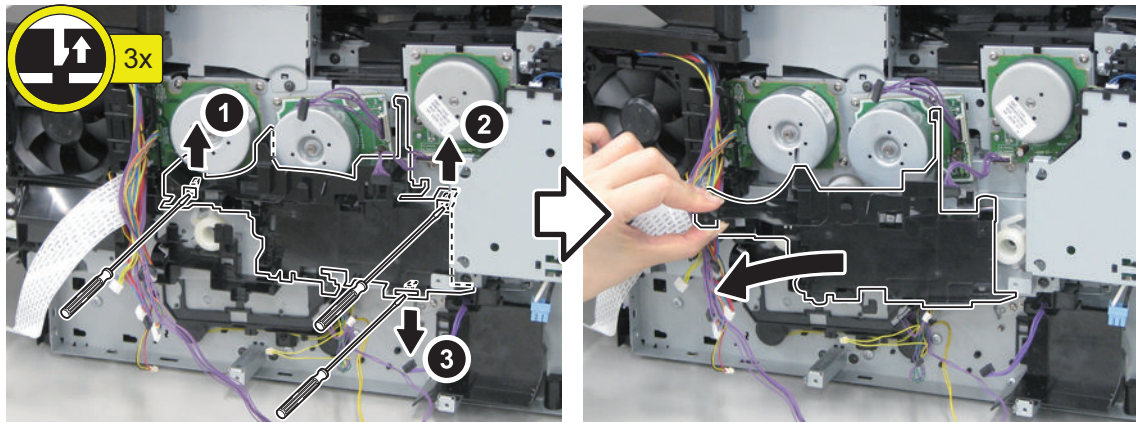

4. Remove the Drum Motor.

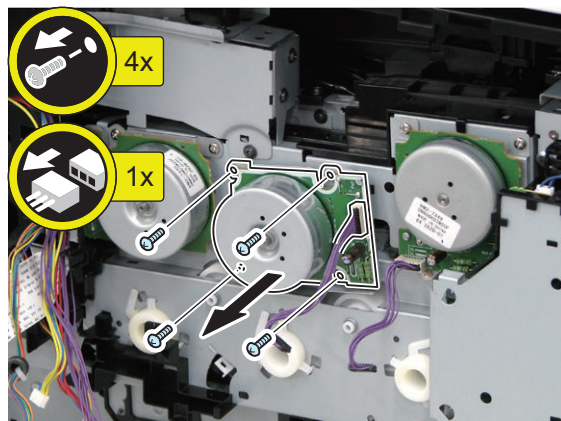

## Fixing System

### ● Removing the Fixing Assembly

#### ■ Preparation

1. "Removing the Toner Cartridge" on page 75
2. "Removing the Left Cover" on page 76
3. "Removing the Right Cover" on page 78
4. "Removing the Control Panel Unit" on page 92
5. "Removing the Control Panel Lower Cover" on page 84
6. "Removing the Upper Cover Unit" on page 85
7. "Removing the Controller Cover" on page 87
8. "Removing the Main Controller PCB" on page 88
9. "Removing the Wireless LAN Support Plate (Wi-Fi model only)" on page 88
10. "Removing the Main Controller Support Plate" on page 89

#### ■ Procedure

##### CAUTION:

Since the Fixing Assembly is hot immediately after the power is turned OFF, give it time to cool down before removing it.

1. Remove the Rear Upper Unit Plate.

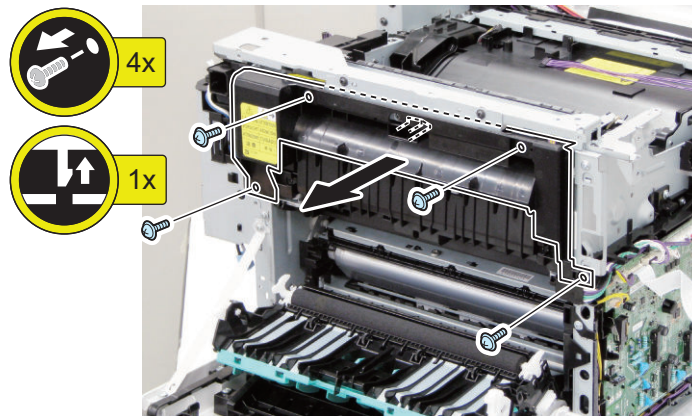

2. Free the harness.

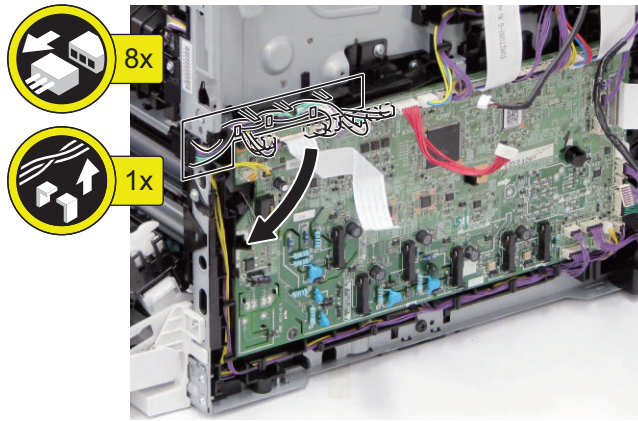

3. Disconnect the connectors and free the harness.

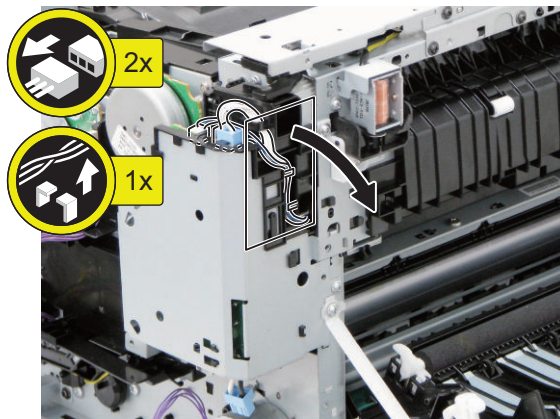

4. Remove the Rear Upper Plate.

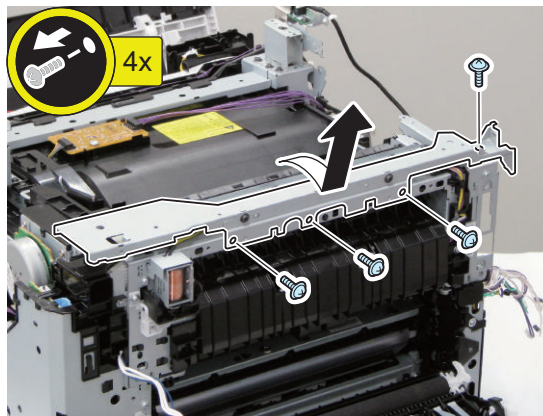

## 5. Remove the Fixing Assembly.

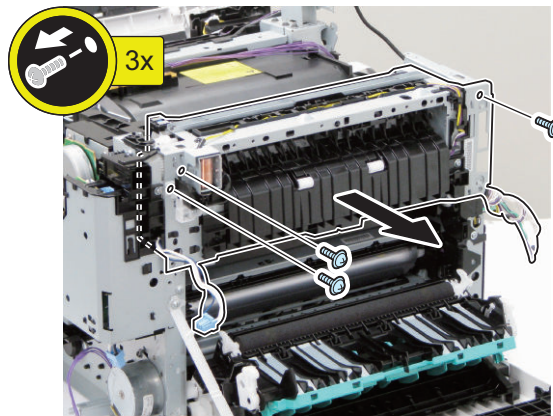
**CAUTION:**

When installing it, be careful not to let the Reverse Lever come in contact with the frame of the printer. Also be careful not to let it slip under the Reverse Stopper of the Reverse Drive Assembly.

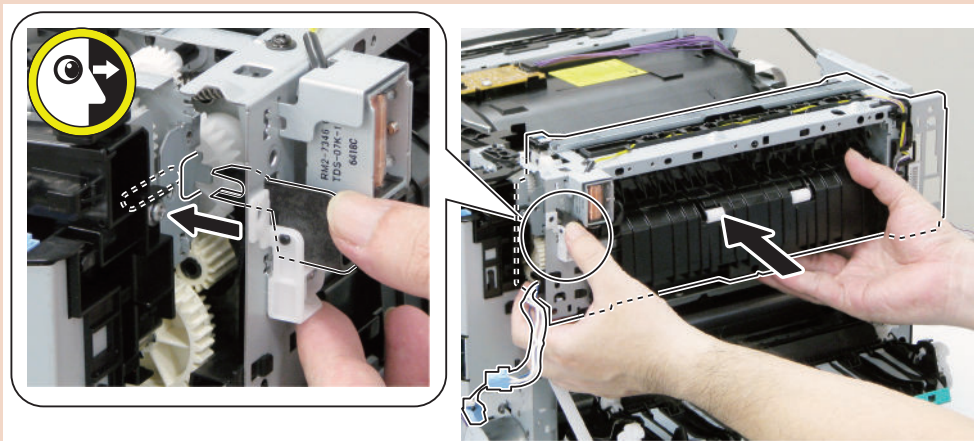

## ● Removing the Fixing Power Supply Unit

### ■ Preparation

1. "Removing the Toner Cartridge" on page 75
2. "Removing the Right Cover" on page 78

## ■ Procedure

1. Remove the Fixing Power Supply Unit.

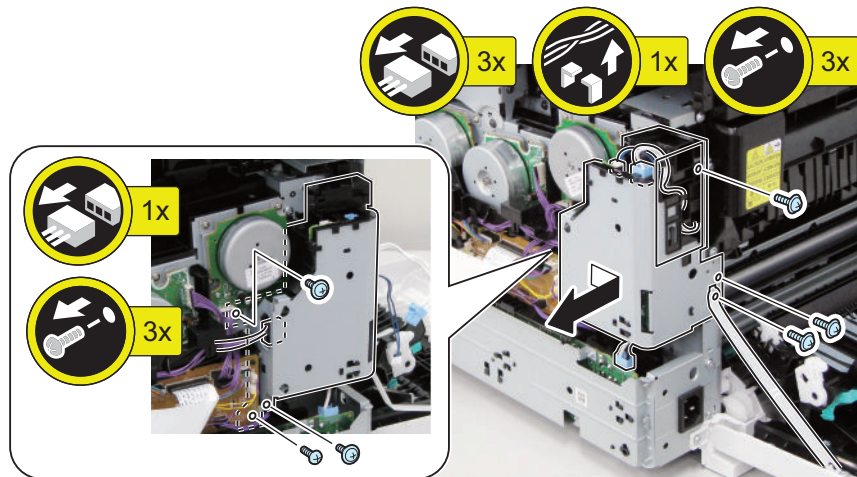

## ● Removing the Fixing Motor

### ■ Preparation

1. “Removing the Toner Cartridge” on page 75
2. “Removing the Right Cover” on page 78
3. “Removing the Fixing Power Supply Unit” on page 118

### ■ Procedure

1. Remove the Fixing Motor.

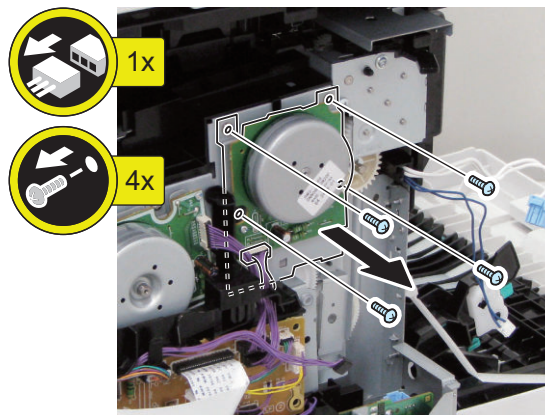

## Pickup Feed Delivery System

### ● Removing the Cassette Pickup Roller/Feed Roller Unit

#### ■ Preparation

1. "Removing the Toner Cartridge" on page 75

#### ■ Procedure

##### CAUTION:

Be sure not to touch the surface of the Cassette Pickup Roller and the surface of the Feed Roller.

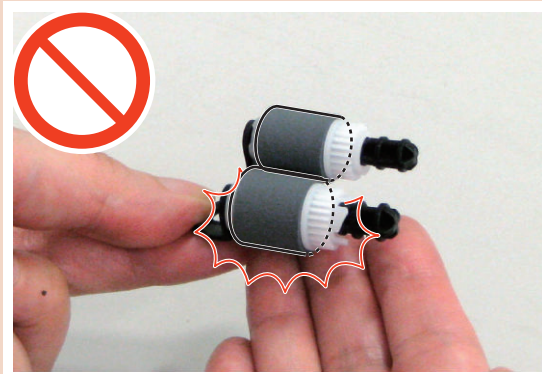

1. Pull out the cassette, and stand the host machine with its left side down.

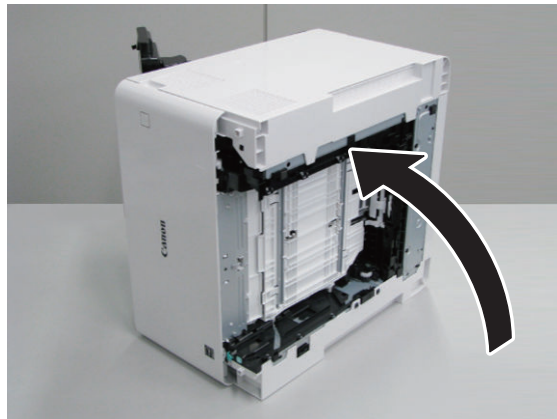

2. Move the Multi-purpose Tray Feed Guide in the direction of the arrow (2).

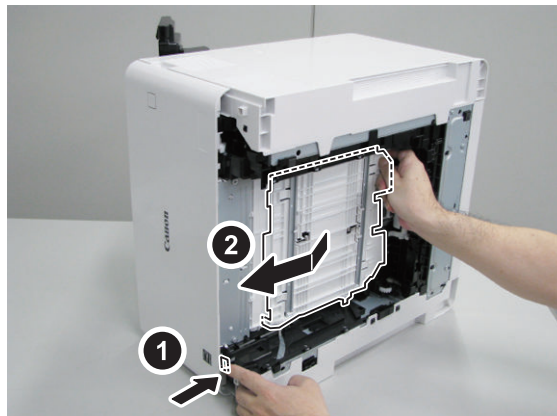



3. Push the lever, move the Roller Retainer to the direction of the arrow, and remove the Pickup Roller and the Feed Roller.

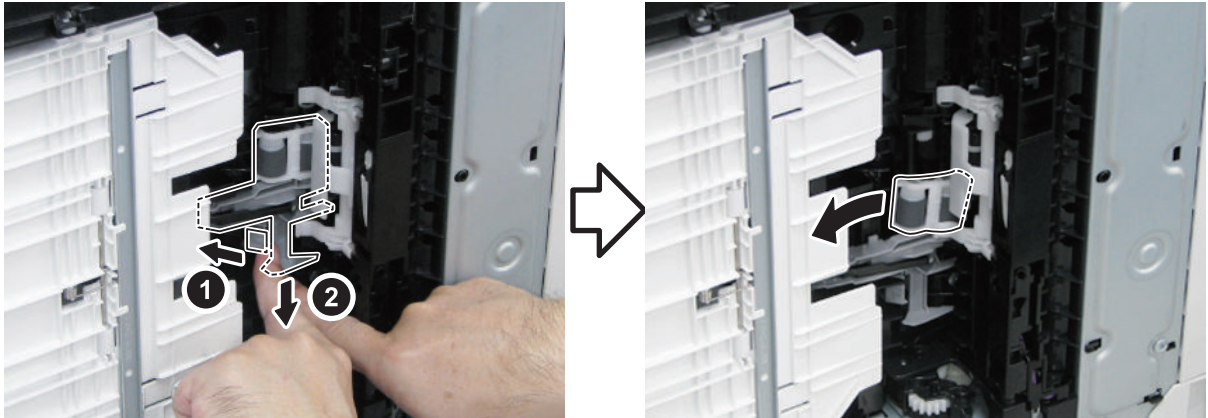

## ● Removing the Cassette Separation Roller Unit

### ■ Preparation

1. "Removing the Toner Cartridge" on page 75

### ■ Procedure

#### CAUTION:

Be sure not to touch the surface of the Separation Roller.



1. Pull out the cassette, and stand the host machine with its left side down.

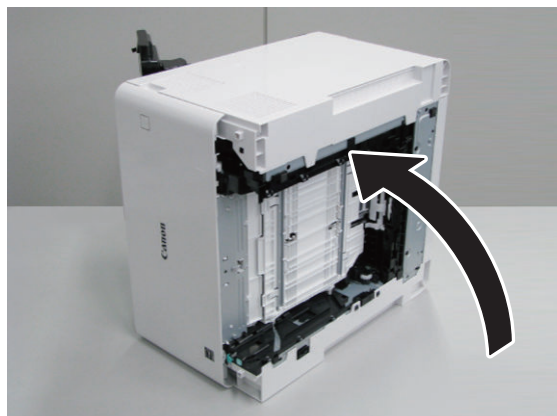

## 2. Remove the Separation Roller Guide.

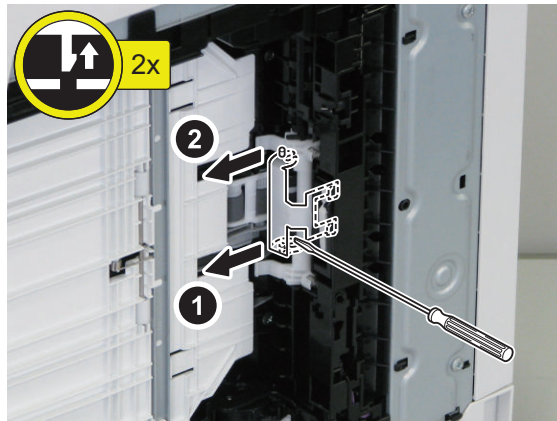

## 3. Remove the Separation Roller.

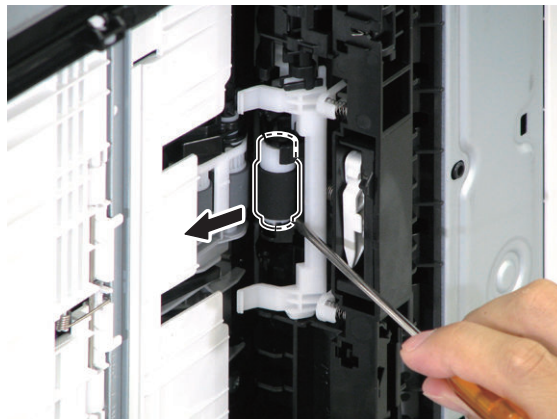

### NOTE:

When installing the Separation Roller, be sure to properly fit the D-cut.



## ● Removing the Duplex Reverse Drive Unit

### ■ Preparation

1. "Removing the Toner Cartridge" on page 75
2. "Removing the Left Cover" on page 76
3. "Removing the Right Cover" on page 78
4. "Removing the Control Panel Unit" on page 92

5. "Removing the Control Panel Lower Cover" on page 84
6. "Removing the Upper Cover Unit " on page 85
7. "Removing the Controller Cover " on page 87
8. "Removing the Main Controller PCB" on page 88
9. "Removing the Wireless LAN Support Plate (Wi-Fi model only)" on page 88
10. "Removing the Main Controller Support Plate" on page 89
11. "Removing the Fixing Assembly" on page 116
12. "Removing the Fixing Power Supply Unit" on page 118

## ■ Procedure

1. Remove the Duplex Reverse Drive Unit.

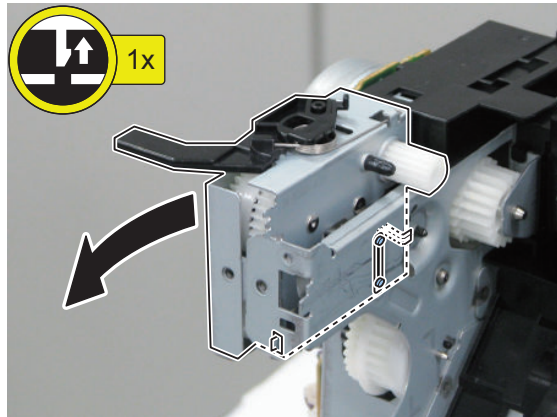

## ● Removing the Pickup Motor

### ■ Preparation

1. "Removing the Left Cover" on page 76
2. "Removing the Right Cover" on page 78
3. "Removing the Low Voltage Power Supply Unit" on page 90

### ■ Procedure

1. Remove the cover.

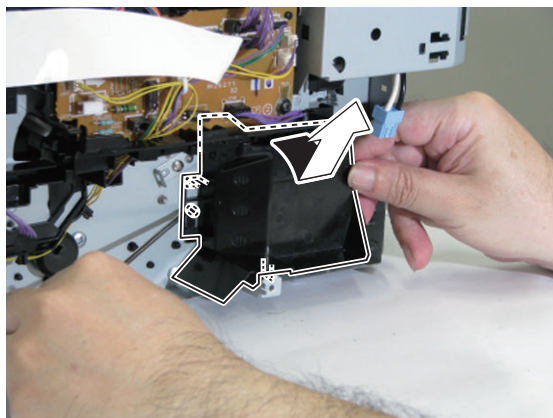

## 2. Remove the Pickup Motor.

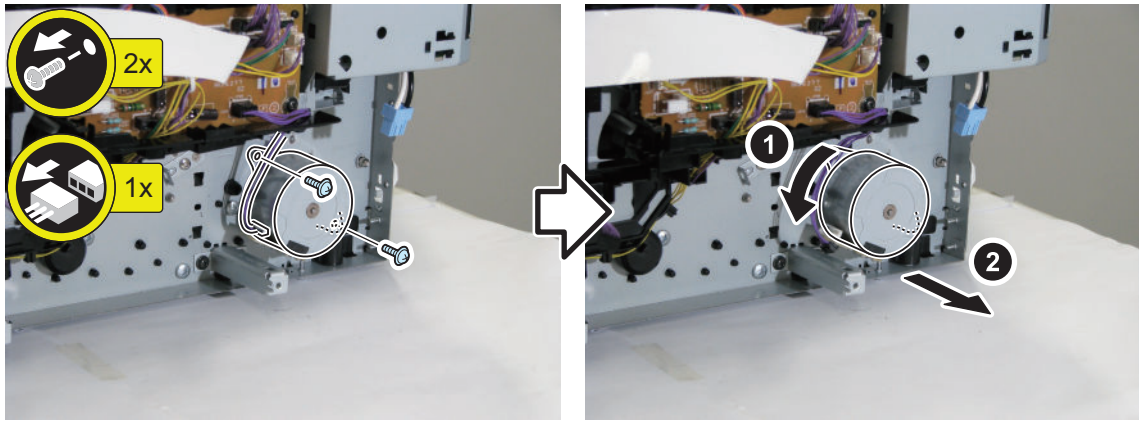

## ● Removing the Re-Pickup Unit

### ■ Preparation

1. “Removing the Toner Cartridge” on page 75
2. “Removing the Left Cover” on page 76
3. “Removing the Right Cover” on page 78
4. “Removing the Rear Cover Unit” on page 80
5. “Removing the Controller Cover ” on page 87
6. “Removing the Main Controller PCB” on page 88
7. “Removing the Wireless LAN Support Plate (Wi-Fi model only)” on page 88
8. “Removing the Main Controller Support Plate” on page 89

### ■ Procedure

1. Stand the host machine with its right side down.

**CAUTION:**

Be careful not to damage the Control Panel and parts.

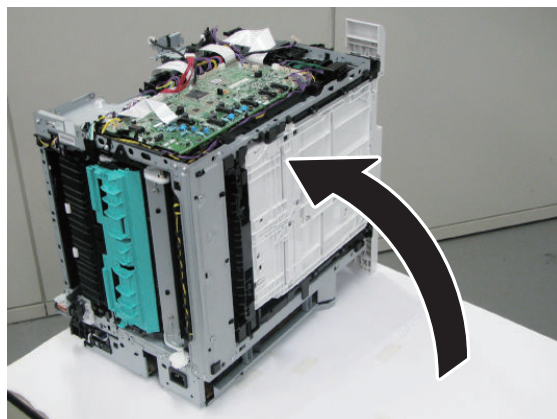

2. Disconnect the connectors and remove the screws. Be sure to remove the screws in the order from 1 to 6.

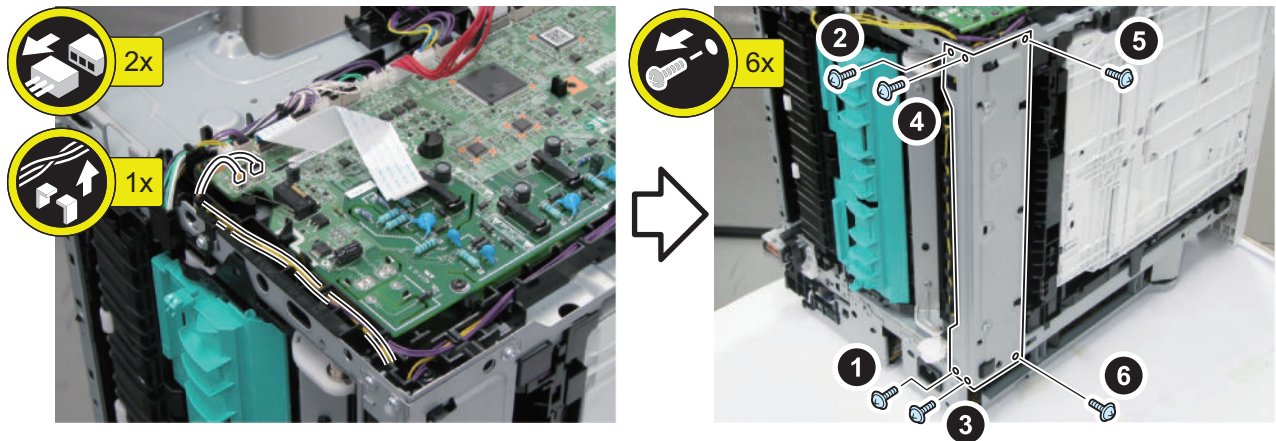

3. Remove the Re-Pickup Unit.

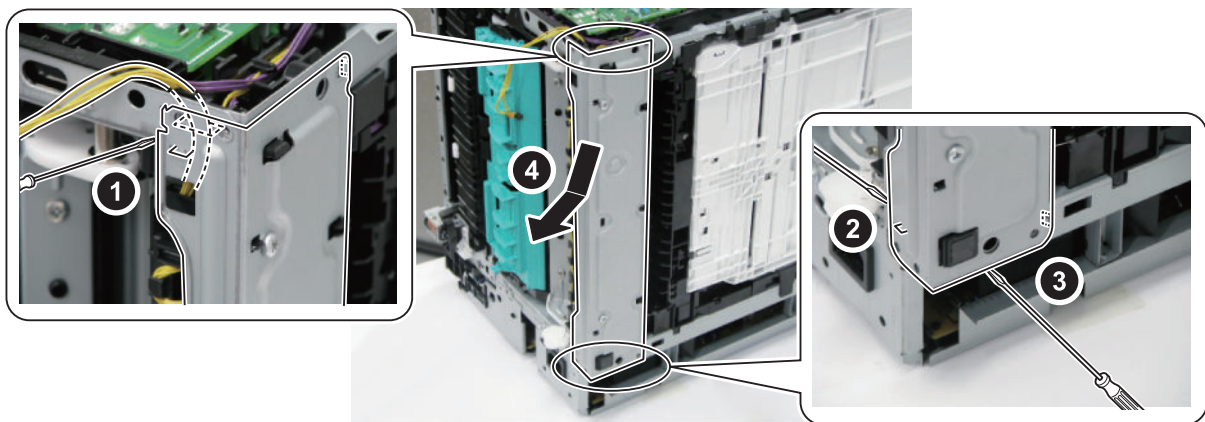

**NOTE:**

At installation,

- By removing the block with rubber from the bottom of the host machine, the Re-Pickup Unit can be installed easily.
- Tighten the screws in the order they were removed.

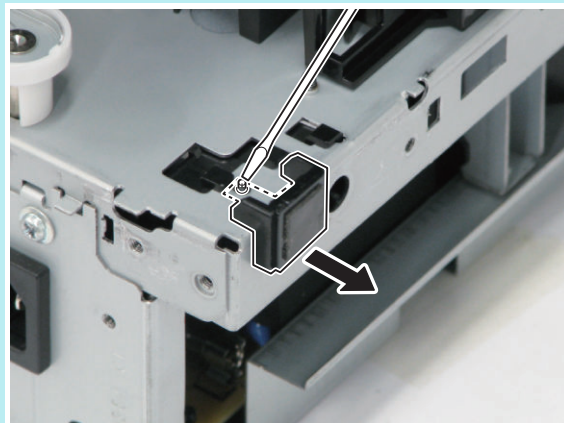

## ● Removing the Lifter Drive Unit

### ■ Preparation

1. "Removing the Toner Cartridge" on page 75
2. "Removing the Left Cover" on page 76
3. "Removing the Right Cover" on page 78

4. "Removing the Control Panel Unit" on page 92
5. "Removing the Control Panel Lower Cover" on page 84
6. "Removing the Upper Cover Unit " on page 85
7. "Removing the Rear Cover Unit" on page 80
8. "Removing the Controller Cover " on page 87
9. "Removing the Main Controller PCB" on page 88
10. "Removing the Wireless LAN Support Plate (Wi-Fi model only)" on page 88
11. "Removing the Main Controller Support Plate" on page 89
12. "Removing the Engine Controller PCB" on page 89
13. Pull out the cassette.
14. "Removing the Re-Pickup Unit" on page 124

## ■ Procedure

1. Free the harness, and remove the screws, Shaft Cover, and shaft.

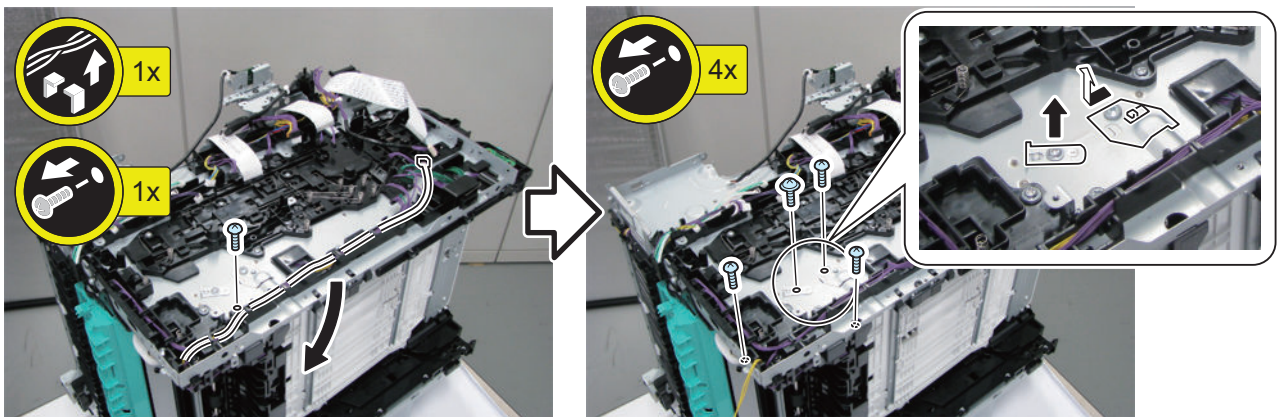

2. Remove the block with rubber.

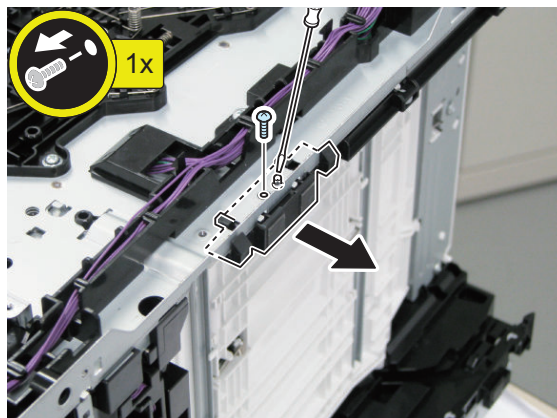

## 3. Remove the Cassette Detection Switch.

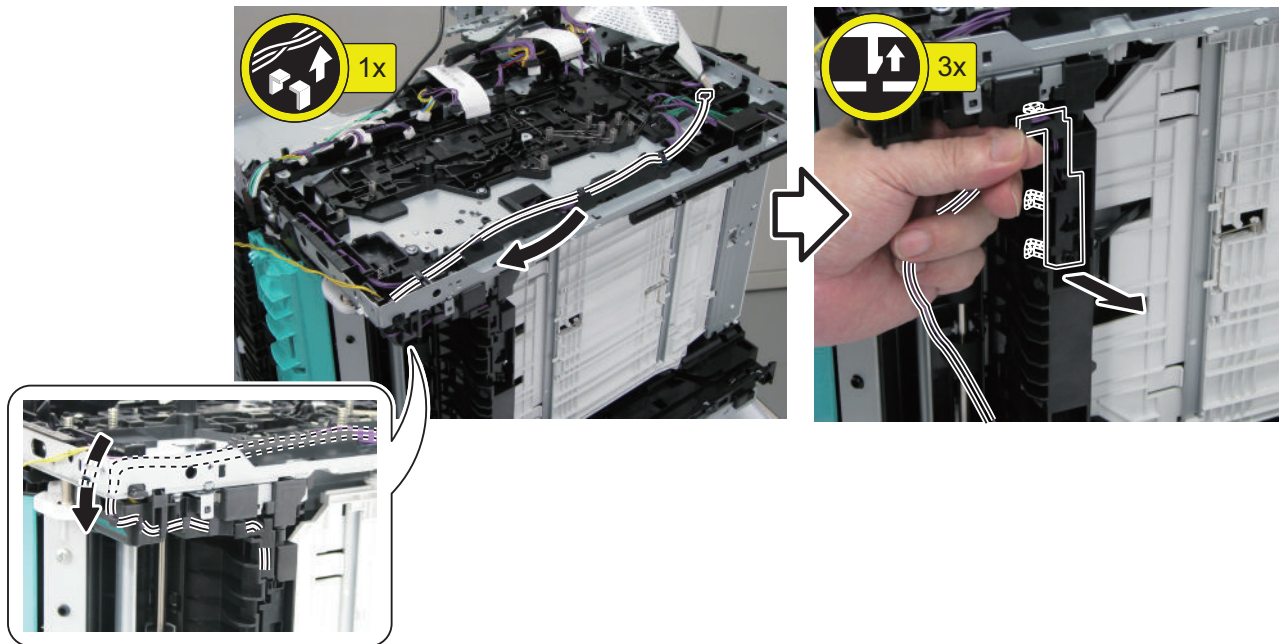

## 4. Remove the Lifter Drive Unit.

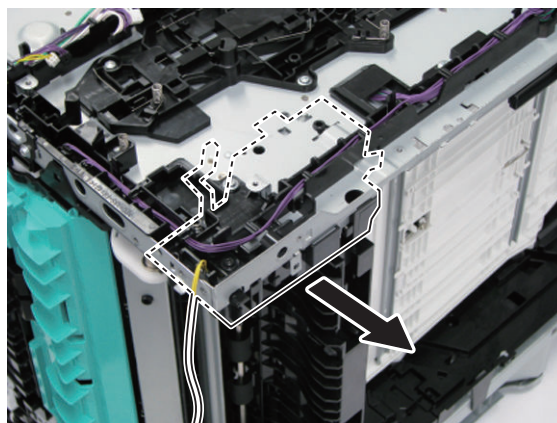

## ● Removing the Cassette Pickup Unit

### ■ Preparation

1. "Removing the Toner Cartridge" on page 75
2. "Removing the Left Cover" on page 76
3. "Removing the Right Cover" on page 78
4. "Removing the Rear Cover Unit" on page 80
5. "Removing the Controller Cover" on page 87
6. "Removing the Main Controller PCB" on page 88
7. "Removing the Wireless LAN Support Plate (Wi-Fi model only)" on page 88
8. "Removing the Main Controller Support Plate" on page 89
9. "Removing the Engine Controller PCB" on page 89
10. Pull out the cassette.
11. "Removing the Low Voltage Power Supply Unit" on page 90

- 12. "Removing the Re-Pickup Unit" on page 124
- 13. "Removing the Lifter Drive Unit" on page 125
- 14. "Removing the Pickup Motor" on page 123

## ■ Procedure

- 1. Remove the harness guide.

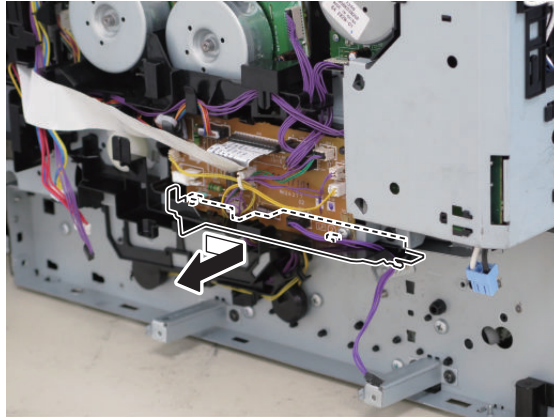

- 2. Remove the connector and harness.

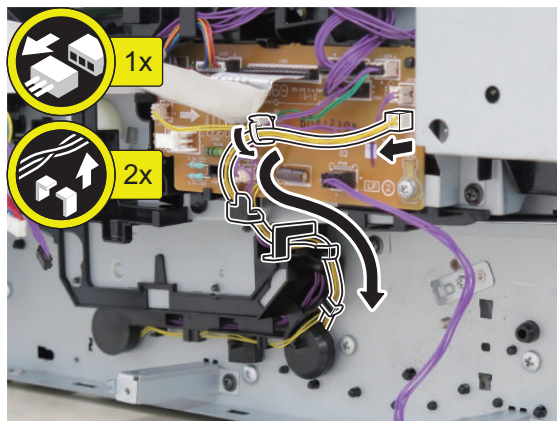

- 3. Remove the screws.

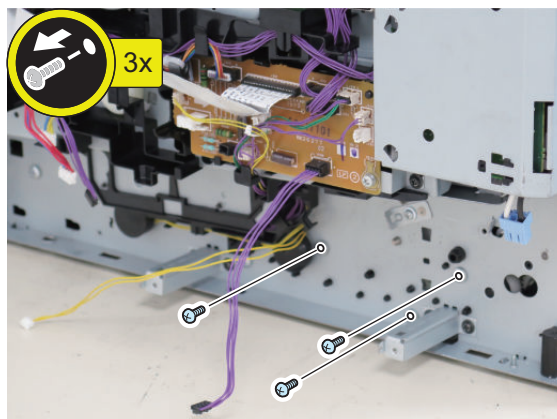



4. Stand the host machine with its right side down, and remove the Cassette Pickup Unit.

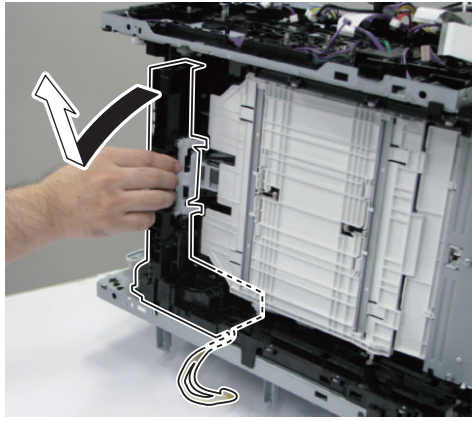

## ● Removing the Multi-purpose Tray Pickup Roller

### ■ Procedure

**CAUTION:**

Be sure not to touch the surface of the Multi-purpose Tray Pickup Roller.

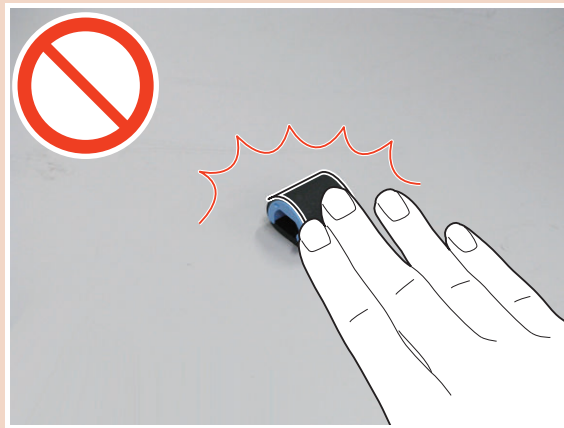

1. Open the Cartridge Cover.
2. Remove the Multi-purpose Tray Pickup Roller.

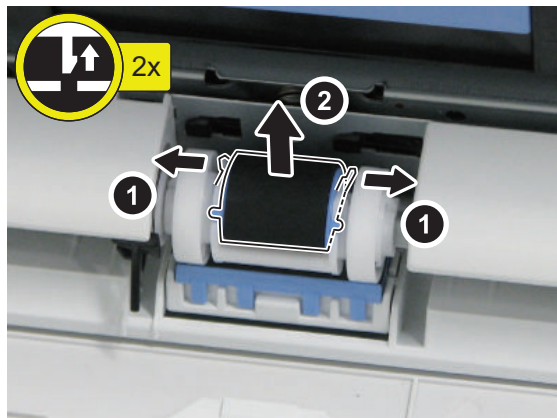

## ● Removing the Multi-purpose Tray Separation Pad

### ■ Procedure

**CAUTION:**

Be sure not to touch the surface of the Multi-purpose Tray Separation Pad.

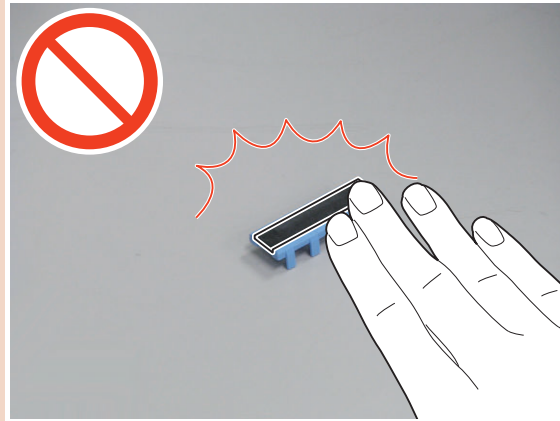

1. Open the Cartridge Cover.
2. Lower the Multi-purpose Tray Separation Pad.

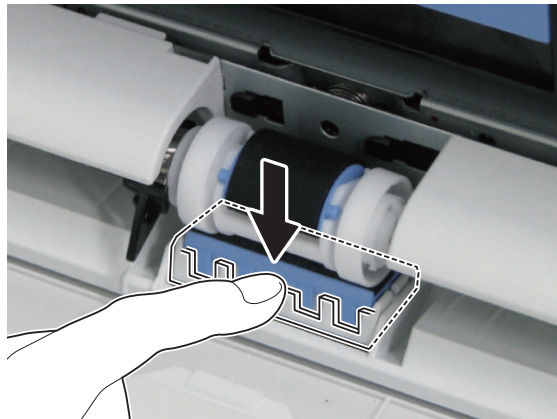

3. Remove the Multi-purpose Tray Separation Pad.

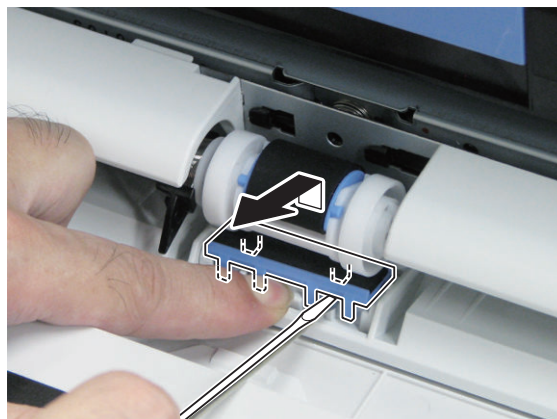

## Removing the Registration Unit

### ■ Preparation

1. “Removing the Toner Cartridge” on page 75
2. “Removing the Left Cover” on page 76
3. “Removing the Right Cover” on page 78
4. “Removing the Control Panel Unit” on page 92
5. “Removing the Control Panel Lower Cover” on page 84
6. “Removing the Upper Cover Unit ” on page 85
7. “Removing the Rear Cover Unit” on page 80
8. “Removing the Controller Cover ” on page 87
9. “Removing the Main Controller PCB” on page 88
10. “Removing the Wireless LAN Support Plate (Wi-Fi model only)” on page 88
11. “Removing the Main Controller Support Plate” on page 89
12. “Removing the Engine Controller PCB” on page 89
13. “Removing the Low Voltage Power Supply Unit” on page 90
14. “Removing the Re-Pickup Unit” on page 124
15. “Removing the Lifter Drive Unit” on page 125
16. “Removing the Pickup Motor” on page 123
17. “Removing the Cassette Pickup Unit” on page 127

### ■ Procedure

1. Free the harness.

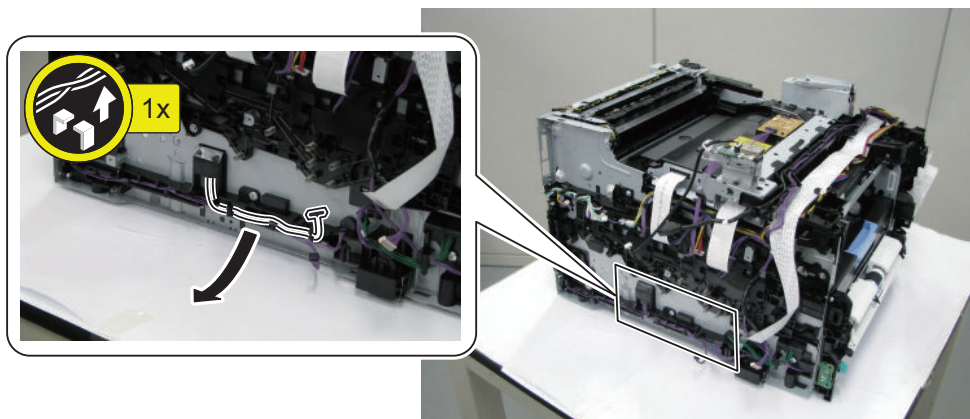

2. Remove the shaft.

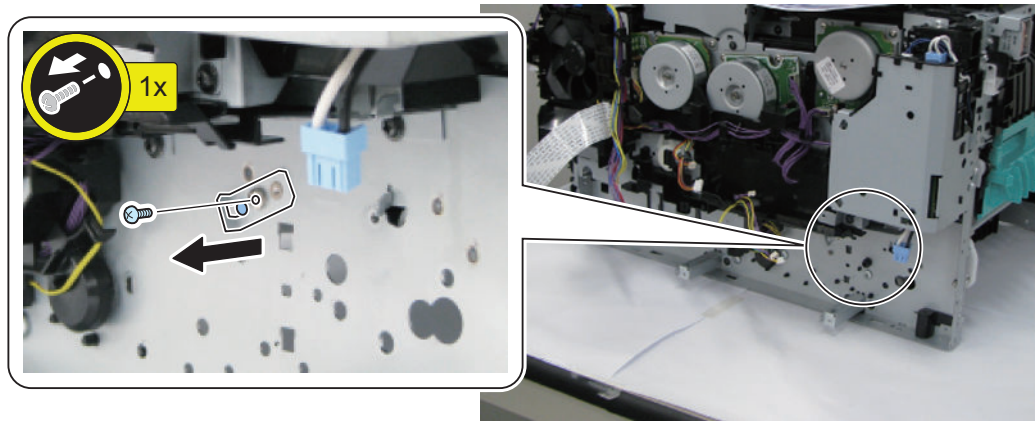

3. Stand the host machine with its right side down.

4. Move the Multi-purpose Tray Feed Guide in the direction of the arrow (2).

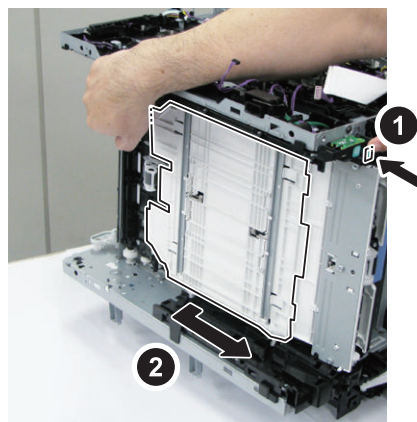

5. Remove the screws in the order of numbers in the illustration.

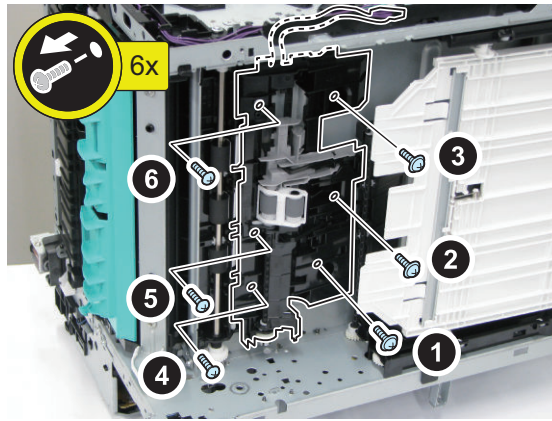

**NOTE:**

When installing it, tighten the screws in the order of numbers in the illustration.

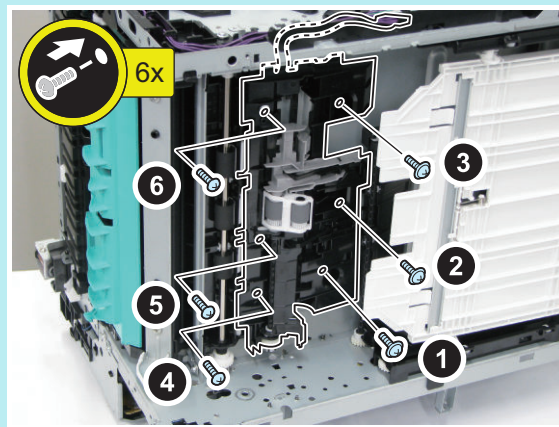

6. Remove the Feed Front Guide and the Feed Rear Guide together.

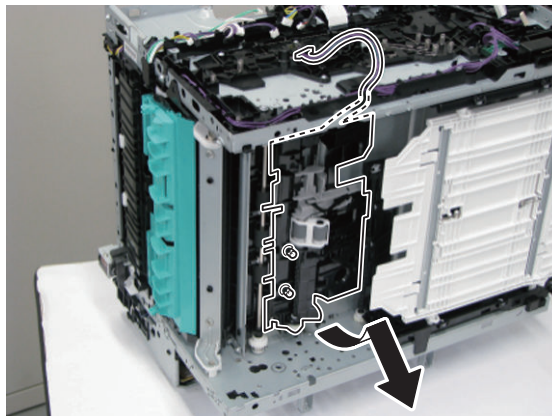

7. Remove the Registration Unit.

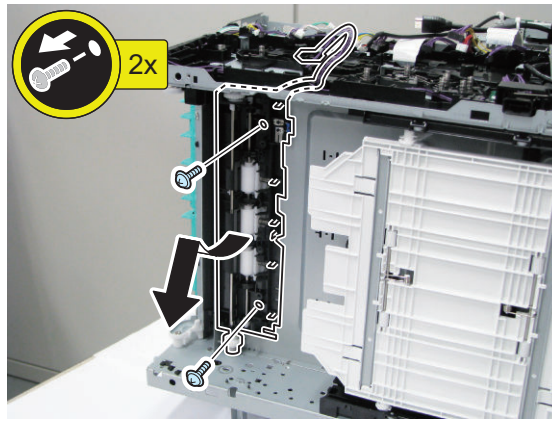



# Adjustment

Adjustment at Parts Replacement.... 136

## Adjustment at Parts Replacement

### After Replacing the Control Panel

1. Execute the following service mode to adjust the coordinate position on the touch panel.
  - COPIER > ADJUST > PANEL > TOUCHCHK
2. Check that the service mode setting value is "1" in the following service mode.
  - COPIER > ADJUST > PANEL > TOUCH-R

**CAUTION:**

When the value is not "1" in the above service mode, re-adjust the coordinate position on the touch panel.

### After Replacing the ITB Unit

1. Perform the following
  - Adjustment / Maintenance >> Adjust Image Quality > Quick Adjust

### After Replacing the Color Displacement Density Sensor Unit

1. Perform the following
  - Adjustment / Maintenance >> Adjust Image Quality > Quick Adjust

### Engine Controller PCB

#### Before Replacing the Engine Controller PCB

The setting values stored in the Engine Controller PCB NVRAM can be backed up to the Main Controller PCB NVRAM. The setting values can be backed up by performing the following method.

- SERVICE MODE > COPIER > FUNCTION > VIFFNC > STOR-DCN

Turn OFF and then ON the power.

**CAUTION:**

Perform backup immediately before replacing the Engine Controller PCB.

#### After Replacing the Engine Controller PCB

The setting values of the NVRAM on the Engine Controller PCB are stored in the NVRAM on the Main Controller PCB as a backup.

The setting values can be restored by performing the following method.

- SERVICE MODE > COPIER > FUNCTION > VIFFNC > RSTR-DCN

Turn OFF and then ON the power.

### Main Controller PCB

#### Before Replacing the Main Controller PCB

The following setting values are recorded in the Main Controller PCB. When the Main Controller PCB is replaced, these setting values are all returned to the default unless they are restored.

- User mode setting values
- Service mode setting values

These setting values can be restored by performing backup by either of the following methods.

Refer to the Backup List for the details of items that are backed up. ["Backup Data List" on page 217](#)

- SERVICE MODE > COPIER > FUNCTION > SYSTEM > EXPORT



- Menu > Management Settings > Data Management > Import/Export > Export
- RUI > Settings/Registration > Management Settings > Data Management > Import/Export > Export

**CAUTION:**

Perform backup immediately before replacing the Main Controller PCB.

## ■ After Replacing the Main Controller PCB

### 1. Restore the data in the same way as that of backup. Refer to the Backup List for the setting values that are restored.

Refer to the Backup List for the details of items that are backed up. [“Backup Data List” on page 217](#)

- SERVICE MODE > COPIER > FUNCTION > SYSTEM > IMPORT
- Menu > Management Settings > Import/Export > Export
- RUI > Settings/Registration > Management Settings > Import/Export > Export.

Update firmware as necessary.

**CAUTION:**

Be sure to restore the data after replacing the Main Controller PCB.

### 2. Correct coordinate position of Touch Panel in the following service mode.

- COPIER > ADJUST > PANEL > TOUCHCHK



# Troubleshooting

Test Print.....	139
Troubleshooting Items.....	152
Debug Log.....	154

## Test Print

### Engine Test Print

This machine has an engine test print function to check whether the printer engine is operating normally.

**NOTE:**

In the case of engine test print, a test print can be performed by using only the Engine Controller.

There are two types of engine test print: 1-sided print and 2-sided print\*.

\*: Duplex models only

1. Load A4/LTR paper in the Pickup Tray or Multi-purpose Tray Pickup Tray.
2. While the machine is in the standby mode, open and close the Front Cover [1] for the predetermined number of times in a row.

**CAUTION:**

Be sure to perform the next cycle of open/close within 1.5 seconds after the last cycle of open/close.

- In case of 1-sided print  
4 times
- In case of 2-sided print  
5 times or more

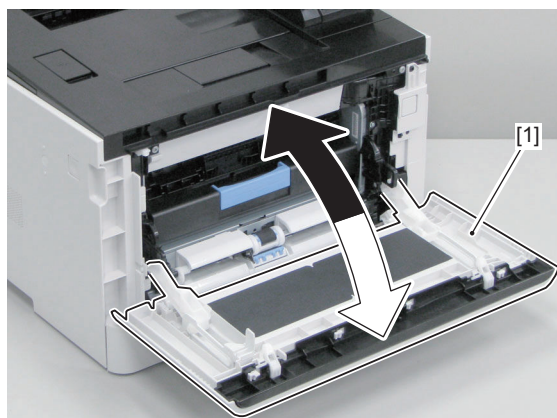

3. An engine test print is executed, and the test pattern as shown below is printed on one side or both sides of a sheet of paper.

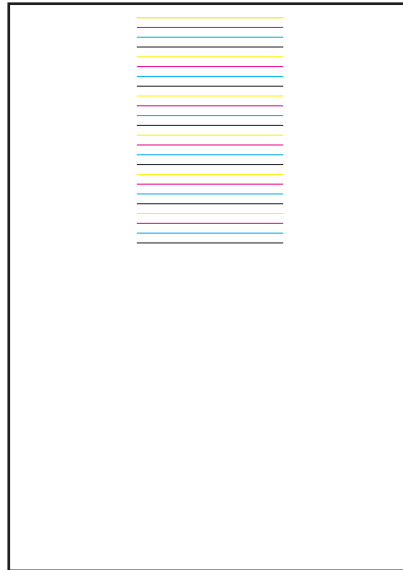

## Controller test print

The following test print types are available with this machine, and you can check for failure of an image with a circle 'Yes' described in the image check items in the table below. When no failure is found in the test print in normal output mode, it can be caused in PDL input or Reader.

The image of the test print is generated by the Main Controller PCB.

PG TYPE	TYPE Pattern	Image check items													
		Grada-tion	Fog-ging	Trans-fer Fault	Black line (Color line)	White line	Un-even Den-sity	Un-even Den-sity at the Front / Rea	Right Angle	Straig-ht Lines	Color dis-placement	Color	Ghost	Den-sity	White spots
0-1	For R&D use														
2	Color chart										Yes				
3	For R&D use														
4	Rainbow chart (vertical scanning direction, A4)										Yes				
5	Rainbow chart (horizontal scanning direction, A4)										Yes				
6	Color grid (A4)								Yes	Yes	Yes				
7	Rainbow chart (vertical scanning direction, LTR/LGL)										Yes				
8	Rainbow chart (horizontal scanning direction, LTR/LGL)										Yes				
9	Color grid (LTR/LGL)								Yes	Yes	Yes				
10	16 gradations	Yes	Yes			Yes		Yes							
11	17 gradations of Y/M/C/Bk/R/G/B	Yes													
12	Halftone			Yes	Yes	Yes	Yes	Yes							

PG TYPE	TYPE Pattern	Image check items														
		Gra- dation	Fog- ging	Trans- fer Fault	Black line (Color line)	White line	Un- even Den- sity	Un- even Den- sity at the Front/ Rea	Right Angle	Straig- ht Lines	Color dis- place- ment	Color	Ghost	Den- sity	White spots	
13	For checking ghost due to transfer failure													Yes		
14	For checking the density patch							Yes							Yes	
15	For checking transfer				Yes	Yes		Yes								
20	For R&D use															
21	For checking developing performance (white spots)	Yes														Yes
22	For checking resolution				Yes	Yes	Yes									
23	For checking banding image				Yes	Yes	Yes									
24	4 colors (landscape)			Yes	Yes	Yes		Yes								
25	4 colors (portrait)			Yes	Yes	Yes	Yes									
26	For calibrating color difference between the front and back sides with DADF (1-path model)															

Follow the procedure shown below to output the test print.

**1. Select the following service mode.**

TESTMODE > PRINT > PG-TYPE

**2. Enter the type number of the test print using the numeric keypad, and press the [Apply] key.**

**NOTE:**

If necessary, change the settings for test print in the following service mode.

If the settings are not changed, a test print will be executed with the initial values of service mode settings.

- Setting of the number of output sheets:  
TESTMODE > PRINT > COUNT
- Setting of 1-sided/2-sided printing:  
TESTMODE > PRINT > PHASE
- Setting of the image formation method:  
TESTMODE > PRINT > MODE
- Setting of the image correction table:  
TESTMODE > PRINT > THRU
- Setting of ON/OFF of the laser scanning interpolation process:  
TESTMODE > PRINT > NRKE
- Setting of ON/OFF of the test print interpolation process:  
TESTMODE > PRINT > BLND
- Setting of the paper source used when outputting a test print:  
TESTMODE > PRINT > FEED

**3. Execute the following service mode to output a test print.**

TESTMODE > PRINT > START

## ■ How to use the test print

### ● Color chart (TYPE=2)



Check item	Checking method	Assumed cause
Color	Check the color.	Cartridge error Soiling on the Color Displacement/Density Sensor ITB Unit error

### ● Rainbow chart (vertical scanning direction) (TYPE=4, TYPE=7)

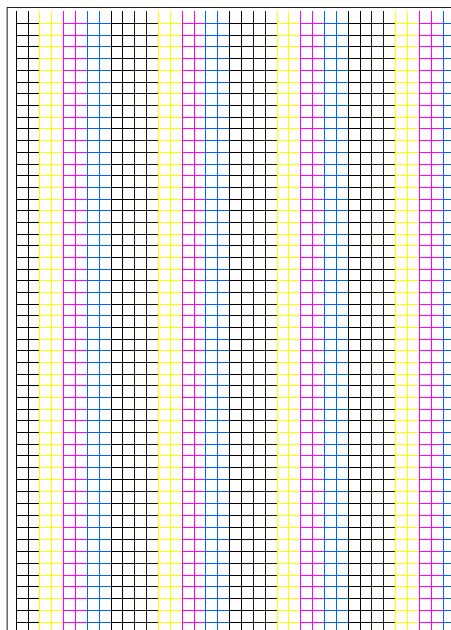

Check item	Checking method	Assumed cause
Color displacement	Output the PG after performing color displacement correction, and check the displacement for each color in the feed direction.	Soiling on the Color Displacement/Density Sensor Cartridge error ITB Unit error Main Drive Unit error

• **Rainbow chart (horizontal scanning direction) (TYPE=5, TYPE=8)**

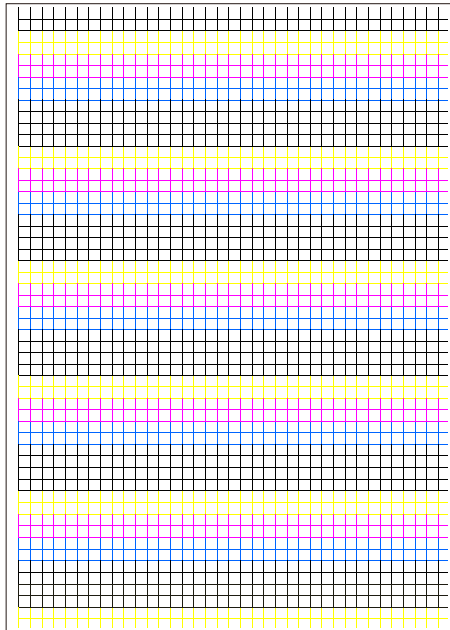

Check item	Checking method	Assumed cause
Color displacement	Output the PG after performing color displacement correction, and check the displacement for each color in the shaft direction.	Soiling on the Color Displacement/Density Sensor Cartridge error ITB Unit error Laser Scanner Unit error Main Controller PCB error

• **Color grid (TYPE=6, TYPE=9)**

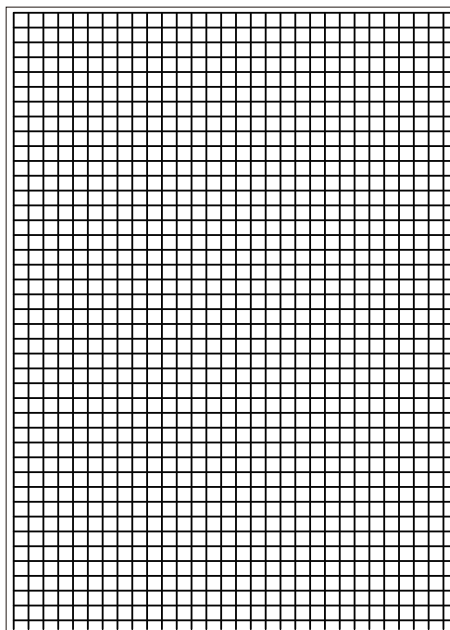

Check item	Checking method	Assumed cause
Color displacement	Check that there is no displacement between the lines of the respective colors.	Laser Scanner Unit error ITB Unit error Soiling on the Registration Sensor Secondary Transfer Roller error Main Drive Unit (drum rotation) error
Right angle accuracy and linearity	Check that there is nothing wrong with the right angle accuracy and linearity between the lines of the respective colors.	Laser Scanner Unit error Registration Roller error Secondary Transfer Roller error

• 16 gradations (TYPE=10)

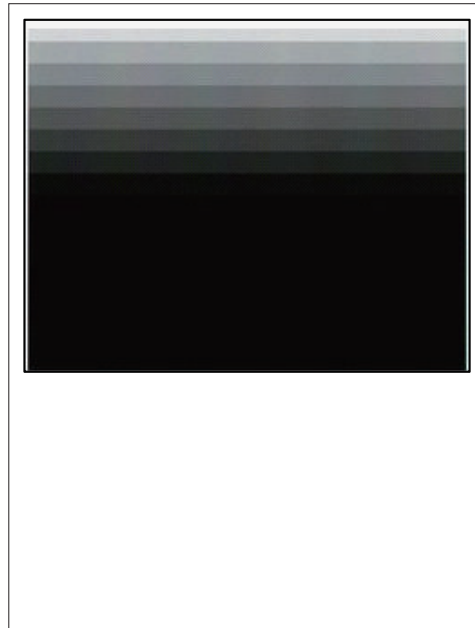

Check item	Checking method	Assumed cause
Gradation	Check that the 16 density gradations are recognizable.	Photosensitive Drum error Laser Scanner Unit error
Fogging	Check whether fogging appears only in the blank area.	Photosensitive Drum error Laser Scanner Unit error
White line	Check the entire image for any white line.	Photosensitive Drum error Laser Scanner Unit error
Uneven density between the front and rear	Check for any uneven density between the rear and front sides.	Photosensitive Drum error Laser Scanner Unit error Soiling on the laser light path

• 17 gradations of Y/M/C/Bk/R/G/B (TYPE=11)

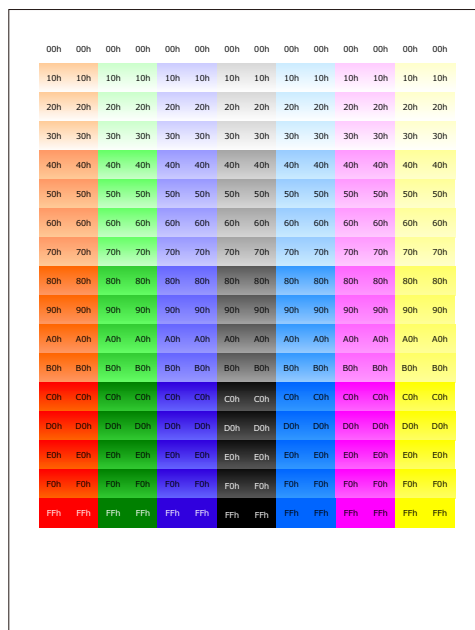

Check item	Checking method	Assumed cause
Gradation	Check that the 16 density gradations are recognizable.	Photosensitive Drum error Laser Scanner Unit error

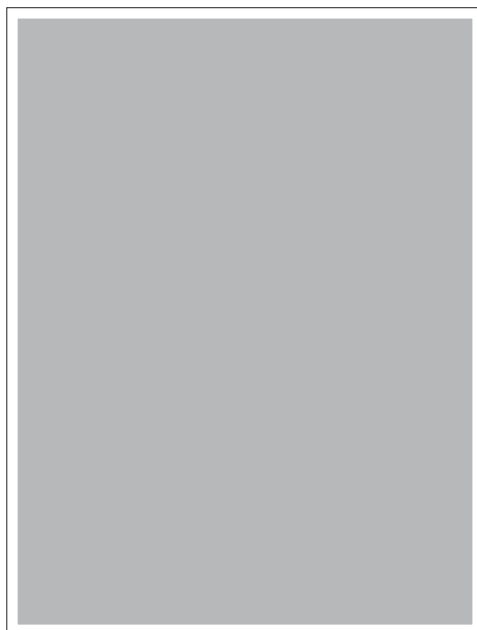

- Halftone (TYPE=12)

**NOTE:**

Various settings can be configured in the following service mode.

- Output of each developing color:  
TESTMODE > PRINT > SW-Y  
TESTMODE > PRINT > SW-M  
TESTMODE > PRINT > SW-C  
TESTMODE > PRINT > SW-K
- Print density setting:  
TESTMODE > PRINT > DENS-Y  
TESTMODE > PRINT > DENS-M  
TESTMODE > PRINT > DENS-C  
TESTMODE > PRINT > DENS-K

Check item	Checking method	Assumed cause
Transfer failure	Check the entire image for any transfer failure.	ITB error (scratches or soiling) Primary Transfer Pad error (scratches or soiling) Secondary Transfer Roller error (scratches or soiling)
Black line (colored line)	Check the entire image for any black line.	Scratches on the Photosensitive Drum
White line	Check the entire image for any white line.	ITB Unit error Secondary Transfer Roller error Soiling on the laser light path
Uneven density at regular intervals	Check the entire image for any uneven density at regular intervals.	Photosensitive Drum error
Uneven density	Check the entire image for any uneven density.	Soiling on the Dustproof Glas Deterioration of the ITB

- For checking ghost due to transfer failure (TYPE=13)

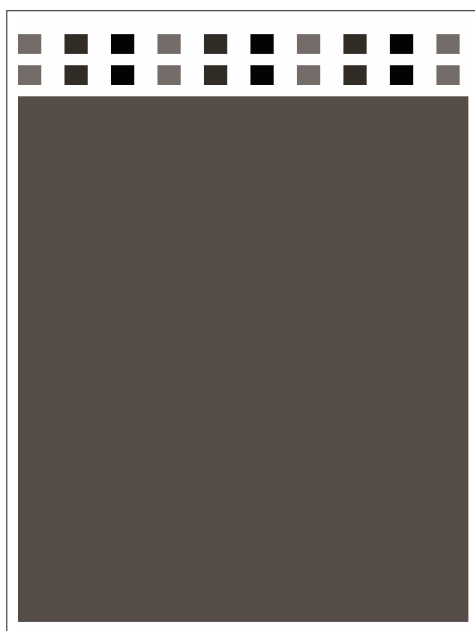

Check item	Checking method	Assumed cause
Ghost	Check the degree of ghosting (area where the density is too high or low) in halftone areas.	Cartridge error ITB Unit error

- For checking the density patch (TYPE=14)

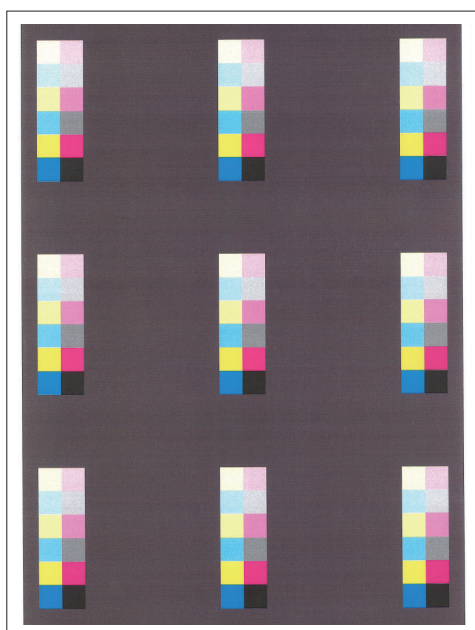

Check item	Checking method	Assumed cause
Density	Check the density of each patch after calibration.	Cartridge error ITB Unit error Secondary Transfer Roller error Soiling on the Color Displacement/Density Sensor
Uneven density	Check the difference in density among patches.	Cartridge error ITB Unit error

- For checking transfer (TYPE=15)

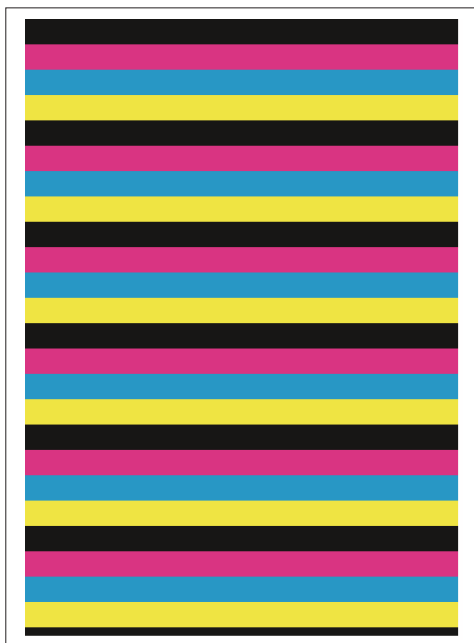

Check item	Checking method	Assumed cause
Uneven density	Check that there is no uneven density in the solid area of each color.	Laser Scanner Unit error Cartridge error Primary Transfer Pad error
Black line (colored line)	Check that there is no black line (colored line) in the solid area of each color.	Scratches on the Photosensitive Drum Soiling on the Primary Charging Roller
White line	Check that there is no white line in the solid area of each color.	ITB Unit error Secondary Transfer Roller error Soiling on the laser light path

- For checking developing performance (white spots) (TYPE=21)

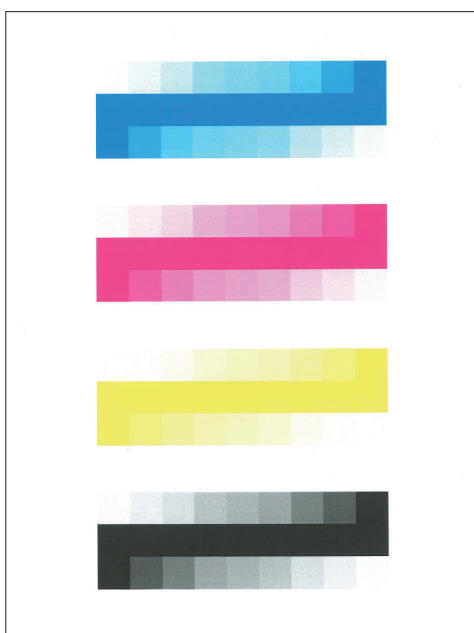

Check item	Checking method	Assumed cause
Gradation	Check the gradation performance.	Cartridge error Soiling on the Color Displacement/Density Sensor ITB Unit error

Check item	Checking method	Assumed cause
White spots	White spots near the solid patches in halftone patches just before and after the solid patches	Cartridge error

• For checking resolution (TYPE=22)

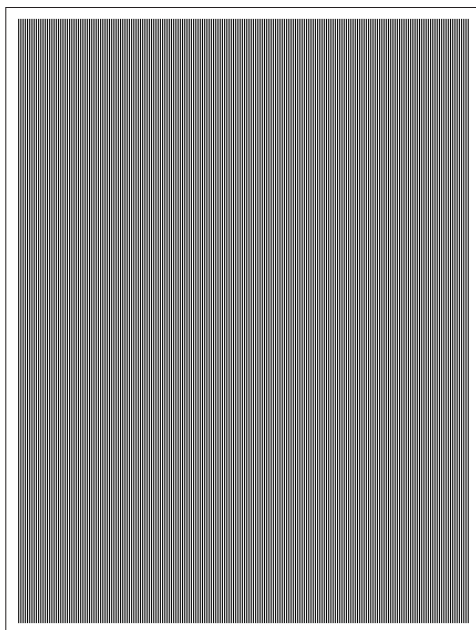

Check item	Checking method	Assumed cause
Line	Check the position and interval.	Laser Scanner Unit error Main Controller PCB error

• For checking banding image (TYPE=23)

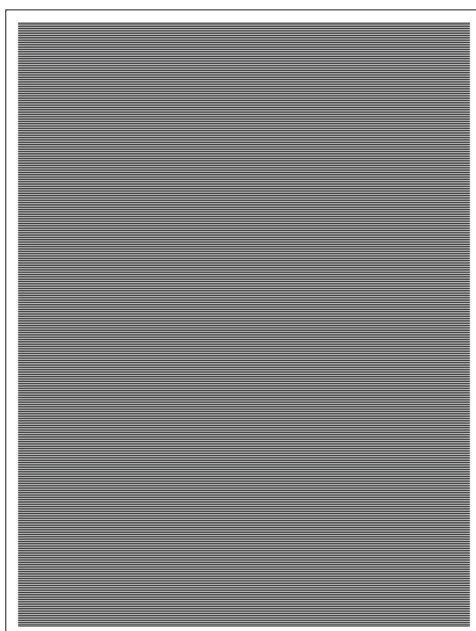

Check item	Checking method	Assumed cause
Line	Check the position and interval.	Cartridge error Main Drive Unit error ITB Unit error Fixing Assembly error Error in the feed path Paper slip at paper pickup

- 4 colors (landscape) (TYPE=24)

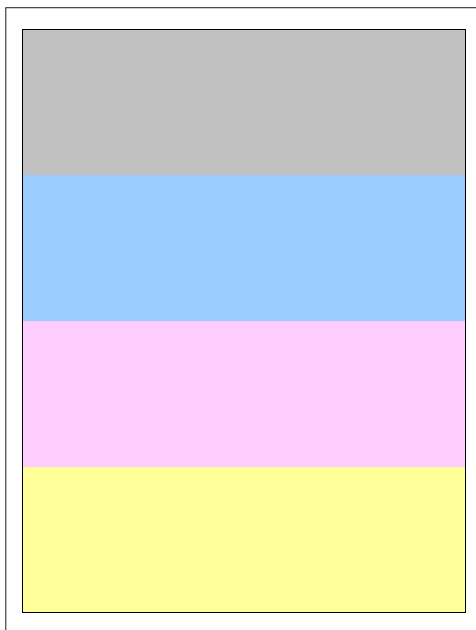

Check item	Checking method	Assumed cause
Line	Check the position of the line, and check whether the line occurs in all colors.	<p><b>If it occurs only in a single color:</b></p> <ul style="list-style-type: none"> <li>Cartridge error</li> <li>Laser Scanner Unit error</li> <li>ITB Unit error</li> </ul> <p><b>If it occurs in all colors:</b></p> <ul style="list-style-type: none"> <li>ITB Unit error</li> <li>Secondary Transfer Roller error</li> <li>Fixing Assembly error</li> </ul>

- 4 colors (portrait) (TYPE=25)

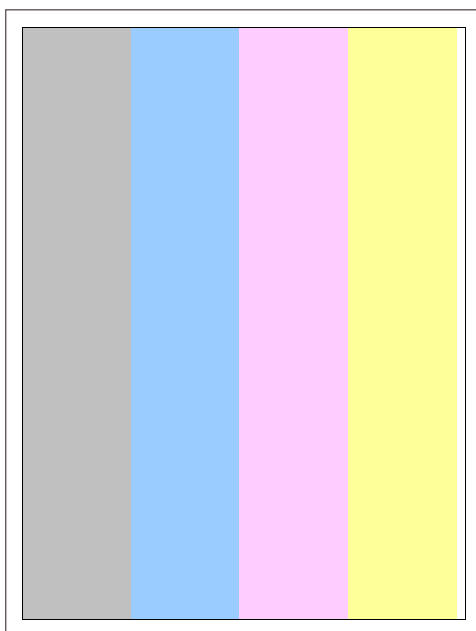

Check item	Checking method	Assumed cause
Line	Check the position of the line, and check whether the line occurs in all colors.	<b>If it occurs only in a single color:</b> Cartridge error Laser Scanner Unit error ITB Unit error  <b>If it occurs in all colors:</b> ITB Unit error Secondary Transfer Roller error Fixing Assembly error

## Cartridge Log Report

Logs such as history of cartridge replacement are output as a report.

There are two types of cartridge log reports; one for users and one for service technicians.

### CAUTION:

Do not provide users with the cartridge log report for service technicians because it contains detailed information that is not disclosed to end users.

```

08/25/2016 9:16PM LBP653C/654C                                0001
*****
*** CARTRIDGE LOG REPORT ***
*****
BODY No.                ABCD123456
Cyan
(1)
Serial No.  Type  Cpcty.  (4/6)          (S1/S5)  (5/7)  (S2/S6)  (S3/S7)  (S4/S8)
0100728959  C1   Large  08/25/2016 09:13 PM  00001763  0%    78%    80%    78%
08/25/2016 09:16 PM  00001764  0%    78%    80%    78%
Magenta
(1)
Serial No.  Type  Cpcty.  (4/6)          (S1/S5)  (5/7)  (S2/S6)  (S3/S7)  (S4/S8)
0100729012  C1   Starter 08/25/2016 09:13 PM  00001220  26%   25%    63%    25%
08/25/2016 09:16 PM  00001221  26%   25%    63%    25%
Yellow
(1)
Serial No.  Type  Cpcty.  (4/6)          (S1/S5)  (5/7)  (S2/S6)  (S3/S7)  (S4/S8)
0100729187  C1   Large  08/25/2016 09:13 PM  00001609  0%    80%    83%    82%
08/25/2016 09:16 PM  00001610  0%    80%    83%    82%
Black
(1)
Serial No.  Type  Cpcty.  (4/6)          (S1/S5)  (5/7)  (S2/S6)  (S3/S7)  (S4/S8)
0100729123  C1   Large  08/25/2016 09:13 PM  00000806  82%   83%    88%    83%
08/25/2016 09:16 PM  00000807  82%   83%    88%    83%
C4: 00000 0000000000
C5: 00000 0000000000
C6: 00000 0000000000
C7: 00000 0000000000
C8: 00000 0000000000

```

No.	Description
[1]	Replacement logs
[2]	Cartridge type: The number of times a non-genuine cartridge has been detected
[3]	Non-genuine cartridge page count

### NOTE:

In addition to output as a report, cartridge logs can also be displayed on the remote UI service mode screen (for service technicians) or remote UI screen (for users).

- To display cartridge logs (for service technicians):  
SERVICE REPORT > CRG-LOG
- To display cartridge logs (for users):  
Status Monitor/Cancel > Cartridge Log

### Output method

Execute the following service mode to output a cartridge log report for service technicians.

- To output a report on cartridge replacement history:  
COPIER > FUNCTION > MISC-P > CRG-LOG

**NOTE:**

- To output a cartridge log report (for users)  
Menu > Output Reports > Print List > Cartridge Log Report

**Replacement logs**

The record of replacement and usage of cartridges will be printed.

**CAUTION:**

Just after the cartridge has been replaced with a genuine cartridge or when a non-genuine cartridge is used, accurate information cannot be obtained and a random or approximate value may be printed. The remaining lives of some of the parts are not supported depending on the model.

Item	Description	Remarks
(1) Serial No.	Serial number of the cartridge	
(2) Type	Cartridge type	<ul style="list-style-type: none"> <li>C1: Genuine</li> <li>C2 to C8: Non-genuine</li> <li>C0: Unknown</li> </ul>
(3) Cpcty.	Cartridge capacity	Displayed in accordance with the toner fill-up amount
(4/6) First/Last Used	The date and time it was installed/last used	
(S1/S5) Pg. Count *	Cartridge page count (when it was installed/last used)	00000000 to 99999999
(5/7) Left	The amount remaining in the cartridge (when it was installed/last used)	0 to 100 % (New cartridge: 100%)
(S2/S6) Toner *	The remaining life of the toner (when it was installed/last used)	-128 to 100 % (New: 100%, Indefinite: -%)
(S3/S7) Drum *	The remaining life of the drum (when it was installed/last used)	-128 to 100 % (New: 100%, Indefinite: -%)
(S4/S8) Parts *	The remaining life of the Developing Assembly (when it was installed/last used)	-128 to 100 % (New: 100%, Indefinite: -%)

\*: S1 to S8 are printed only on reports for service technicians.

**Number of detections of non-genuine cartridge / Page count of non-genuine cartridge**

When a non-genuine cartridge is installed, it is classified as a cartridge type C2 to C8 according to the reason for judging it non-genuine, and the number of detections of each type and the number of pages printed with the cartridge installed are recorded.

Reason for judging it non-genuine	Cartridge type		Description
	Report for users*	Report for service	
OEM	C3	C5	The number of detections of an OEM cartridge, and the number of pages printed
Communication error	C2	C4	The number of detections of a cartridge without memory and the number of pages printed
Refill	C3	C6	The number of detections of a cartridge prepared by refilling toner into a genuine cartridge, and the number of pages printed
Copied memory	C3	C7	The number of detections of a cartridge prepared by refilling toner into a genuine cartridge and copying the contents of a normal memory, and the number of pages printed
Authentication failed	C2	C8	The number of detections of a cartridge that cannot be authenticated, and the number of pages printed

\*: Only C2 and C3 are displayed. The total count of the values of the reasons for judging the cartridge non-genuine is displayed.

## Troubleshooting Items

### Recurring faulty image

#### Overview

Foreign matters or lines on rollers along the paper feed path may cause faulty images in the vertical scanning direction.

#### Field Remedy

See the roller pitches listed in the tables below to clean and/or replace the corresponding parts.

#### CAUTION:

Since the Primary Charging Roller, Photosensitive Drum, and Developing Roller are located inside the cartridge and cannot be cleaned, replace the cartridge.

Roller pitch	Parts
Approx. 44 mm	Registration Roller
Approx. 50 mm	Secondary Transfer Roller
Approx. 19 mm	Primary Charging Roller
Approx. 63 mm	Photosensitive Drum
Approx. 31 mm	Developing Roller
Approx. 57 mm	Fixing Firm
Approx. 57 mm	Pressure Roller

### Confirming nip width

#### Overview

Although the nip width of the Fixing Assembly cannot be adjusted with this machine, it can be checked.

By checking the nip width when fixing failure occurs, it is possible to judge whether there is a problem with the Fixing Assembly.

#### Field Remedy

Check the nip width of the Fixing Assembly by the following procedure.

1. Print a solid black image on an A4/LTR size paper using the cartridge of this machine and bring it to the customer site.
2. Load the solid black printed paper with its printing side facing down in a cassette of the machine.
3. Use an external device to print a solid white image.
4. Open the Front Cover after approx. 25 seconds, leave it for 10 seconds or more, and then take out the printed paper.



5. Measure the widths of the glossy part of the toner on the printed paper, and check that they are within the range as follows.

- Center (a): 6.0 to 7.0 mm
- Edge (b) and (c): 6.0 to 7.0 mm each
- Difference between left and right ( $|b - c|$ ): 1.0 mm or less

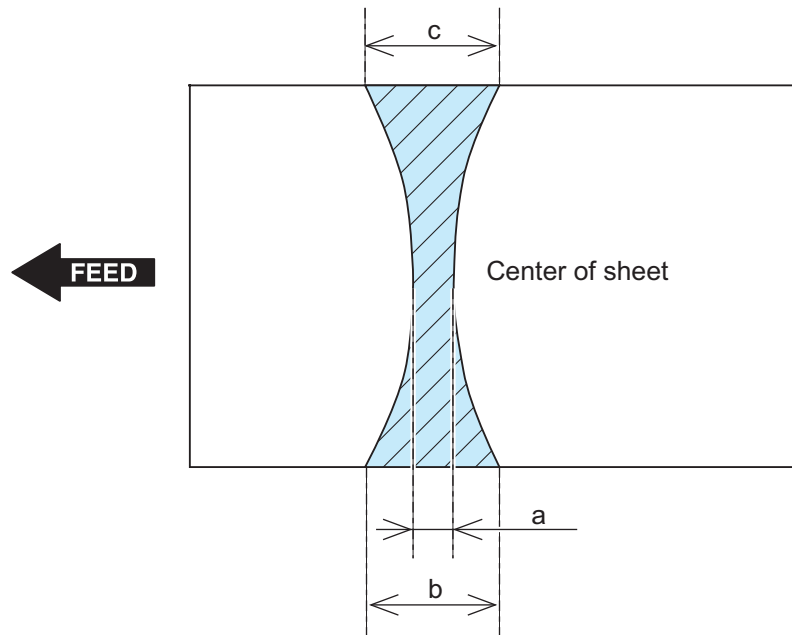

## Debug Log

### Function Overview

The debug log is a log that analyzes the program behavior of the machine to enable developers to identify problems. This machine is embedded with a function that compiles the log of the behavior of each software module as debug log and outputs it as integrated log for analyzing problems.

Be sure to collect the debug log when the Support Dept. of sales company so instructs.

Note that there is no need for service technicians to check the content of collected debug log.

#### Cases in which collection of debug log is effective

Collection of debug log is effective in the following cases:

- Neither the Support Dept. of sales company nor CINC can reproduce the trouble that occurred at the customer site
- When the error frequency is low
- When the failure is suspected to be due to firmware rather than a mechanical/electrical failure.

#### CAUTION:

If the procedure for reproducing the failure is clear and the Support Dept. of sales company and CINC can reproduce it, collection of debug log is not necessary.

### Conditions for collecting logs

#### Conditions for not being able to collect logs

In the following cases, the procedure for obtaining logs is not required because logs cannot be obtained.

- Service mode screen cannot be accessed
- The machine cannot recognize a USB flash drive
- No USB port is installed in the machine (when the model has only a copy function)

#### What is necessary to collect logs

A USB flash drive that satisfies the following conditions is required to obtain the debug logs of the machine:

- Formatted in FAT 16/FAT32
- There is a free space of approx. 100MB.
- Can be recognized by the machine

### Collection procedure

The following shows the procedure for collecting the debug log from the Control Panel.

1. **Connect a USB flash drive to the machine. In the case of a model having a USB connector on a side of the Control Panel, be sure to connect the USB flash drive to the Control Panel. In the case of a model having a USB connector only on the rear side, connect the USB flash drive to the USB connector on the rear side.**

#### CAUTION:

In the case of a model having a USB connector on the Control Panel, if the USB flash drive is connected to the USB connector on the rear side, debug logs are not transferred to the USB flash drive.

2. **Execute the following service mode from the Control Panel or Remote UI.**

- COPIER > FUNCTION > SYSTEM > LOGWRITE

"Executing..." is displayed while log collection is executed. When it is completed, the screen shows the service mode screen again.

3. **Execute the following service mode from the Control Panel or Remote UI.**

- COPIER > FUNCTION > SYSTEM > LOG2USB

"Executing..." is displayed while log collection is executed. When it is completed, the screen shows the service mode screen again.

**4. Remove the USB flash drive by the correct procedure.**

Connect the USB flash drive to the PC, and check that the log file shown below has been saved.

- Output by LOGWRITE: SUBLOG.TXT
- Output by LOG2USB: SUBLOG\_YYYYMMDD.HHMMSS\_XXX.gz (the file may be divided into multiple files)



# Error/Jam/Alarm

Overview.....	157
Error Code.....	160
Jam Code.....	166
Alarm Code.....	168

## Overview

This section describes the error codes that are displayed when failure has occurred.

Code type	Description	Reference
Error Code	This code is displayed when a failure caused by the host machine has occurred.	List of Error Codes
Jam code	This code is displayed when a jam has occurred.	List of Jam Codes
Alarm Code	This code is displayed when the machine's function has been partially lost.	List of Alarm Codes

## Error/Jam/Alarm Log indication

### Error log

Service Mode > COPIER > DISPLAY > ERR

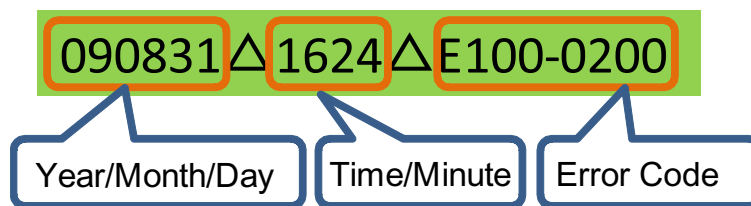

Indication example

```

ERR
090831 1624 E100-0200
-----
-----
-----
-----
-----

```

### Jam log

Service Mode > COPIER > DISPLAY > JAM

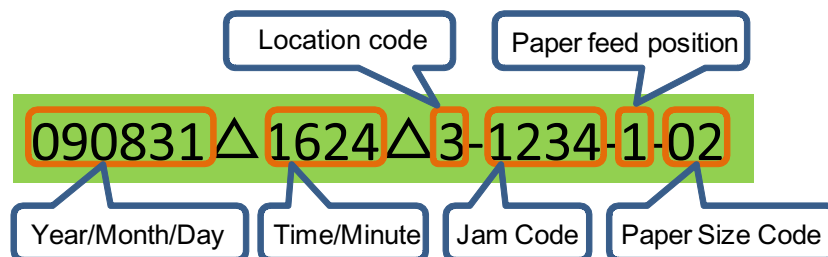

Indication example

```

JAM
090831 1624 3-1234-1-02
-----
-----
-----
-----
-----

```

### Alarm log

Service Mode > COPIER > DISPLAY > ALARM-2, ALARM-3

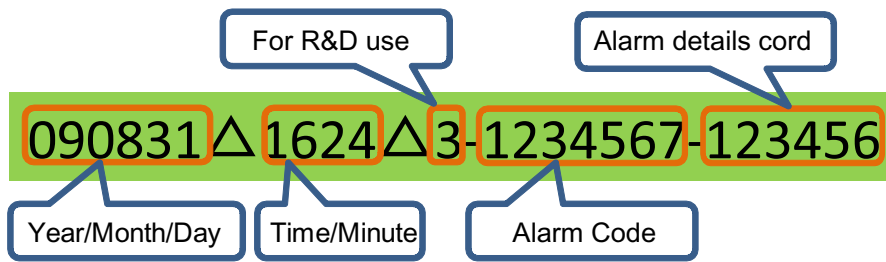

Indication example

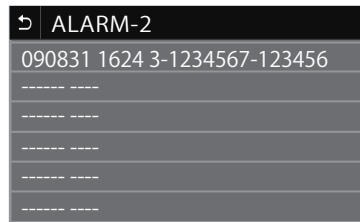

## JAM/ERR LOG REPORT

Output procedure of the JAM/ERR LOG REPORT

Service Mode > COPIER> FUNCTION> MISC-P > ERR-LOG

The explanation of mention contents

```

*****
***  JAM/ERR LOG REPORT  ***
*****
JAM
001  [1] 21/10 10:52 AM 10:53 AM [2] [3] [4] [5] [6] [7]
002  30/10 11:58 PM 11:58 PM 3 0 0B00 000022 1 00002
003  01/11 08:15 AM 08:15 AM 4 0 0049 000022 0 00000

ERROR
001  20/10 10:11 AM [8] [9] [10] [11]
002  25/10 07:35 AM 3 733 0000 000010
           3 004 0002 000018

ALARM2
001  31/10 12:04 AM [12] [13] [14] [15]
002  31/10 12:06 AM 3 090011 000000 000022

ALARM3
    
```

No.	Item
1	Day/Month Time/Minute
2	Location code
3	Not Used (for R&D)
4	Jam code
5	Total counter
6	Paper feed position
7	Paper size
8	Location code
9	Error code
10	Error details code
11	Total counter
12	Alarm level
13	Alarm code

No.	Item
14	Alarm details code
15	Total counter

## Location Code

The jam codes of this machine contain information on the location.

The location information is displayed in a single digit and has the meaning shown below:

Device	Location code
Host machine	3

## Pickup Position Code

When a jam occurs, the pickup location is indicated with the following pickup position code.

Pickup position	Pickup position code
Pickup from Multi-purpose Tray	0
Cassette 1	1
Option cassette	2
At duplex printing	7

## Error Code

### Error Code Details

<b>E000-0000---</b>	<b>Error in temperature rising of Fixing Assembly</b>
<b>Detection Description</b>	Temperature of the Fixing Assembly did not reach a certain temperature within the specified period of time.
<b>Remedy</b>	<ol style="list-style-type: none"> <li>1. Check the connector connection between the Fixing Assembly and the Engine Controller PCB.</li> <li>2. Replace the Fixing Assembly.</li> <li>3. Replace the Engine Controller PCB.</li> </ol>
<b>E001-0000---</b>	<b>Abnormal high temperature of Fixing Assembly</b>
<b>Detection Description</b>	It was detected that the temperature of the Fixing Assembly was abnormally high.
<b>Remedy</b>	<ol style="list-style-type: none"> <li>1. Check the connector connection between the Fixing Assembly and the Engine Controller PCB.</li> <li>2. Replace the Fixing Assembly.</li> <li>3. Replace the Engine Controller PCB.</li> </ol>
<b>E001-0001---</b>	<b>Abnormal high temperature of Fixing Assembly</b>
<b>Detection Description</b>	It was detected that the temperature of the Fixing Assembly (Sub Thermistor) was abnormally high.
<b>Remedy</b>	<ol style="list-style-type: none"> <li>1. Check the connector connection between the Fixing Assembly and the Engine Controller PCB.</li> <li>2. Replace the Fixing Assembly.</li> <li>3. Replace the Engine Controller PCB.</li> </ol>
<b>E003-0000---</b>	<b>Abnormal low temperature of Fixing Assembly</b>
<b>Detection Description</b>	It was detected that the temperature of the Fixing Assembly was abnormally low.
<b>Remedy</b>	<ol style="list-style-type: none"> <li>1. Check the connector connection between the Fixing Assembly and the Engine Controller PCB.</li> <li>2. Replace the Fixing Assembly.</li> <li>3. Replace the Engine Controller PCB.</li> </ol>
<b>E003-0001---</b>	<b>It was detected that the temperature of the Fixing Assembly (Sub Thermistor) was abnormally low.</b>
<b>Detection Description</b>	It was detected that the temperature of the Fixing Assembly (Sub Thermistor) was abnormally low.
<b>Remedy</b>	<ol style="list-style-type: none"> <li>1. Check the connector connection between the Fixing Assembly and the Engine Controller PCB.</li> <li>2. Replace the Fixing Assembly.</li> <li>3. Replace the Engine Controller PCB.</li> </ol>
<b>E004-0000---</b>	<b>Error in fixing power supply drive circuit</b>
<b>Detection Description</b>	The zero cross signal was not detected for the specified period of time or more.
<b>Remedy</b>	<ol style="list-style-type: none"> <li>1. Check the connector connection between the Fixing Assembly and the Engine Controller PCB.</li> <li>2. Replace the Fixing Assembly.</li> <li>3. Replace the Engine Controller PCB.</li> </ol>
<b>E012-0000---</b>	<b>Black Drum Motor error</b>
<b>Detection Description</b>	An error in the initial operation of the Drum Motor was detected.
<b>Remedy</b>	<ol style="list-style-type: none"> <li>1. Reconnect the connector of the Main Motor.</li> <li>2. Replace the Engine Controller PCB.</li> </ol>
<b>E012-0001---</b>	<b>Black Drum Motor error</b>
<b>Detection Description</b>	Rotation error of the Drum Motor was detected.
<b>Remedy</b>	<ol style="list-style-type: none"> <li>1. Reconnect the connector of the Main Motor.</li> <li>2. Replace the Engine Controller PCB.</li> </ol>
<b>E014-0000---</b>	<b>Error in startup of the Main Motor</b>
<b>Detection Description</b>	Revolution of the Main Motor did not reach the specified value.
<b>Remedy</b>	<ol style="list-style-type: none"> <li>1. Check the connector connection between the Main Motor and the Engine Controller PCB.</li> <li>2. Replace the Main Motor.</li> <li>3. Replace the Engine Controller PCB.</li> </ol>



<b>E014-0001---</b>	<b>Error in startup of the Main Motor</b>
<b>Detection Description</b>	Revolution of the Main Motor was out of the specified range.
<b>Remedy</b>	<ol style="list-style-type: none"> <li>1. Check the connector connection between the Main Motor and the Engine Controller PCB.</li> <li>2. Replace the Main Motor.</li> <li>3. Replace the Engine Controller PCB.</li> </ol>
<b>E015-0000---</b>	<b>Error in Developing Disengagement Motor</b>
<b>Detection Description</b>	The engine detected an error in the Developing Disengagement Motor.
<b>Remedy</b>	<ol style="list-style-type: none"> <li>1. Check the harnesses/connectors connecting the Developing Disengagement Switch, the Developing Disengagement Solenoid and the Engine Controller PCB.</li> <li>2. Check that the Developing Disengagement Switch is properly installed.</li> <li>3. Replace the Developing Disengagement Switch.</li> <li>4. Replace the Developing Disengagement Solenoid.</li> <li>5. Replace the Engine Controller PCB.</li> </ol>
<b>E015-0001---</b>	<b>Cassette 1 lift-up error</b>
<b>Detection Description</b>	After lift-up of the Lifting Plate of the cassette of the host machine started, ON status of the Lifter Sensor of the cassette of the host machine was not detected within the specified period of time.
<b>Remedy</b>	<ol style="list-style-type: none"> <li>1. While the cassette of the host machine is removed, turn ON the power and insert the cassette, then check the operation sound of the motor. When there is operation sound of the motor, check if the Lifting Plate has been lifted up. When the Lifting Plate has been lifted up: <ol style="list-style-type: none"> <li>1-1. Check that the Lifter Sensor of the cassette of the host machine is properly installed.</li> <li>1-2. Check the harness/connector between the Engine Controller PCB and the Lifter Sensor.</li> <li>1-3. Replace the Lifter Sensor. 1-4. Replace the Engine Controller PCB.</li> </ol> When the Lifting Plate has not been lifted up: <ol style="list-style-type: none"> <li>2-1. Check the condition of the gear at the host machine side (missing teeth, swing).</li> <li>2-2. Check the harness/connector between the Engine Controller PCB and the Lifter Solenoid of the cassette of the host machine.</li> <li>2-3. Replace the Lifter Solenoid.</li> <li>2-4. Replace the Pickup Motor of the cassette of the host machine.</li> <li>2-5. Replace the Driver PCB.</li> <li>2-6. Replace the Engine Controller PCB.</li> </ol> When there is no operation sound of the motor, check the followings: <ol style="list-style-type: none"> <li>3-1. Check the harness/connector between the Engine Controller PCB and the Pickup Motor of the cassette of the host machine.</li> <li>3-2. Check the condition of the gear at the host machine side (missing teeth, swing).</li> <li>3-3. Check the Pickup Motor.</li> <li>3-4. Replace the Driver PCB.</li> <li>3-5. Replace the Engine Controller PCB.</li> </ol> </li> </ol>

<b>E015-0002---</b>	<b>Cassette 2 lift-up error</b>
<b>Detection Description</b>	After lift-up of the Lifting Plate of the 1-Cassette Unit started, ON status of the Lifter Sensor of the 1-Cassette Unit was not detected within the specified period of time.
<b>Remedy</b>	<p>1. While the cassette of the 1-Cassette Unit is removed, turn ON the power and insert the cassette, then check the operation sound of the motor.</p> <p>When there is operation sound of the motor, check if the Lifting Plate has been lifted up.</p> <p>When the Lifting Plate has been lifted up:</p> <p>1-1. Check that the Lifter Sensor of the Cassette Unit is properly installed.</p> <p>1-2. Check the harness/connector between the Engine Controller PCB and the Lifter Sensor.</p> <p>1-3. Replace the Lifter Sensor.</p> <p>1-4. Replace the Cassette Feeder Driver PCB.</p> <p>1-5. Replace the Engine Controller PCB.</p> <p>When the Lifting Plate has not been lifted up:</p> <p>2-1. Check the condition of the gear of the Cassette Unit (missing teeth, swing).</p> <p>2-2. Check the harness/connector between the Engine Controller PCB and the Lifter Solenoid of the Cassette Unit.</p> <p>2-3. Replace the Lifter Solenoid.</p> <p>2-4. Replace the Pickup Motor of the Cassette Unit.</p> <p>2-5. Replace the Cassette Feeder Driver PCB.</p> <p>2-6. Replace the Engine Controller PCB.</p> <p>When there is no operation sound of the motor, check the followings:</p> <p>3-1. Check the harness/connector between the Engine Controller PCB and the Pickup Motor of the Cassette Unit.</p> <p>3-2. Check the condition of the gear at the Cassette Unit side (missing teeth, swing).</p> <p>3-3. Replace the Pickup Motor.</p> <p>3-4. Replace the Cassette Feeder Driver PCB.</p> <p>3-5. Replace the Engine Controller PCB.</p>
<b>E020-0000---</b>	<b>Density Sensor error</b>
<b>Detection Description</b>	An error in the Density Sensor was detected.
<b>Remedy</b>	<p>1. Check the remaining toner level.</p> <p>2. Replace the Toner Cartridge.</p> <p>3. Check the harness/connector between the Color Displacement/Density Sensor and the Engine Controller PCB.</p> <p>4. Replace the Color Displacement/Density Sensor.</p> <p>5. Replace the ITB.</p> <p>6. Replace the Engine Controller PCB.</p>
<b>E021-1000---</b>	<b>Yellow Developing Motor rotation error</b>
<b>Detection Description</b>	It was judged that the Developing Motor did not rotate.
<b>Remedy</b>	<p>1. Check the harness/connector between the Developing Motor and the Engine Controller PCB.</p> <p>2. Replace the Developing Motor.</p> <p>3. Replace the Driver PCB.</p> <p>4. Replace the Engine Controller PCB.</p>
<b>E021-1001---</b>	<b>Magenta Developing Motor rotation error</b>
<b>Detection Description</b>	It was judged that the Developing Motor did not rotate.
<b>Remedy</b>	<p>1. Check the harness/connector between the Developing Motor and the Engine Controller PCB.</p> <p>2. Replace the Developing Motor.</p> <p>3. Replace the Driver PCB.</p> <p>4. Replace the Engine Controller PCB.</p>
<b>E021-1002---</b>	<b>Cyan Developing Motor rotation error</b>
<b>Detection Description</b>	It was judged that the Developing Motor did not rotate.
<b>Remedy</b>	<p>1. Check the harness/connector between the Developing Motor and the Engine Controller PCB.</p> <p>2. Replace the Developing Motor.</p> <p>3. Replace the Driver PCB.</p> <p>4. Replace the Engine Controller PCB.</p>

<b>E021-1003---</b>	<b>Black Developing Motor rotation error</b>
<b>Detection Description</b>	It was judged that the Developing Motor did not rotate.
<b>Remedy</b>	<ol style="list-style-type: none"> <li>1. Check the harness/connector between the Developing Motor and the Engine Controller PCB.</li> <li>2. Replace the Developing Motor.</li> <li>3. Replace the Driver PCB.</li> <li>4. Replace the Engine Controller PCB.</li> </ol>
<b>E021-2000---</b>	<b>Error in startup of the Yellow Developing Motor</b>
<b>Detection Description</b>	Revolution of the Developing Motor did not reach the specified value.
<b>Remedy</b>	<ol style="list-style-type: none"> <li>1. Check the harness/connector between the Developing Motor and the Engine Controller PCB.</li> <li>2. Replace the Developing Motor.</li> <li>3. Replace the Driver PCB.</li> <li>4. Replace the Engine Controller PCB.</li> </ol>
<b>E021-2001---</b>	<b>Error in startup of the Magenta Developing Motor</b>
<b>Detection Description</b>	Revolution of the Developing Motor did not reach the specified value.
<b>Remedy</b>	<ol style="list-style-type: none"> <li>1. Check the harness/connector between the Developing Motor and the Engine Controller PCB.</li> <li>2. Replace the Developing Motor.</li> <li>3. Replace the Driver PCB.</li> <li>4. Replace the Engine Controller PCB.</li> </ol>
<b>E021-2002---</b>	<b>Error in startup of the Cyan Developing Motor</b>
<b>Detection Description</b>	Revolution of the Developing Motor did not reach the specified value.
<b>Remedy</b>	<ol style="list-style-type: none"> <li>1. Check the harness/connector between the Developing Motor and the Engine Controller PCB.</li> <li>2. Replace the Developing Motor.</li> <li>3. Replace the Driver PCB.</li> <li>4. Replace the Engine Controller PCB.</li> </ol>
<b>E021-2003---</b>	<b>Error in startup of the Black Developing Motor</b>
<b>Detection Description</b>	Revolution of the Developing Motor did not reach the specified value.
<b>Remedy</b>	<ol style="list-style-type: none"> <li>1. Check the harness/connector between the Developing Motor and the Engine Controller PCB.</li> <li>2. Replace the Developing Motor.</li> <li>3. Replace the Driver PCB.</li> <li>4. Replace the Engine Controller PCB.</li> </ol>
<b>E052-0000---</b>	<b>Duplex Feed Unit absent error</b>
<b>Detection Description</b>	Connection of the Duplex Feed Unit was not correct.
<b>Remedy</b>	<ol style="list-style-type: none"> <li>1. Reinstall the Duplex Feed Unit.</li> </ol>
<b>E066-0000---</b>	<b>Environment Sensor error</b>
<b>Detection Description</b>	An error in the Environment Sensor was detected.
<b>Remedy</b>	<ol style="list-style-type: none"> <li>1. Check the harness/connection of the Environment Sensor and the Engine Controller PCB.</li> <li>2. Replace the Environment Sensor.</li> <li>3. Replace the Engine Controller PCB.</li> </ol>
<b>E078-0000---</b>	<b>Primary transfer disengagement mechanism error</b>
<b>Detection Description</b>	Primary transfer disengagement mechanism did not work properly.
<b>Remedy</b>	<ol style="list-style-type: none"> <li>1. Check the harnesses/connectors connecting the Primary Transfer Disengagement Switch, the Primary Transfer Disengagement Solenoid and the Engine Controller PCB.</li> <li>2. Replace the Primary Transfer Disengagement Switch.</li> <li>3. Replace the Primary Transfer Disengagement Solenoid.</li> <li>4. Replace the Engine Controller PCB.</li> </ol>
<b>E100-0000---</b>	<b>Yellow scanner area failure</b>
<b>Detection Description</b>	Error in the Scanner Motor, Laser Unit, or BD detection in the yellow scanner area
<b>Remedy</b>	<ol style="list-style-type: none"> <li>1. Check the harness/FFC/connector between the Laser Unit and the Engine Controller PCB.</li> <li>2. Replace the FFC.</li> <li>3. Replace the Laser Unit.</li> <li>4. Replace the Engine Controller PCB.</li> </ol>

<b>E100-0001---</b>	<b>Magenta scanner area failure</b>
<b>Detection Description</b>	Error in the Scanner Motor, Laser Unit, or BD detection in the magenta scanner area
<b>Remedy</b>	<ol style="list-style-type: none"> <li>1. Check the harness/FFC/connector between the Laser Unit and the Engine Controller PCB.</li> <li>2. Replace the FFC.</li> <li>3. Replace the Laser Unit.</li> <li>4. Replace the Engine Controller PCB.</li> </ol>
<b>E100-0002---</b>	<b>Cyan scanner area failure</b>
<b>Detection Description</b>	Error in the Scanner Motor, Laser Unit, or BD detection in the cyan scanner area
<b>Remedy</b>	<ol style="list-style-type: none"> <li>1. Check the harness/FFC/connector between the Laser Unit and the Engine Controller PCB.</li> <li>2. Replace the FFC.</li> <li>3. Replace the Laser Unit.</li> <li>4. Replace the Engine Controller PCB.</li> </ol>
<b>E100-0003---</b>	<b>Black scanner area failure</b>
<b>Detection Description</b>	Error in the Scanner Motor, Laser Unit, or BD detection in the black scanner area
<b>Remedy</b>	<ol style="list-style-type: none"> <li>1. Check the harness/FFC/connector between the Laser Unit and the Engine Controller PCB.</li> <li>2. Replace the FFC.</li> <li>3. Replace the Laser Unit.</li> <li>4. Replace the Engine Controller PCB.</li> </ol>
<b>E110-0000---</b>	<b>Primary pseudo BD correction error</b>
<b>Detection Description</b>	The scanner failed to be Ready within 3 seconds after start of pseudo BD control.
<b>Remedy</b>	<ol style="list-style-type: none"> <li>1. Check that the engine test print is properly printed.</li> <li>2. Check the FFC between the Main Controller PCB and the Engine Controller PCB.</li> <li>3. Replace the Main Controller PCB.</li> </ol>
<b>E194-0000---</b>	<b>CPR Sensor error</b>
<b>Detection Description</b>	An error in the CPR Sensor was detected.
<b>Remedy</b>	<ol style="list-style-type: none"> <li>1. Replace the Toner Cartridge.</li> <li>2. Check the harness/connector between the Color Displacement/Density Sensor and the Engine Controller PCB.</li> <li>3. Replace the Color Displacement/Density Sensor Unit.</li> <li>4. Replace the Engine Controller PCB.</li> <li>5. Replace the ITB Unit.</li> </ol>
<b>E196-0000---</b>	<b>Engine Controller error</b>
<b>Detection Description</b>	Update of the Engine Controller was failed. (RFU mode right after the startup)
<b>Remedy</b>	<ol style="list-style-type: none"> <li>1. Replace the Engine Controller PCB.</li> </ol>
<b>E198-0000---</b>	<b>Engine Controller memory failure</b>
<b>Detection Description</b>	Error in the nonvolatile memory on the Engine Controller PCB
<b>Remedy</b>	<ol style="list-style-type: none"> <li>1. Turn OFF and then ON the power and check if the symptom occurs again.</li> <li>2. Replace the Engine Controller PCB.</li> </ol>
<b>E246-0000---</b>	<b>System error</b>
<b>Detection Description</b>	System error
<b>Remedy</b>	Contact the sales company.
<b>E247-0000---</b>	<b>System error</b>
<b>Detection Description</b>	System error
<b>Remedy</b>	Contact the sales company.
<b>E350-0000---</b>	<b>System error</b>
<b>Detection Description</b>	System error
<b>Remedy</b>	Contact the sales company.

<b>E354-0000---</b>	<b>System error</b>
<b>Detection Description</b>	System error
<b>Remedy</b>	Contact the sales company.
<b>E355-0000---</b>	<b>System error</b>
<b>Detection Description</b>	System error
<b>Remedy</b>	Contact the sales company.
<b>E355-0004---</b>	<b>System error</b>
<b>Detection Description</b>	System error
<b>Remedy</b>	Contact the sales company.
<b>E355-0005---</b>	<b>System error</b>
<b>Detection Description</b>	System error
<b>Remedy</b>	Contact the sales company.
<b>E733-0000---</b>	<b>Printer communication error</b>
<b>Detection Description</b>	Communication error between the Engine Controller PCB and the Main Controller PCB occurred.
<b>Remedy</b>	<ol style="list-style-type: none"> <li>1. Check the connector connection between the Engine Controller PCB and the Main Controller PCB.</li> <li>2. Install the set of the controller firmware.</li> <li>3. Replace the Main Controller PCB.</li> <li>4. Replace the Engine Controller PCB.</li> </ol>
<b>E743-0000---</b>	<b>DDI communication error</b>
<b>Detection Description</b>	Software sequence error
<b>Remedy</b>	1. Turn OFF and then ON the main power.
<b>E805-0005---</b>	<b>Sub Fan error</b>
<b>Detection Description</b>	The Sub Fan was locked for a specified consecutive period of time.
<b>Remedy</b>	<ol style="list-style-type: none"> <li>1. Check the connection of the Sub Fan.</li> <li>2. Replace the Sub Fan.</li> </ol>
<b>E806-0000---</b>	<b>Main Fan error</b>
<b>Detection Description</b>	The Main Fan was locked for a specified consecutive period of time.
<b>Remedy</b>	<ol style="list-style-type: none"> <li>1. Check the connection of the Main Fan.</li> <li>2. Replace the Main Fan.</li> </ol>
<b>E808-0000---</b>	<b>Low-voltage power supply failure detection</b>
<b>Detection Description</b>	Printer detected low-voltage power supply failure.
<b>Remedy</b>	1. Replace the Engine Controller PCB
<b>E840-0000---</b>	<b>Pressure release mechanism error</b>
<b>Detection Description</b>	An error in pressure release mechanism of the Fixing Assembly was detected.
<b>Remedy</b>	<ol style="list-style-type: none"> <li>1. Replace the Fixing Assembly.</li> <li>2. Replace the Fixing Motor.</li> </ol>

## Jam Code

### Jam Code Details

#### ■ Host machine

- ▶ Simplex paper path
- ⋯▶ Duplex paper path

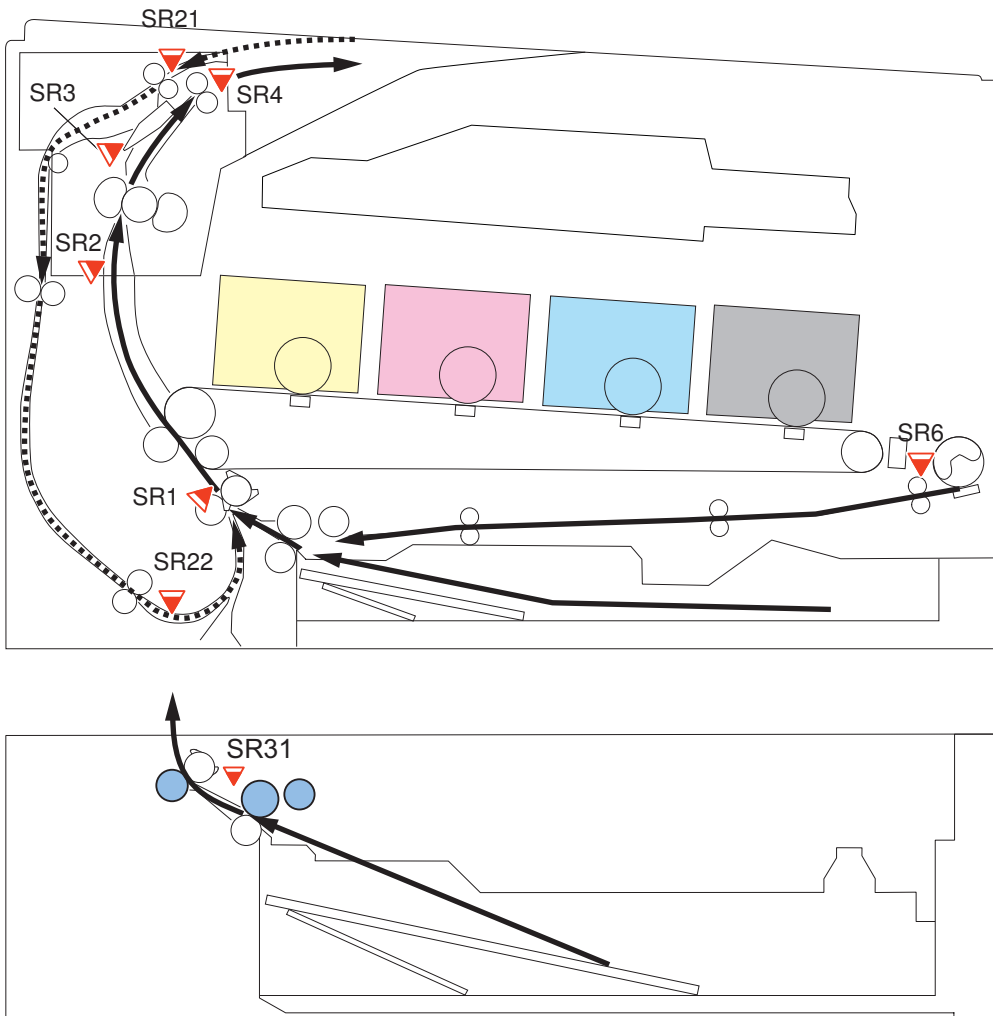

Jam Code	Type	Sensor Name	Sensor ID	Area
0104	Pickup Delay Jam 1	Registration sensor/Multi-purpose Tray Paper Sensor/Cassette Feed Sensor	SR1/SR6/SR31	Cassette1/Multi-purpose Tray/Cassette2
0105	Pickup Delay Jam 2	Cassette Feed Sensor	SR31	Cassette2
014C	Fixing Delivery Delay Jam1	Registration sensor/Fixing Delivery Sensor/Delivery Sensor	SR1/SR3/SR4	Cartridge to Fixing Roller Area
016C	Delivery Delay Jam1	Registration sensor/Fixing Delivery Sensor/Delivery Sensor	SR1/SR3/SR4	Fixing Roller to Delivery Area
0248	Pickup Stationary Jam 1	Registration sensor/Fixing Delivery Sensor/Delivery Sensor	SR1/SR3/SR4	Registration Area to Cartridge Cartridge to Fixing Roller Area
0250	Fixing Delivery Stationary Jam 1	Registration sensor/Fixing Delivery Sensor/Delivery Sensor	SR1/SR3/SR4	Fixing Roller to Delivery Area

Jam Code	Type	Sensor Name	Sensor ID	Area
025C	Wrap Jam1	Registration sensor/Fixing Delivery Sensor/Delivery Sensor	SR1/SR3/SR4	Cartridge to Fixing Roller Area Fixing Roller to Delivery Area
025D	Wrap Jam2	Registration sensor/Fixing Delivery Sensor/Delivery Sensor/Duplex Re-pickup Sensor	SR1/SR3/SR4/SR22	Cartridge to Fixing Roller Area Fixing Roller to Delivery Area
0260	Reverse Area Jam1	Registration sensor/Fixing Delivery Sensor/Delivery Sensor/Duplex Re-pickup Sensor	SR1/SR3/SR4/SR22	Fixing Roller to Delivery Area
0270	Delivery Stationary Jam 1	Registration sensor/Fixing Delivery Sensor/Delivery Sensor	SR1/SR3/SR4	Fixing Roller to Delivery Area
029D	Wrap Jam2	Registration sensor/Fixing Delivery Sensor/Delivery Sensor/Duplex Re-pickup Sensor	SR1/SR3/SR4/SR22	Duplex Re-pickup Assembly
02A0	Reverse Area Jam1	Registration sensor/Fixing Delivery Sensor/Delivery Sensor/Duplex Re-pickup Sensor	SR1/SR3/SR4/SR22	Duplex Re-pickup Assembly
02A4	Duplex Re-pickup Assembly Jam1	Duplex Re-pickup Sensor	SR22	Duplex Re-pickup Assembly
02A5	Duplex Re-pickup Assembly Jam2	Duplex Re-pickup Sensor	SR22	Duplex Re-pickup Assembly
02CD	Wrap Jam2	Registration sensor/Fixing Delivery Sensor/Delivery Sensor/Duplex Re-pickup Sensor	SR1/SR3/SR4/SR22	Registration Area to Delivery Area Duplex Re-pickup Assembly
02E0	Reverse Area Jam1	Registration sensor/Fixing Delivery Sensor/Delivery Sensor/Duplex Re-pickup Sensor	SR1/SR3/SR4/SR22	Registration Area to Delivery Area Duplex Re-pickup Assembly
1014	Power ON Jam 1	Cassette Feed Sensor	SR31	Cassette2
1054	Power ON Jam 1	Registration sensor/Fixing Delivery Sensor/Delivery Sensor/Duplex Re-pickup Sensor	SR1/SR3/SR4/SR22	Registration Area to Delivery Area
1094	Power ON Jam 1	Registration sensor/Fixing Delivery Sensor/Delivery Sensor/Duplex Re-pickup Sensor	SR1/SR3/SR4/SR22	Duplex Re-pickup Assembly
10D4	Power ON Jam 1	Registration sensor/Fixing Delivery Sensor/Delivery Sensor/Duplex Re-pickup Sensor	SR1/SR3/SR4/SR22	Registration Area to Delivery Area Duplex Re-pickup Assembly
1017	Power ON Jam 4	Cassette Feed Sensor	SR31	Cassette2
1057	Power ON Jam 4	Registration sensor/Fixing Delivery Sensor/Delivery Sensor/Duplex Re-pickup Sensor	SR1/SR3/SR4/SR22	Registration Area to Delivery Area
1097	Power ON Jam 4	Registration sensor/Fixing Delivery Sensor/Delivery Sensor/Duplex Re-pickup Sensor	SR1/SR3/SR4/SR22	Duplex Re-pickup Assembly
10D7	Power ON Jam 4	Registration sensor/Fixing Delivery Sensor/Delivery Sensor/Duplex Re-pickup Sensor	SR1/SR3/SR4/SR22	Registration Area to Delivery Area Duplex Re-pickup Assembly
1118	Door Open Jam1	Registration sensor/Multi-purpose Tray Paper Sensor/Cassette Feed Sensor	SR1/SR6/SR31	Cassette1/Multi-purpose Tray/Cassette2
1158	Door Open Jam1	Registration sensor/Fixing Delivery Sensor/Delivery Sensor/Duplex Re-pickup Sensor	SR1/SR3/SR4/SR22	Registration Area to Delivery Area
1198	Door Open Jam1	Registration sensor/Fixing Delivery Sensor/Delivery Sensor/Duplex Re-pickup Sensor	SR1/SR3/SR4/SR22	Duplex Re-pickup Assembly
11D8	Door Open Jam1	Registration sensor/Fixing Delivery Sensor/Delivery Sensor/Duplex Re-pickup Sensor	SR1/SR3/SR4/SR22	Registration Area to Delivery Area Duplex Re-pickup Assembly

## Alarm Code

### Alarm Code Details

<b>10-0401</b>	<b>Toner Bottle empty alarm (Y)</b>
<b>A. Operation / B. Cause / C. Remedy</b>	When the Toner Bottle empty was detected

<b>10-0402</b>	<b>Toner Bottle empty alarm (M)</b>
<b>A. Operation / B. Cause / C. Remedy</b>	When the Toner Bottle empty was detected

<b>10-0403</b>	<b>Toner Bottle empty alarm (C)</b>
<b>A. Operation / B. Cause / C. Remedy</b>	When the Toner Bottle empty was detected

<b>10-0404</b>	<b>Toner Bottle empty alarm (BK)</b>
<b>A. Operation / B. Cause / C. Remedy</b>	When the Toner Bottle empty was detected





# Service Mode

Overview.....	170
COPIER (Service mode for copier)...	172
TESTMODE (Service mode for test print, operation check, etc.).....	203

## Overview

### Entering Service Mode

For information on how to enter service mode, contact the Support Dept. of the sales company.

### Remote UI Service Mode

#### Function Overview

It is possible to display, configure, and execute various service mode modes as well as restart the host machine by using remote UI.

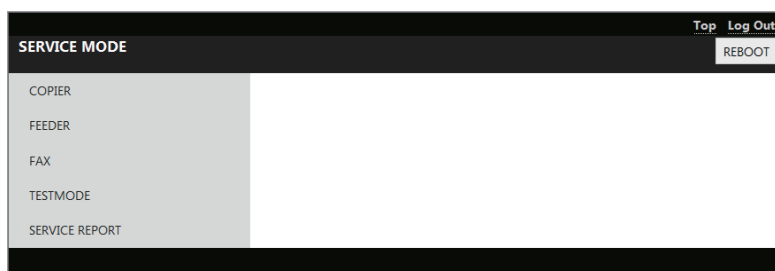

#### Operating conditions

In order to operate service mode using Remote UI, the following conditions must be met.

- Service mode is not used on the Control Panel.  
If service mode is accessed from the Control Panel of the host machine, "Log-in user exists already." is displayed when service mode is accessed from Remote UI.

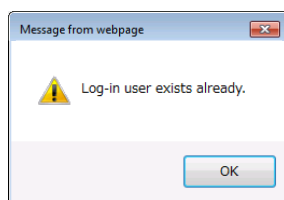

- When Remote UI service mode (this function) is not being logged in by other users  
When service mode is being accessed from Remote UI, "Remote service mode" is displayed on the UI of the host machine.

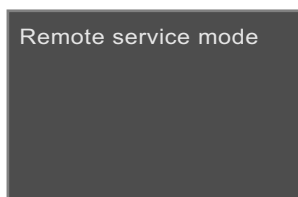

- When Remote UI is enabled in the setting on the Control Panel  
[Settings/Registration] > [System Settings] > [Remote UI Settings] > [Use Remote UI] > [ON]
- When the following setting (Remote UI service mode function) is enabled (setting value: 1) in service mode  
COPIER > OPTION > BODY > RMT-SW  
0:OFF(default), 1:ON



#### How to Use

1. **Activate the Web browser, and access the following URL:**  
<http://<Host machine's IP address or host name>/servicemode.html>

**2. Enter the password, and click [LOGIN].**

Password required for authentication differs depending on the following service mode setting: COPIER > OPTION > BODY > PSWD-SW

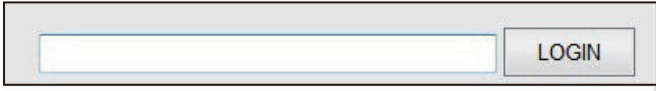
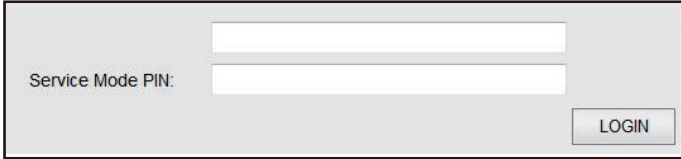
### Combinations of service mode settings and required passwords

PSWD-SW setting value	Password required for authentication	Authentication screen
0	<ul style="list-style-type: none"> <li>Password of remote UI service mode</li> </ul>	
1	<ul style="list-style-type: none"> <li>Password of remote UI service mode</li> <li>Service mode password</li> </ul>	
2	<ul style="list-style-type: none"> <li>Password of RUI service mode</li> <li>User's system administrator ID</li> <li>Password of system administrator</li> <li>Service mode password</li> </ul>	

**NOTE:**

- If you do not know the password of remote UI service mode, contact the Support Dept. of the sales company.
- Password of service mode can be changed in COPIER > OPTION > BODY > SM-PSWD.

**3. If you do not know the password of remote UI service mode, contact the Support Dept. of the sales company. When finishing the operation, click [REBOOT] or [Log Out].****NOTE:**

If the user logged in and then closed the browser without logging out, connection status remains as "LOGIN". If the user attempts to log in to service mode under "LOGIN" status, exclusive control is executed so that the user cannot access service mode. In that case, wait for a fixed time (3 minutes) from the last access to let the user be automatically logged out, or turn OFF/ON the power of the machine to be forcibly logged out.

## COPIER (Service mode for copier)

### DISPLAY (State display mode)

#### VERSION

COPIER (Service mode for copier) > DISPLAY (State display mode) > VERSION

<b>MAIN</b>	<b>Display of Bootable version</b>
<b>Detail</b>	To display the firmware version of Main Controller PCB.
<b>Use Case</b>	When upgrading the firmware
<b>Adj/Set/Operate Method</b>	N/A (Display only)
<b>Display/Adj/Set Range</b>	00.00 to 99.99
<b>BOOT</b>	<b>Display of BootROM version</b>
<b>Detail</b>	To display the version of Boot ROM (BOOT program).
<b>Use Case</b>	When upgrading the firmware
<b>Adj/Set/Operate Method</b>	N/A (Display only)
<b>Display/Adj/Set Range</b>	00.00 to 99.99
<b>LANG</b>	<b>Display of language pack version</b>
<b>Detail</b>	To display the version of language pack.
<b>Use Case</b>	When upgrading the firmware
<b>Adj/Set/Operate Method</b>	N/A (Display only)
<b>Display/Adj/Set Range</b>	00.00 to 99.99
<b>DEMODATA</b>	<b>Display of demo print data version</b>
<b>Detail</b>	To display the version of demo print data. For the models not having demo print function, "FF.FF" is displayed.
<b>Use Case</b>	When upgrading the firmware
<b>Adj/Set/Operate Method</b>	N/A (Display only)
<b>Display/Adj/Set Range</b>	00.00 to 99.99
<b>ECONT</b>	<b>Display of Engine Controller version</b>
<b>Detail</b>	To display the version of Engine Controller PCB.
<b>Use Case</b>	When upgrading the firmware
<b>Adj/Set/Operate Method</b>	N/A (Display only)
<b>Display/Adj/Set Range</b>	00.00 to 99.99
<b>PANEL</b>	<b>Display of firmware version of panel</b>
<b>Detail</b>	To display the firmware version of Control Panel CPU PCB.
<b>Use Case</b>	When upgrading the firmware
<b>Adj/Set/Operate Method</b>	N/A (Display only)
<b>Display/Adj/Set Range</b>	00.00 to 99.99
<b>Related Service Mode</b>	COPIER> FUNCTION> SYSTEM> PANEL-UP

## ADJUST (Adjustment mode)

### ■ FEED-ADJ

COPIER (Service mode for copier) > ADJUST (Adjustment mode) > FEED-ADJ

<b>ADJ-MFY</b>	<b>Adjustment of write start position in feed direction at Multi-purpose Tray pickup (1-sided print/2nd side of 2-sided print)</b>
<b>Detail</b>	To adjust the image write start position in the feed direction at the time of pickup from the Multi-purpose Tray. As the value is changed by 1, the leading edge margin is changed by 0.001 mm. +: Leading edge margin becomes larger. (An image moves to the trailing edge side.) -: Leading edge margin becomes smaller. (An image moves to the leading edge side.) When replacing the Engine Controller PCB/clearing RAM data, enter the value of service label. The setting is applied to the 1st side at 1-sided print and the 2nd side at 2-sided print.
<b>Use Case</b>	When replacing the Engine Controller PCB/clearing RAM data
<b>Adj/Set/Operate Method</b>	Enter the setting value (switch negative/positive by +/- key) and press Apply key.
<b>Display/Adj/Set Range</b>	-5080 to 5080
<b>Unit</b>	0.001 mm
<b>Default Value</b>	0
<b>ADJ-MFX</b>	<b>Adjustment of write start position in horizontal scanning direction at Multi-purpose Tray pickup (1-sided print/2nd side of 2-sided print)</b>
<b>Detail</b>	To adjust the write start position in the horizontal scanning direction for the image on the 1st side at the time of pickup from the Multi-purpose Tray. As the value is changed by 1, the left margin is changed by 0.001 mm. +: Left margin becomes larger. (An image moves to the right.) -: Left margin becomes smaller. (An image moves to the left.) When replacing the Engine Controller PCB/clearing RAM data, enter the value of service label. The setting is applied to the 1st side at 1-sided print and the 2nd side at 2-sided print.
<b>Use Case</b>	When replacing the Engine Controller PCB/clearing RAM data
<b>Adj/Set/Operate Method</b>	Enter the setting value (switch negative/positive by +/- key) and press Apply key.
<b>Display/Adj/Set Range</b>	-5080 to 5080
<b>Unit</b>	0.001 mm
<b>Default Value</b>	0
<b>ADJ-MFYR</b>	<b>Adjustment of write start position in feed direction at Multi-purpose Tray pickup (1st side of 2-sided print)</b>
<b>Detail</b>	To adjust the write start position in the feed direction for the image on the 2nd side at the time of pickup from the Multi-purpose Tray. As the value is changed by 1, the leading edge margin is changed by 0.001 mm. +: Leading edge margin becomes larger. (An image moves to the trailing edge side.) -: Leading edge margin becomes smaller. (An image moves to the leading edge side.) When replacing the Engine Controller PCB/clearing RAM data, enter the value of service label. The setting is applied to the 1st side at 2-sided print.
<b>Use Case</b>	When replacing the Engine Controller PCB/clearing RAM data
<b>Adj/Set/Operate Method</b>	Enter the setting value (switch negative/positive by +/- key) and press Apply key.
<b>Display/Adj/Set Range</b>	-5080 to 5080
<b>Unit</b>	0.001 mm
<b>Default Value</b>	0

COPIER (Service mode for copier) &gt; ADJUST (Adjustment mode) &gt; FEED-ADJ

<b>ADJ-MFXR</b>	<b>Adjustment of write start position in horizontal scanning direction at Multi-purpose Tray pickup (1st side of 2-sided print)</b>
<b>Detail</b>	To adjust the write start position in the horizontal scanning direction for the image on the 2nd side at the time of pickup from the Multi-purpose Tray. As the value is changed by 1, the left margin is changed by 0.001 mm. +: Left margin becomes larger. (An image moves to the right.) -: Left margin becomes smaller. (An image moves to the left.) When replacing the Engine Controller PCB/clearing RAM data, enter the value of service label. The setting is applied to the 1st side at 2-sided print.
<b>Use Case</b>	When replacing the Engine Controller PCB/clearing RAM data.
<b>Adj/Set/Operate Method</b>	Enter the setting value (switch negative/positive by +/- key) and press Apply key.
<b>Display/Adj/Set Range</b>	-5080 to 5080
<b>Unit</b>	0.001 mm
<b>Default Value</b>	0
<b>ADJ-C1Y</b>	<b>Adjustment of write start position in feed direction at Cassette 1 pickup (1-sided print/2nd side of 2-sided print)</b>
<b>Detail</b>	To adjust the image write start position in the feed direction at the time of pickup from the Cassette 1. As the value is changed by 1, the leading edge margin is changed by 0.001 mm. +: Leading edge margin becomes larger. (An image moves to the trailing edge side.) -: Leading edge margin becomes smaller. (An image moves to the leading edge side.) When replacing the Engine Controller PCB/clearing RAM data, enter the value of service label. The setting is applied to the 1st side at 1-sided print and the 2nd side at 2-sided print.
<b>Use Case</b>	When replacing the Engine Controller PCB/clearing RAM data
<b>Adj/Set/Operate Method</b>	Enter the setting value (switch negative/positive by +/- key) and press Apply key.
<b>Display/Adj/Set Range</b>	-5080 to 5080
<b>Unit</b>	0.001 mm
<b>Default Value</b>	0
<b>ADJ-C1X</b>	<b>Adjustment of write start position in horizontal scanning direction at Cassette 1 pickup (1-sided print/2nd side of 2-sided print)</b>
<b>Detail</b>	To adjust the write start position in the horizontal scanning direction for the image on the 1st side at the time of pickup from the Cassette 1. As the value is changed by 1, the left margin is changed by 0.001 mm. +: Left margin becomes larger. (An image moves to the right.) -: Left margin becomes smaller. (An image moves to the left.) When replacing the Engine Controller PCB/clearing RAM data, enter the value of service label. The setting is applied to the 1st side at 1-sided print and the 2nd side at 2-sided print.
<b>Use Case</b>	When replacing the Engine Controller PCB/clearing RAM data
<b>Adj/Set/Operate Method</b>	Enter the setting value (switch negative/positive by +/- key) and press Apply key.
<b>Display/Adj/Set Range</b>	-5080 to 5080
<b>Unit</b>	0.001 mm
<b>Default Value</b>	0

COPIER (Service mode for copier) &gt; ADJUST (Adjustment mode) &gt; FEED-ADJ

<b>ADJ-C1YR</b>	<b>Adjustment of write start position in feed direction at Cassette 1 pickup (1st side of 2-sided print)</b>
<b>Detail</b>	To adjust the write start position in the feed direction for the image on the 2nd side at the time of pickup from the Cassette 1. As the value is changed by 1, the leading edge margin is changed by 0.001 mm. +: Leading edge margin becomes larger. (An image moves to the trailing edge side.) -: Leading edge margin becomes smaller. (An image moves to the leading edge side.) When replacing the Engine Controller PCB/clearing RAM data, enter the value of service label. The setting is applied to the 1st side at 2-sided print.
<b>Use Case</b>	When replacing the Engine Controller PCB/clearing RAM data
<b>Adj/Set/Operate Method</b>	Enter the setting value (switch negative/positive by +/- key) and press Apply key.
<b>Display/Adj/Set Range</b>	-5080 to 5080
<b>Unit</b>	0.001 mm
<b>Default Value</b>	0
<b>ADJ-C1XR</b>	<b>Adjustment of write start position in horizontal scanning direction at Cassette 1 pickup (1st side of 2-sided print)</b>
<b>Detail</b>	To adjust the write start position in the horizontal scanning direction for the image on the 2nd side at the time of pickup from the Cassette 1. As the value is changed by 1, the left margin is changed by 0.001 mm. +: Left margin becomes larger. (An image moves to the right.) -: Left margin becomes smaller. (An image moves to the left.) When replacing the Engine Controller PCB/clearing RAM data, enter the value of service label. The setting is applied to the 1st side at 2-sided print.
<b>Use Case</b>	When replacing the Engine Controller PCB/clearing RAM data
<b>Adj/Set/Operate Method</b>	Enter the setting value (switch negative/positive by +/- key) and press Apply key.
<b>Display/Adj/Set Range</b>	-5080 to 5080
<b>Unit</b>	0.001 mm
<b>Default Value</b>	0
<b>ADJ-C2Y</b>	<b>Adjustment of write start position in feed direction at Cassette 2 pickup (1-sided print/2nd side of 2-sided print)</b>
<b>Detail</b>	To adjust the image write start position in the feed direction at the time of pickup from the Cassette 2. As the value is changed by 1, the leading edge margin is changed by 0.001 mm. +: Leading edge margin becomes larger. (An image moves to the trailing edge side.) -: Leading edge margin becomes smaller. (An image moves to the leading edge side.) When replacing the Engine Controller PCB/clearing RAM data, enter the value of service label. The setting is applied to the 1st side at 1-sided print and the 2nd side at 2-sided print.
<b>Use Case</b>	When replacing the Engine Controller PCB/clearing RAM data
<b>Adj/Set/Operate Method</b>	Enter the setting value (switch negative/positive by +/- key) and press Apply key.
<b>Display/Adj/Set Range</b>	-5080 to 5080
<b>Unit</b>	0.001 mm
<b>Default Value</b>	0

COPIER (Service mode for copier) &gt; ADJUST (Adjustment mode) &gt; FEED-ADJ

<b>ADJ-C2X</b>	<b>Adjustment of write start position in horizontal scanning direction at Cassette 2 pickup (1-sided print/2nd side of 2-sided print)</b>
<b>Detail</b>	To adjust the write start position in the horizontal scanning direction for the image on the 1st side at the time of pickup from the Cassette 2. As the value is changed by 1, the left margin is changed by 0.001 mm. +: Left margin becomes larger. (An image moves to the right.) -: Left margin becomes smaller. (An image moves to the left.) When replacing the Engine Controller PCB/clearing RAM data, enter the value of service label. The setting is applied to the 1st side at 1-sided print and the 2nd side at 2-sided print.
<b>Use Case</b>	When replacing the Engine Controller PCB/clearing RAM data
<b>Adj/Set/Operate Method</b>	Enter the setting value (switch negative/positive by +/- key) and press Apply key.
<b>Display/Adj/Set Range</b>	-5080 to 5080
<b>Unit</b>	0.001 mm
<b>Default Value</b>	0
<b>ADJ-C2YR</b>	<b>Adjustment of write start position in feed direction at Cassette 2 pickup (1st side of 2-sided print)</b>
<b>Detail</b>	To adjust the write start position in the feed direction for the image on the 2nd side at the time of pickup from the Cassette 2. As the value is changed by 1, the leading edge margin is changed by 0.001 mm. +: Leading edge margin becomes larger. (An image moves to the trailing edge side.) -: Leading edge margin becomes smaller. (An image moves to the leading edge side.) When replacing the Engine Controller PCB/clearing RAM data, enter the value of service label. The setting is applied to the 1st side at 2-sided print.
<b>Use Case</b>	When replacing the Engine Controller PCB/clearing RAM data
<b>Adj/Set/Operate Method</b>	Enter the setting value (switch negative/positive by +/- key) and press Apply key.
<b>Display/Adj/Set Range</b>	-5080 to 5080
<b>Unit</b>	0.001 mm
<b>Default Value</b>	0
<b>ADJ-C2XR</b>	<b>Adjustment of write start position in horizontal scanning direction at Cassette 2 pickup (1st side of 2-sided print)</b>
<b>Detail</b>	To adjust the write start position in the horizontal scanning direction for the image on the 2nd side at the time of pickup from the Cassette 2. As the value is changed by 1, the left margin is changed by 0.001 mm. +: Left margin becomes larger. (An image moves to the right.) -: Left margin becomes smaller. (An image moves to the left.) When replacing the Engine Controller PCB/clearing RAM data, enter the value of service label. The setting is applied to the 1st side at 2-sided print.
<b>Use Case</b>	When replacing the Engine Controller PCB/clearing RAM data
<b>Adj/Set/Operate Method</b>	Enter the setting value (switch negative/positive by +/- key) and press Apply key.
<b>Display/Adj/Set Range</b>	-5080 to 5080
<b>Unit</b>	0.001 mm
<b>Default Value</b>	0

## ■ PANEL

COPIER (Service mode for copier) &gt; ADJUST (Adjustment mode) &gt; PANEL

<b>TOUCHCHK</b>	<b>Adj of coordinate pstn on Touch Panel</b>
<b>Detail</b>	To adjust the coordinate position on the Touch Panel of the Control Panel. By making adjustment, the setting of TOUCH-R becomes 1.
<b>Use Case</b>	When replacing the LCD Panel
<b>Adj/Set/Operate Method</b>	1) Select the item, and then press Yes key. 2) Press the nine "+" keys in sequence.
<b>Related Service Mode</b>	COPIER> ADJUST> PANEL> TOUCH-R



COPIER (Service mode for copier) &gt; ADJUST (Adjustment mode) &gt; PANEL

TOUCH-R	Touch Panel coordinate pstn adj result
<b>Detail</b>	To set whether adjustment of the coordinate position on the Touch Panel of the Control Panel is completed. When adjustment with TOUCHCHK is completed, the setting of this item becomes 1.
<b>Use Case</b>	When replacing the LCD Panel
<b>Adj/Set/Operate Method</b>	Enter the setting value, and then press Apply key.
<b>Display/Adj/Set Range</b>	0 to 1 0: Not completed 1: Completed
<b>Default Value</b>	0
<b>Related Service Mode</b>	COPIER> ADJUST> PANEL> TOUCHCHK

## ■ VIFADJ

COPIER (Service mode for copier) &gt; ADJUST (Adjustment mode) &gt; VIFADJ

DEV-HV-Y	Adjustment of developing bias setting value (Y)
<b>Detail</b>	To adjust the setting value of Y-color developing bias.
<b>Use Case</b>	When an image failure occurs
<b>Adj/Set/Operate Method</b>	Enter the setting value (switch negative/positive by +/- key), and then press Apply key.
<b>Display/Adj/Set Range</b>	-5 to 5
<b>Default Value</b>	0
<b>Related Service Mode</b>	COPIER> ADJUST> VIFADJ> DEV-HV-M/C/K

DEV-HV-M	Adjustment of developing bias setting value (M)
<b>Detail</b>	To adjust the setting value of M-color developing bias.
<b>Use Case</b>	When an image failure occurs
<b>Adj/Set/Operate Method</b>	Enter the setting value (switch negative/positive by +/- key), and then press Apply key.
<b>Display/Adj/Set Range</b>	-5 to 5
<b>Default Value</b>	0
<b>Related Service Mode</b>	COPIER> ADJUST> VIFADJ> DEV-HV-Y/C/K

DEV-HV-C	Adjustment of developing bias setting value (C)
<b>Detail</b>	To adjust the setting value of C-color developing bias.
<b>Use Case</b>	When an image failure occurs
<b>Adj/Set/Operate Method</b>	Enter the setting value (switch negative/positive by +/- key), and then press Apply key.
<b>Display/Adj/Set Range</b>	-5 to 5
<b>Default Value</b>	0
<b>Related Service Mode</b>	COPIER> ADJUST> VIFADJ> DEV-HV-Y/M/K

DEV-HV-K	Adjustment of developing bias setting value (Bk)
<b>Detail</b>	To adjust the setting value of Bk-color developing bias.
<b>Use Case</b>	When an image failure occurs
<b>Adj/Set/Operate Method</b>	Enter the setting value (switch negative/positive by +/- key), and then press Apply key.
<b>Display/Adj/Set Range</b>	-5 to 5
<b>Default Value</b>	0
<b>Related Service Mode</b>	COPIER> ADJUST> VIFADJ> DEV-HV-Y/M/C

TR1-HV-Y	Not use
TR1-HV-M	Not use
TR1-HV-C	Not use
TR1-HV-K	Not use

COPIER (Service mode for copier) &gt; ADJUST (Adjustment mode) &gt; VIFADJ

<b>TR2SF-HV</b>	<b>Adj sec transfer bias set VL (1st side)</b>
<b>Detail</b>	To adjust the setting value of secondary transfer bias applied to the 1st side.
<b>Use Case</b>	When an image failure occurs
<b>Adj/Set/Operate Method</b>	Enter the setting value (switch negative/positive by +/- key), and then press Apply key.
<b>Display/Adj/Set Range</b>	-5 to 5
<b>Default Value</b>	0
<b>Related Service Mode</b>	COPIER> ADJUST> VIFADJ> TR2BK-HV
<b>TR2BK-HV</b>	<b>Adj sec transfer bias set VL (2nd side)</b>
<b>Detail</b>	To adjust the setting value of secondary transfer bias applied to the 2nd side.
<b>Use Case</b>	When an image failure occurs
<b>Adj/Set/Operate Method</b>	Enter the setting value (switch negative/positive by +/- key), and then press Apply key.
<b>Display/Adj/Set Range</b>	-5 to 5
<b>Default Value</b>	0
<b>Related Service Mode</b>	COPIER> ADJUST> VIFADJ> TR2SF-HV
<b>ICL-HV</b>	<b>Adj of ITB cleaning bias setting value</b>
<b>Detail</b>	To adjust the setting value of the bias to be applied at the time of ITB cleaning.
<b>Use Case</b>	When an image failure occurs
<b>Adj/Set/Operate Method</b>	Enter the setting value (switch negative/positive by +/- key), and then press Apply key.
<b>Display/Adj/Set Range</b>	-5 to 5
<b>Default Value</b>	0
<b>FU-TMP</b>	<b>Adj of Fixing Film surface temp set VL</b>
<b>Detail</b>	To adjust the setting value of the surface temperature of the Fixing Film.
<b>Use Case</b>	When an image failure occurs
<b>Adj/Set/Operate Method</b>	Enter the setting value (switch negative/positive by +/- key), and then press Apply key.
<b>Display/Adj/Set Range</b>	-2 to 2
<b>Default Value</b>	0

## ■ SCNR

COPIER (Service mode for copier) &gt; ADJUST (Adjustment mode) &gt; SCNR

<b>SUB-S-Y0</b>	<b>Not use</b>
<b>SUB-S-M0</b>	<b>Not use</b>
<b>SUB-S-C0</b>	<b>Not use</b>
<b>SUB-S-K0</b>	<b>Not use</b>
<b>SUB-S-Y1</b>	<b>Not use</b>
<b>SUB-S-M1</b>	<b>Not use</b>
<b>SUB-S-C1</b>	<b>Not use</b>
<b>SUB-S-K1</b>	<b>Not use</b>
<b>SUB-S-Y2</b>	<b>Not use</b>
<b>SUB-S-M2</b>	<b>Not use</b>
<b>SUB-S-C2</b>	<b>Not use</b>
<b>SUB-S-K2</b>	<b>Not use</b>
<b>MAI-S-Y0</b>	<b>Not use</b>
<b>MAI-S-M0</b>	<b>Not use</b>
<b>MAI-S-C0</b>	<b>Not use</b>

COPIER (Service mode for copier) &gt; ADJUST (Adjustment mode) &gt; SCNR

MAI-S-K0	Not use
MAI-S-Y1	Not use
MAI-S-M1	Not use
MAI-S-C1	Not use
MAI-S-K1	Not use
MAI-S-Y2	Not use
MAI-S-M2	Not use
MAI-S-C2	Not use
MAI-S-K2	Not use

## FUNCTION (Operation / inspection mode)

### ■ INSTALL

COPIER (Service mode for copier) &gt; FUNCTION (Operation / inspection mode) &gt; INSTALL

ERDS	ON/OFF of Embedded-RDS
<b>Detail</b>	To set whether to use the Embedded-RDS function.
<b>Use Case</b>	When using Embedded-RDS
<b>Adj/Set/Operate Method</b>	1) Enter the setting value, and then press Apply key. 2) Turn OFF/ON the main power switch.
<b>Caution</b>	Be sure to use ERDS, RGW-PORT, COM-TEST, COM-RSLT, and COM-LOG as a set.
<b>Display/Adj/Set Range</b>	0 to 1 0: OFF 1: ON
<b>Default Value</b>	It differs according to the location.
<b>Related Service Mode</b>	COPIER> FUNCTION> INSTALL> RGW-PORT, COM-TEST, COM-RSLT, COM-LOG
<b>Supplement/Memo</b>	Embedded-RDS: Function to send device information such as the device counter, failure, and consumables to UGW via SOAP protocol UGW (Universal Gate Way): Remote monitoring service system
RGW-PORT	Setting of UGW port number when using Embedded-RDS
<b>Detail</b>	To set the port number of UGW to be used for Embedded-RDS.
<b>Use Case</b>	When using Embedded-RDS
<b>Adj/Set/Operate Method</b>	1) Enter the setting value, and then press Apply key. 2) Turn OFF/ON the main power switch.
<b>Caution</b>	Be sure to use ERDS, RGW-PORT, COM-TEST, COM-RSLT, and COM-LOG as a set.
<b>Display/Adj/Set Range</b>	1 to 65535
<b>Default Value</b>	443
<b>Related Service Mode</b>	COPIER> FUNCTION> INSTALL> ERDS, COM-TEST, COM-RSLT, COM-LOG
<b>Supplement/Memo</b>	Embedded-RDS: Function to send device information such as the device counter, failure, and consumables to the sales company's server via SOAP protocol

COPIER (Service mode for copier) &gt; FUNCTION (Operation / inspection mode) &gt; INSTALL

<b>COM-TEST</b>		<b>Execution of Embedded-RDS communication test</b>
<b>Detail</b>	To execute Embedded-RDS communication test. If the connection fails, the information is added to the communication error log.	
<b>Use Case</b>	When using E-RDS	
<b>Adj/Set/Operate Method</b>	Select the item, and then press Yes key.	
<b>Caution</b>	Be sure to use ERDS, RGW-PORT, COM-TEST, COM-RSLT, and COM-LOG as a set.	
<b>Related Service Mode</b>	COPIER> FUNCTION> INSTALL> ERDS, RGW-PORT, COM-RSLT, COM-LOG	
<b>Supplement/Memo</b>	Embedded-RDS: Function to send device information such as the device counter, failure, and consumables to UGW via SOAP protocol UGW (Universal Gate Way): Remote monitoring service system	
<b>COM-RSLT</b>		<b>Display of Embedded-RDS comctn test result</b>
<b>Detail</b>	To display the Embedded-RDS communication test result.	
<b>Use Case</b>	When using E-RDS	
<b>Adj/Set/Operate Method</b>	N/A (Display only)	
<b>Caution</b>	Be sure to use ERDS, RGW-PORT, COM-TEST, COM-RSLT, and COM-LOG as a set.	
<b>Display/Adj/Set Range</b>	When not in execution: Unknown When connection is completed: OK When connection is failed: NG	
<b>Default Value</b>	Unknown	
<b>Related Service Mode</b>	COPIER> FUNCTION> INSTALL> ERDS, RGW-PORT, COM-TEST, COM-LOG	
<b>Supplement/Memo</b>	Embedded-RDS: Function to send device information such as the device counter, failure, and consumables to UGW via SOAP protocol UGW (Universal Gate Way): Remote monitoring service system	
<b>COM-LOG</b>		<b>Display of Embedded-RDS comctn error log</b>
<b>Detail</b>	To display the Embedded-RDS communication error log. The dates, times, and error codes of the latest 5 errors that occurred are displayed. As for the error detail information, the report can be output by executing ERDS-LOG.	
<b>Use Case</b>	When using Embedded-RDS	
<b>Adj/Set/Operate Method</b>	N/A (Display only)	
<b>Caution</b>	Be sure to use ERDS, RGW-PORT, COM-TEST, COM-RSLT, and COM-LOG as a set.	
<b>Display/Adj/Set Range</b>	Date: 6 digits Time: 4 digits Error code: 8 digits	
<b>Related Service Mode</b>	COPIER> FUNCTION> INSTALL> ERDS, RGW-PORT, COM-TEST, COM-RSLT COPIER> FUNCTION> MISC-P> ERDS-LOG	
<b>Supplement/Memo</b>	Embedded-RDS: Function to send device information such as the device counter, failure, and consumables to UGW via SOAP protocol UGW (Universal Gate Way): Remote monitoring service system	

## ■ CLEAR

COPIER (Service mode for copier) &gt; FUNCTION (Operation / inspection mode) &gt; CLEAR

<b>SRVC-DAT</b>		<b>Clearing of service mode setting values</b>
<b>Detail</b>	To clear the service mode setting values. The user mode setting values are not cleared. The factory adjustment values of the Reader/DADF are not initialized.	
<b>Adj/Set/Operate Method</b>	1) Select the item, and then press Yes key. 2) Turn OFF/ON the main power switch.	

COPIER (Service mode for copier) &gt; FUNCTION (Operation / inspection mode) &gt; CLEAR

<b>COUNTER</b>	<b>Clearing of service counter</b>
<b>Detail</b>	To clear the counter by maintenance/part. The numerator printed on a system dump list becomes 0.
<b>Adj/Set/Operate Method</b>	1) Select the item, and then press Yes key. 2) Turn OFF/ON the main power switch.
<b>HIST</b>	<b>Clearing of logs</b>
<b>Detail</b>	To clear the communication management/print/jam/alarm/error log.
<b>Use Case</b>	When clearing logs
<b>Adj/Set/Operate Method</b>	1) Select the item, and then press Yes key. 2) Turn OFF/ON the main power switch.
<b>ALL</b>	<b>Clearing of setting information</b>
<b>Detail</b>	To clear/initialize the following setting information according to the location set in LOCALE and SIZE-LC. - User mode setting values - Service mode setting values (excluding the service counter) - ID and password of the system administrator - Communication management/print/jam/alarm/error log - E719 error (counter meter-installed models only) The following items are not cleared/initialized. - Service counter - Factory adjustment values of the Reader/DADF
<b>Use Case</b>	At installation
<b>Adj/Set/Operate Method</b>	1) Select the item, and then press Yes key. 2) Turn OFF/ON the main power switch.
<b>Default Value</b>	0
<b>Related Service Mode</b>	COPIER> OPTION> BODY> LOCALE, SIZE-LC COPIER> FUNCTION> CLEAR> E719-CLR
<b>ERDS-DAT</b>	<b>Initialize of Embedded-RDS setting value</b>
<b>Detail</b>	To initialize the Embedded-RDS setting values. ON/OFF of Embedded-RDS, UGW port number and communication error log set in ERDS, RGW-PORT, and COM-LOG are cleared.
<b>Use Case</b>	When upgrading the Bootable in the Embedded-RDS environment
<b>Adj/Set/Operate Method</b>	Select the item, and then press Yes key.
<b>Caution</b>	Use of the SRAM in Embedded-RDS differs depending on the Bootable version. Therefore, unless initialization is executed at the time of version upgrade, data inconsistency occurs.
<b>Related Service Mode</b>	COPIER> FUNCTION> INSTALL> ERDS, RGW-PORT, COM-LOG
<b>Supplement/Memo</b>	Embedded-RDS: Function to send device information such as the device counter, failure, and consumables to UGW via SOAP protocol UGW (Universal Gate Way): Remote monitoring service system
<b>PLPW-CLR</b>	<b>Clear security policy setting password</b>
<b>Detail</b>	To clear the password of the security administrator set in the security policy settings.
<b>Use Case</b>	When clearing the password of the security administrator
<b>Adj/Set/Operate Method</b>	Select the item, and then press Yes key.

## ■ MISC-P

COPIER (Service mode for copier) > FUNCTION (Operation / inspection mode) > MISC-P

<b>SRVC-DAT</b>	<b>Output system data list/system dump list</b>
<b>Detail</b>	To output the system data list and the system dump list in the form of a report. System data list: The service software switches and parameters used in FAX function System dump list: The number of sends/receives, the number of pages sent/received, the number of sheets printed/read, the number of errors, etc.
<b>Adj/Set/Operate Method</b>	Select the item, and then press Yes key.
<b>Supplement/Memo</b>	FAX model only
<b>SYS-DAT</b>	<b>Output of system data list</b>
<b>Detail</b>	To output the system data list in the form of a report. The service software switches and parameters used in FAX function are output.
<b>Adj/Set/Operate Method</b>	Select the item, and then press Yes key.
<b>Supplement/Memo</b>	FAX model only
<b>SYS-DMP</b>	<b>Output of system dump list</b>
<b>Detail</b>	To output the system dump list in the form of a report. The number of sends/receives, the number of pages sent/received, the number of sheets printed/read, the number of errors, etc. are output.
<b>Adj/Set/Operate Method</b>	Select the item, and then press Yes key.
<b>Supplement/Memo</b>	FAX model only
<b>CNTR</b>	<b>Output of counter report</b>
<b>Detail</b>	To output the counter values in the form of a report. The usage of functions (reading, recording, communication and copy) is output.
<b>Adj/Set/Operate Method</b>	Select the item, and then press Yes key.
<b>ERR-LOG</b>	<b>Output of error log report</b>
<b>Detail</b>	To output the error log in the form of a report.
<b>Adj/Set/Operate Method</b>	Select the item, and then press Yes key.
<b>SPEC</b>	<b>Output of spec report</b>
<b>Detail</b>	To output the specifications in the form of a report. The current device specifications such as the location, model information, and ROM version are output.
<b>Adj/Set/Operate Method</b>	Select the item, and then press Yes key.
<b>ERDS-LOG</b>	<b>Output of Embedded-RDS log report</b>
<b>Detail</b>	To output the log relating to Embedded-RDS in the form of a report. The date, time, and code (8 digits) of each error that occurred are output.
<b>Use Case</b>	When using Embedded-RDS
<b>Adj/Set/Operate Method</b>	Select the item, and then press Yes key.
<b>Related Service Mode</b>	COPIER> FUNCTION> INSTALL> COM-LOG
<b>Supplement/Memo</b>	Embedded-RDS: Function to send device information such as the device counter, failure, and consumables to UGW via SOAP protocol UGW (Universal Gate Way): Remote monitoring service system
<b>CRG-LOG</b>	<b>Output cartridge replacement log report</b>
<b>Detail</b>	To output the cartridge replacement log in the form of a report.
<b>Use Case</b>	When checking the cartridge replacement log
<b>Adj/Set/Operate Method</b>	Select the item, and then press Yes key.

## ■ SYSTEM

COPIER (Service mode for copier) > FUNCTION (Operation / inspection mode) > SYSTEM

<b>DOWNLOAD</b>	<b>Upgrading of machine firmware: difference</b>
<b>Detail</b>	To upgrade the machine firmware using a USB flash drive. Compare the versions of firmware in the machine and the USB flash drive, and update the differences.
<b>Use Case</b>	At upgrade
<b>Adj/Set/Operate Method</b>	1) Connect the USB flash drive. 2) Select the item, and then press Yes key. The machine restarts in download mode.
<b>Caution</b>	Do not turn OFF/ON the power before "Executing..." disappears.
<b>Related Service Mode</b>	COPIER> FUNCTION> SYSTEM> DL-FORCE
<b>PANEL-UP</b>	<b>Upgrading of Control Panel CPU PCB firm</b>
<b>Detail</b>	To upgrade the firmware of the Control Panel CPU PCB using a USB flash drive. Upgrading is performed when PANEL exists in the root directory of the USB flash drive.
<b>Use Case</b>	At upgrade
<b>Adj/Set/Operate Method</b>	1. Connect the USB flash drive. 2. Select the item, and then press Yes. 3. Turn OFF/ON the main power.
<b>Caution</b>	Do not turn OFF/ON the power before "Executing..." disappears.
<b>Related Service Mode</b>	COPIER> DISPLAY> VERSION> PANEL
<b>LOGWRITE</b>	<b>Writing sublog to USB flash drive</b>
<b>Detail</b>	To write sublog that includes the following information to the USB flash drive. - Job list (job names, user names, and destinations) - Communications log (destinations and user names) - Job log (user names and job names)
<b>Use Case</b>	When analyzing the cause of a problem
<b>Adj/Set/Operate Method</b>	1. Connect the USB flash drive. 2. Select the item, and then press Yes. 3. Turn OFF/ON the main power.
<b>Caution</b>	Do not turn OFF/ON the power before "Executing..." disappears.
<b>Related Service Mode</b>	COPIER> FUNCTION> SYSTEM> LOG2USB
<b>IMPORT</b>	<b>Read s-mode set VL from USB flash drive</b>
<b>Detail</b>	To read the service mode setting information (excluding those related to Reader/DADF, but including those related to Finisher) from the USB flash drive.
<b>Use Case</b>	When replacing the Main Controller PCB
<b>Adj/Set/Operate Method</b>	1. Connect the USB flash drive. 2. Select the item, and then press Yes. 3. Turn OFF/ON the main power.
<b>Caution</b>	Do not turn OFF/ON the power before "Executing..." disappears.
<b>Related Service Mode</b>	COPIER> FUNCTION> SYSTEM> EXPORT
<b>EXPORT</b>	<b>Writing of service mode setting value to USB memory</b>
<b>Detail</b>	To write the service mode setting information (excluding those related to Reader/DADF, but including those related to Finisher) to the USB flash drive.
<b>Use Case</b>	When replacing the Main Controller PCB
<b>Adj/Set/Operate Method</b>	1) Connect the USB flash drive. 2) Select the item, and then press Yes key. "Executing..." disappears when writing is completed.
<b>Related Service Mode</b>	COPIER> FUNCTION> SYSTEM> IMPORT

COPIER (Service mode for copier) > FUNCTION (Operation / inspection mode) > SYSTEM

<b>SAVE-SM</b>	<b>Backup of service mode setting info</b>
<b>Detail</b>	To back up the service mode setting information (excluding those related to Reader/DADF, but including those related to Finisher) as a file to the USB flash drive using DCM function. The setting information which has been backed up can be restored with RSTR-SM.
<b>Use Case</b>	When saving the setting information before changing the service mode settings
<b>Adj/Set/Operate Method</b>	Select the item, and then press Yes key.
<b>Related Service Mode</b>	COPIER> FUNCTION> SYSTEM> RSTR-SM
<b>Supplement/Memo</b>	DCM (Device Configuration Management): A function to export/import the machine's setting information as a file.
<b>RSTR-SM</b>	<b>Restore of service mode setting info</b>
<b>Detail</b>	To restore the service mode setting information (excluding those related to Reader/DADF, but including those related to Finisher) which has been backed up with SAVE-SM from the USB flash drive using DCM function.
<b>Use Case</b>	When changing the service mode settings back to those before the change
<b>Adj/Set/Operate Method</b>	Select the item, and then press Yes key.
<b>Caution</b>	It is necessary to back up the setting information using SAVE-SM in order to restore the information with RSTR-SM.
<b>Related Service Mode</b>	COPIER> FUNCTION> SYSTEM> SAVE-SM
<b>Supplement/Memo</b>	DCM (Device Configuration Management): A function to export/import the machine's setting information as a file.
<b>LOG2USB</b>	<b>Writing of debug log to USB flash drive</b>
<b>Detail</b>	To write the debug log stored in the eMMC PCB to the USB flash drive.
<b>Use Case</b>	When analyzing the cause of a problem
<b>Adj/Set/Operate Method</b>	1) Connect the USB flash drive. 2) Select the item, and then press Yes key.
<b>Related Service Mode</b>	COPIER> FUNCTION> SYSTEM> LOGWRITE
<b>LOG-DEL</b>	<b>Deletion of debug log</b>
<b>Detail</b>	To delete the debug log stored in the eMMC PCB.
<b>Use Case</b>	When the debug log is no longer needed
<b>Adj/Set/Operate Method</b>	Select the item, and then press Yes key.
<b>DL-FORCE</b>	<b>Install machine firmware: overwriting</b>
<b>Detail</b>	To forcibly overwrite the machine firmware with the firmware stored in the USB flash drive.
<b>Use Case</b>	At upgrade/downgrade
<b>Adj/Set/Operate Method</b>	1) Connect the USB flash drive. 2) Select the item, and then press Yes key.
<b>Caution</b>	Do not turn OFF/ON the power before "Executing..." disappears.
<b>Related Service Mode</b>	COPIER> FUNCTION> SYSTEM> DOWNLOAD



## ■ SPLMAN

COPIER (Service mode for copier) > FUNCTION (Operation / inspection mode) > SPLMAN

<b>SPL14159</b>	<b>ON/OFF of USB device ID fixing</b>
<b>Detail</b>	To set whether to fix the USB device ID to "000000000000". A PC attempts to install the driver every time it is connected to a machine. However, by fixing the USB device ID, it recognizes that the same machine is connected so that it does not attempt to install the driver again.
<b>Use Case</b>	When saving the trouble of selecting a device used for printing from the candidate devices because the driver is installed every time a USB is connected
<b>Adj/Set/Operate Method</b>	1) Enter the setting value, and then press Apply key. 2) Turn OFF/ON the main power switch.
<b>Display/Adj/Set Range</b>	0 to 1 0: OFF, 1: ON
<b>Default Value</b>	0
<b>SPL37510</b>	<b>ON/OFF of ITB cleaning at paper size mismatch</b>
<b>Detail</b>	Normally, when paper other than that of the specified size is fed, ITB cleaning is executed to remove toner. When 1 is set, ITB cleaning is not executed even if paper size is mismatched. Productivity improves, but toner soiling may occur.
<b>Use Case</b>	When paper size is mismatched
<b>Adj/Set/Operate Method</b>	Enter the setting value, and then press Apply key.
<b>Caution</b>	Be sure to get approval from the user by telling that toner soiling may occur to improve productivity.
<b>Display/Adj/Set Range</b>	0 to 1 0: OFF 1: ON
<b>Default Value</b>	0
<b>SPL65677</b>	<b>Increase of paper leading edge margin</b>
<b>Detail</b>	To increase the margin on the leading edge of paper. As the value is incremented by 1, the margin is increased by 0.1 mm. Actually, a value where the setting value of SPL68676 is subtracted from the setting value of this item is applied. The margin settings which are job-specific or based on the printable area are applied regardless of the setting of this item.
<b>Adj/Set/Operate Method</b>	1) Enter the setting value, and then press Apply key. 2) Turn OFF/ON the main power switch.
<b>Display/Adj/Set Range</b>	0 to 20
<b>Unit</b>	0.1 mm
<b>Default Value</b>	0
<b>Related Service Mode</b>	COPIER> FUNCTION> SPLMAN> SPL68676
<b>SPL68676</b>	<b>Decrease of paper leading edge margin</b>
<b>Detail</b>	To decrease the margin on the leading edge of paper. As the value is incremented by 1, the margin is decreased by 0.1 mm. Actually, a value where the setting value of this item is subtracted from the setting value of SPL65677 is applied. The margin settings which are job-specific or based on the printable area are applied regardless of the setting of this item.
<b>Adj/Set/Operate Method</b>	1) Enter the setting value, and then press Apply key. 2) Turn OFF/ON the main power switch.
<b>Display/Adj/Set Range</b>	0 to 20
<b>Unit</b>	0.1 mm
<b>Default Value</b>	0
<b>Related Service Mode</b>	COPIER> FUNCTION> SPLMAN> SPL65677

COPIER (Service mode for copier) &gt; FUNCTION (Operation / inspection mode) &gt; SPLMAN

<b>SPL68677</b>	<b>Increase of paper right and left margins</b>
<b>Detail</b>	To increase the margins on the right and left edges of paper. As the value is incremented by 1, the margin is increased by 0.1 mm. Actually, a value where the setting value of SPL25607 is subtracted from the setting value of this item is applied. The margin settings which are job-specific or based on the printable area are applied regardless of the setting of this item.
<b>Adj/Set/Operate Method</b>	1) Enter the setting value, and then press Apply key. 2) Turn OFF/ON the main power switch.
<b>Display/Adj/Set Range</b>	0 to 20
<b>Unit</b>	0.1 mm
<b>Default Value</b>	0
<b>Related Service Mode</b>	COPIER> FUNCTION> SPLMAN> SPL25607
<b>SPL25607</b>	<b>Decrease of paper right and left margins</b>
<b>Detail</b>	To decrease the margins on the right and left edges of paper. As the value is incremented by 1, the margin is decreased by 0.1 mm. Actually, a value where the setting value of this item is subtracted from the setting value of SPL68677 is applied. The margin settings which are job-specific or based on the printable area are applied regardless of the setting of this item.
<b>Adj/Set/Operate Method</b>	1) Enter the setting value, and then press Apply key. 2) Turn OFF/ON the main power switch.
<b>Display/Adj/Set Range</b>	0 to 20
<b>Unit</b>	0.1 mm
<b>Default Value</b>	0
<b>Related Service Mode</b>	COPIER> FUNCTION> SPLMAN> SPL68677
<b>SPL93822</b>	<b>Setting of department ID count all clear</b>
<b>Detail</b>	To set whether to disable clearing of all department ID counts.
<b>Use Case</b>	When prohibiting clearing of all department ID counts
<b>Adj/Set/Operate Method</b>	1) Enter the setting value, and then press Apply key. 2) Turn OFF/ON the main power switch.
<b>Caution</b>	Be sure to perform this mode after consulting with the system administrator at user's site.
<b>Display/Adj/Set Range</b>	0 to 1 0: Disabled 1: Enabled
<b>Default Value</b>	0
<b>Related Service Mode</b>	COPIER> FUNCTION> SPLMAN> SPL78788
<b>SPL78788</b>	<b>Setting of department ID count clear</b>
<b>Detail</b>	To set whether to disable clearing of department ID count.
<b>Use Case</b>	When prohibiting clearing of department ID count
<b>Adj/Set/Operate Method</b>	1) Enter the setting value, and then press Apply key. 2) Turn OFF/ON the main power switch.
<b>Caution</b>	Be sure to perform this mode after consulting with the system administrator at user's site.
<b>Display/Adj/Set Range</b>	0 to 1 0: Disabled 1: Enabled
<b>Default Value</b>	0
<b>Related Service Mode</b>	COPIER> FUNCTION> SPLMAN> SPL93822

COPIER (Service mode for copier) &gt; FUNCTION (Operation / inspection mode) &gt; SPLMAN

<b>SPL41250</b>	<b>Initialize color displacement correction</b>
<b>Detail</b>	To initialize the color displacement correction result. If shortage of toner occurs while [Continue Printing (Quality Not Guaranteed)] is selected by the user, color displacement correction cannot be executed. If color displacement correction cannot be executed while 1 is set, printing is continued based on the setting at the time of factory shipment. When 1 is set in the case that color displacement correction fails after replacement of the cartridge, the correction may succeed.
<b>Use Case</b>	- When prioritizing productivity over image quality - When color displacement correction fails even though there is sufficient toner remains
<b>Adj/Set/Operate Method</b>	1) Select the item, and then press Yes key. 2) Turn OFF/ON the main power switch. 3) Execute print color displacement correction.
<b>Caution</b>	- Do not turn OFF/ON the power before "Executing..." disappears. - Be sure to perform print color displacement correction after turning OFF/ON the power.
<b>Additional Functions Mode</b>	Adjustment/Maintenance> Adjust Image Quality> Correct Print Color Mismatch
<b>SPL71100</b>	<b>Setting of the duty of Off-hook PCB</b>
<b>Detail</b>	This is the mode to make handsets of particular manufacturers to ring when fax reception mode is set to "Fax / Tel (Auto Switch)".
<b>Use Case</b>	When making the handsets of particular manufacturers to ring at the time of switching Fax/Tel
<b>Adj/Set/Operate Method</b>	1) Enter the setting value, and then press Apply key. 2) Turn OFF/ON the main power switch.
<b>Display/Adj/Set Range</b>	1 to 99
<b>Default Value</b>	50
<b>Supplement/Memo</b>	FAX model only
<b>SPL00171</b>	<b>Set auto sleep shift time maximum value</b>
<b>Detail</b>	To set the maximum auto sleep shift time displayed in [Auto Sleep Time] in [Settings/Registration]. When 0 is set, the time that can be set is 60 minutes maximum.
<b>Use Case</b>	When changing the setting time to shift to auto sleep mode
<b>Adj/Set/Operate Method</b>	1) Enter the setting value, and then press Apply key. 2) Turn OFF/ON the main power switch.
<b>Display/Adj/Set Range</b>	0 to 1 0: 60 minutes 1: Time specified for each model
<b>Default Value</b>	0 (Europe)/1 (Others)
<b>Additional Functions Mode</b>	Timer Settings> Auto Sleep Time
<b>SPL80100</b>	<b>ON/OFF image left edge mask: book mode</b>
<b>Detail</b>	To set whether to mask the left edge of the image at copyboard reading. When 0 is set, mask with the width based on the specification is applied for each job. When 1 is set, mask is canceled.
<b>Use Case</b>	Upon user's request (to print the left edge of the image)
<b>Adj/Set/Operate Method</b>	1) Enter the setting value, and then press Apply key. 2) Turn OFF/ON the main power switch.
<b>Display/Adj/Set Range</b>	0 to 1 0: ON, 1: OFF
<b>Default Value</b>	0
<b>SPL27354</b>	<b>For R&amp;D</b>

COPIER (Service mode for copier) &gt; FUNCTION (Operation / inspection mode) &gt; SPLMAN

<b>SPL84194</b>	<b>ON/OFF of Embedded-RDS</b>
<b>Detail</b>	To set ON/OFF of Embedded-RDS function.
<b>Use Case</b>	When using Embedded-RDS
<b>Adj/Set/Operate Method</b>	1) Enter the setting value, and then press Apply key. 2) Turn OFF/ON the main power switch.
<b>Display/Adj/Set Range</b>	0 to 1 0: ON, 1: OFF
<b>Default Value</b>	It differs according to the location.
<b>Supplement/Memo</b>	Embedded-RDS: Function to send device information such as the device counter, failure, and consumables to UGW via SOAP protocol UGW (Universal Gate Way): Remote monitoring service system
<b>SPL32620</b>	<b>ON/OFF of PC-less update function</b>
<b>Detail</b>	To set whether to disable the PC-less update function.
<b>Adj/Set/Operate Method</b>	1) Enter the setting value, and then press Apply key. 2) Turn OFF / ON the main power switch.
<b>Caution</b>	When LCDSFLG is 1, the setting of this item is disabled (the PC-less update function is turned OFF).
<b>Display/Adj/Set Range</b>	0 to 1 0: OFF, 1: ON
<b>Default Value</b>	1
<b>Related Service Mode</b>	COPIER> OPTION> FNC-SW> LCDSFLG
<b>Supplement/Memo</b>	PC-less update: A function to directly download the firmware from the GDLS server and update it.
<b>SPL60061</b>	<b>Dspl/hide cloud print connct dest URL chng scrn</b>
<b>Detail</b>	To set whether to display or hide the connection destination URL settings for Google Cloud Print on remote UI.
<b>Use Case</b>	When Google has changed the connection destination URL for cloud print
<b>Adj/Set/Operate Method</b>	1) Enter the setting value, and then press Apply key. 2) Turn OFF / ON the main power switch.
<b>Display/Adj/Set Range</b>	0 to 1 0: Display 1: Hide
<b>SPL71700</b>	<b>Writing sublog to USB flash drive</b>
<b>Detail</b>	To write the sublog stored in the eMMC PCB to the USB flash drive.
<b>Use Case</b>	When analyzing the cause of a problem
<b>Adj/Set/Operate Method</b>	Select the item, and then press Yes key.
<b>SPL01734</b>	<b>ON/OFF of remote UI service mode</b>
<b>Detail</b>	To set whether to allow using service mode on remote UI.
<b>Use Case</b>	When using service mode on remote UI
<b>Adj/Set/Operate Method</b>	1) Enter the setting value, and then press Apply key. 2) Turn OFF/ON the main power switch.
<b>Caution</b>	The setting value is linked with that of RMT-SW.
<b>Display/Adj/Set Range</b>	0 to 1 0: OFF, 1: ON
<b>Default Value</b>	1
<b>Related Service Mode</b>	COPIER> OPTION> BODY> RMT-SW
<b>SPL39533</b>	<b>ON/OFF of department ID management</b>
<b>Detail</b>	To set whether to disable the department ID management.
<b>Use Case</b>	When disabling the department ID management
<b>Adj/Set/Operate Method</b>	Select the item, and then press Yes key.

COPIER (Service mode for copier) &gt; FUNCTION (Operation / inspection mode) &gt; SPLMAN

<b>SPL43810</b>		<b>Clear of system administrator settings</b>
<b>Detail</b>	To completely delete the following setting information. - System Manager ID - PIN After clearing of the information, it is necessary to set the system manager ID/PIN again.	
<b>Use Case</b>	When the system manager ID/PIN has been forgotten	
<b>Adj/Set/Operate Method</b>	Select the item, and then press Yes key.	
<b>Caution</b>	Do not forget to set the system manager ID/PIN after clearing of the information.	
<b>SPL08159</b>		<b>ON/OFF of fax image backup data clear</b>
<b>Detail</b>	To set whether to clear the fax image data which has been backed up. When 1 is set, it is cleared at next startup.	
<b>Adj/Set/Operate Method</b>	Enter the setting value, and then press Apply key.	
<b>Display/Adj/Set Range</b>	0 to 1 0: OFF, 1: ON	
<b>Default Value</b>	0	
<b>SPL97097</b>		<b>ON/OFF of user setting backup data clear</b>
<b>Detail</b>	To set whether to clear all the user setting data which has been backed up. When 1 is set, it is cleared at next startup.	
<b>Adj/Set/Operate Method</b>	Enter the setting value, and then press Apply key.	
<b>Display/Adj/Set Range</b>	0 to 1 0: OFF, 1: ON	
<b>Default Value</b>	1	

## ■ VIFFNC

COPIER (Service mode for copier) &gt; FUNCTION (Operation / inspection mode) &gt; VIFFNC

<b>SMEAR-PV</b>		<b>ON/OFF of image smear prevention mode</b>
<b>Detail</b>	To set whether to execute the image smear prevention mode. Depending on the paper type or environment (especially in a high humidity environment), thin line or fine halftone may become lighter	
<b>Use Case</b>	When thin line or fine halftone becomes lighter	
<b>Adj/Set/Operate Method</b>	Enter the setting value, and then press Apply key.	
<b>Display/Adj/Set Range</b>	0 to 1 0: OFF, 1: ON	
<b>Default Value</b>	0	
<b>FEED-IMP</b>		<b>ON/OFF of pickup jam reduction mode</b>
<b>Detail</b>	To set whether to execute the pickup jam reduction mode. When using paper with which double feed is more likely to occur, pickup operation cannot be performed at the appropriate timing because of double feed. As a result of that, pickup delay jam may occur. In such cases, the pickup interval is extended by setting 1. As a result of that, jam occurrence can be reduced, but productivity is decreased.	
<b>Use Case</b>	When pickup jam occurs with paper with which double feed is more likely to occur	
<b>Adj/Set/Operate Method</b>	Enter the setting value, and then press Apply key.	
<b>Caution</b>	Be sure to get approval from the user by telling that the productivity decreases to prevent jam occurrence.	
<b>Display/Adj/Set Range</b>	0 to 1 0: OFF, 1: ON	
<b>Default Value</b>	0	

COPIER (Service mode for copier) &gt; FUNCTION (Operation / inspection mode) &gt; VIFFNC

<b>FOG-PV</b>		<b>ON/OFF of image fogging prevention mode</b>
<b>Detail</b>		To set whether to execute the image fogging prevention mode. Set 1 when fogging which looks like fine vertical lines appears. Execute the image fogging prevention mode.
<b>Use Case</b>		When fogging which looks like fine vertical lines occurs
<b>Adj/Set/Operate Method</b>		Enter the setting value, and then press Apply key.
<b>Display/Adj/Set Range</b>		0 to 1 0: OFF, 1: ON
<b>Default Value</b>		0
<b>ICL-IMP</b>		<b>ON/OFF ITB clean failure alleviate mode</b>
<b>Detail</b>		To set whether to execute ITB cleaning failure alleviation mode. An image that was on 2 sheets before may appear lightly depending on paper type and image ratio (in case of high image ratio). In such a case, set 1 to execute process to alleviate ITB cleaning failure.
<b>Use Case</b>		When an image failure (ghosting of an image on the 2 sheets before) occurs
<b>Adj/Set/Operate Method</b>		Enter the setting value, and then press Apply key.
<b>Display/Adj/Set Range</b>		0 to 1 0: OFF, 1: ON
<b>Default Value</b>		0
<b>FD-R-CHG</b>		<b>Not use</b>
<b>STOR-DCN</b>		<b>Backup of Engine Controller PCB NVRAM</b>
<b>Detail</b>		To back up the setting information in NVRAM of the Engine Controller PCB to NVRAM of the Main Controller PCB.
<b>Use Case</b>		Before replacing the Engine Controller PCB
<b>Adj/Set/Operate Method</b>		Select the item, and then press Yes key.
<b>Caution</b>		During operation, the setting information changes by manual or automatic adjustment. When backup data which has been left for a long period of time is restored, it is overwritten with the old setting information and the new information is deleted.
<b>Related Service Mode</b>		COPIER> FUNCTION> SYSTEM> RSTR-DCN
<b>RSTR-DCN</b>		<b>Restoration of Engine Controller PCB NVRAM</b>
<b>Detail</b>		To restore the setting information which has been backed up to NVRAM of the Main Controller PCB to the NVRAM of the Engine Controller PCB.
<b>Use Case</b>		After replacing the Engine Controller PCB
<b>Adj/Set/Operate Method</b>		1) Select the item, and then press Yes key. 2) Turn OFF/ON the main power switch.
<b>Caution</b>		During operation, the setting information changes by manual or automatic adjustment. When backup data which has been left for a long period of time is restored, it is overwritten with the old setting information and the new information is deleted.
<b>Related Service Mode</b>		COPIER> FUNCTION> SYSTEM> STOR-DCN

## OPTION (Specification setting mode)

### ■ BODY

COPIER (Service mode for copier) > OPTION (Specification setting mode) > BODY

LOCALE	Setting of location
<b>Detail</b>	To set the location. Set the location in this item and the paper size configuration in SIZE-LC, and then clear the setting information in ALL.
<b>Use Case</b>	- When replacing the Main Controller PCB - When changing the location information
<b>Adj/Set/Operate Method</b>	1) Enter the setting value in this item, and then press Apply key. 2) Set the paper size configuration in SIZE-LC. 3) Execute ALL. 4) Turn OFF/ON the main power switch.
<b>Caution</b>	The setting information such as user mode and service mode is initialized by executing ALL. The settings of this item and SIZE-LC are not initialized.
<b>Display/Adj/Set Range</b>	1 to 10 1: Japan 2: North America 3: Korea 4: China 5: Taiwan 6: Europe 7: Asia 8: Oceania 9: Brazil 10: Latin
<b>Related Service Mode</b>	COPIER> FUNCTION> CLEAR> ALL COPIER> OPTION> BODY> SIZE-LC
SIZE-LC	Setting of paper size configuration
<b>Detail</b>	To set the paper size configuration. When replacing the Main Controller PCB, set the location in LOCALE and the paper size configuration in this item, and then clear the setting information in ALL.
<b>Use Case</b>	- When replacing the Main Controller PCB - Upon user's request
<b>Adj/Set/Operate Method</b>	1) Set the location in LOCALE. 2) Enter the setting value in this item, and then press Apply key. 3) Execute ALL. 4) Turn OFF/ON the main power switch.
<b>Caution</b>	The setting information such as user mode and service mode is initialized by executing ALL. The settings of this item and LOCALE are not initialized.
<b>Display/Adj/Set Range</b>	1 to 4 1: AB configuration 2: Inch configuration 3: A configuration 4: AB/Inch configuration
<b>Related Service Mode</b>	COPIER> FUNCTION> CLEAR> ALL COPIER> OPTION> BODY> LOCALE

COPIER (Service mode for copier) &gt; OPTION (Specification setting mode) &gt; BODY

<b>MIBCOUNT</b>	<b>Set of charge counter MIB scope range</b>
<b>Detail</b>	To set the range of counter information that can be obtained as MIB (Management Information Base).
<b>Adj/Set/Operate Method</b>	1) Enter the setting value, and then press Apply key. 2) Turn OFF/ON the main power switch.
<b>Display/Adj/Set Range</b>	0 to 2 0: All charge counters are obtained 1: Only displayed counter* is obtained 2: All charge counters are not obtained * : Counter specified by COUNTER 1 to 6
<b>Default Value</b>	0
<b>Related Service Mode</b>	COPIER> OPTION> USER> COUNTER1 - 6
<b>NS-CMD5</b>	<b>Limit CRAM-MD5 auth method: SMTP auth</b>
<b>Detail</b>	To restrict use of CRAM-MD5 authentication method at the time of SMTP authentication.
<b>Use Case</b>	Upon user's request
<b>Adj/Set/Operate Method</b>	1) Enter the setting value, and then press Apply key. 2) Turn OFF/ON the main power switch.
<b>Display/Adj/Set Range</b>	0 to 1 0: SMTP server-dependent 1: Not used
<b>Default Value</b>	0
<b>Supplement/Memo</b>	SMTP authentication: Protocol in which user authentication function is added to SMTP, which is the protocol to be used for e-mail transmission. At the time of e-mail transmission, this protocol executes authentication of the user account and the password between the SMTP server and the user to approve e-mail transmission only when it's authenticated.
<b>NS-PLN</b>	<b>Limit plaintext auth: SMTP auth, noency</b>
<b>Detail</b>	To restrict use of PLAIN/LOGIN authentication, which is plaintext, at the time of SMTP authentication under the environment where the communication packet is not encrypted.
<b>Use Case</b>	Upon user's request
<b>Adj/Set/Operate Method</b>	1) Enter the setting value, and then press Apply key. 2) Turn OFF/ON the main power switch.
<b>Display/Adj/Set Range</b>	0 to 1 0: SMTP server-dependent 1: Not used
<b>Default Value</b>	0
<b>Supplement/Memo</b>	SMTP authentication: Protocol in which user authentication function is added to SMTP, which is the protocol to be used for e-mail transmission. At the time of e-mail transmission, this protocol executes authentication of the user account and the password between the SMTP server and the user to approve e-mail transmission only when it's authenticated.
<b>NS-LGN</b>	<b>Limit LOGIN authentication: SMTP auth</b>
<b>Detail</b>	To restrict use of LOGIN authentication at the time of SMTP authentication.
<b>Use Case</b>	Upon user's request
<b>Adj/Set/Operate Method</b>	1) Enter the setting value, and then press Apply key. 2) Turn OFF/ON the main power switch.
<b>Display/Adj/Set Range</b>	0 to 1 0: SMTP server-dependent 1: Not used
<b>Default Value</b>	0
<b>Supplement/Memo</b>	SMTP authentication: Protocol in which user authentication function is added to SMTP, which is the protocol to be used for e-mail transmission. At the time of e-mail transmission, this protocol executes authentication of the user account and the password between the SMTP server and the user to approve e-mail transmission only when it's authenticated.



COPIER (Service mode for copier) &gt; OPTION (Specification setting mode) &gt; BODY

<b>SLPMODE</b>		<b>Setting of shift to sleep mode</b>
<b>Detail</b>	To restrict shift to sleep mode 1/sleep mode 3. When 1 is set, the machine does not shift to sleep mode.	
<b>Use Case</b>	When sleep failure occurs	
<b>Adj/Set/Operate Method</b>	1) Enter the setting value, and then press Apply key. 2) Turn OFF/ON the main power switch.	
<b>Display/Adj/Set Range</b>	0 to 1 0 : Shift is available. 1 : Shift is not available.	
<b>Default Value</b>	0	
<b>SDTM-DSP</b>		<b>ON/OFF of auto shutdown shift time dspl</b>
<b>Detail</b>	To set whether to display [Auto Shutdown Time] in [Menu]. The setting is enabled only for the model with automatic shutdown function.	
<b>Use Case</b>	When switching to display or hide the items related to auto shutdown	
<b>Adj/Set/Operate Method</b>	Enter the setting value, and then press Apply key.	
<b>Caution</b>	For the model without automatic shutdown function, the setting is disabled even if it is configured.	
<b>Display/Adj/Set Range</b>	0 to 1 0: OFF 1: ON	
<b>Default Value</b>	It differs according to the location.	
<b>Additional Functions Mode</b>	Preferences> Timer/Energy Settings> Auto Shutdown Time	
<b>RMT-SW</b>		<b>ON/OFF of remote UI service mode</b>
<b>Detail</b>	To set whether to allow using service mode on remote UI.	
<b>Use Case</b>	When using service mode on remote UI	
<b>Adj/Set/Operate Method</b>	1) Enter the setting value, and then press Apply key. 2) Turn OFF/ON the main power switch.	
<b>Display/Adj/Set Range</b>	0 to 1 0: OFF, 1: ON	
<b>Default Value</b>	1	
<b>PSWD-SW</b>		<b>Set password type to enter service mode</b>
<b>Detail</b>	To set the type of password that is required to enter when getting into service mode. 2 types are available: one for "service technician" and the other for "system administrator + service technician". When selecting the type for "system administrator + service technician", enter the password for service technician after the password entry by the user's system administrator.	
<b>Use Case</b>	Upon request from the user who concerns security	
<b>Adj/Set/Operate Method</b>	1) Enter the setting value, and then press Apply key. 2) Turn OFF/ON the main power switch.	
<b>Display/Adj/Set Range</b>	0 to 2 0: No password 1: Service technician 2: System administrator + service technician	
<b>Default Value</b>	0	

COPIER (Service mode for copier) &gt; OPTION (Specification setting mode) &gt; BODY

<b>SM-PSWD</b>	<b>Password setting for service technician</b>
<b>Detail</b>	To set password for service technician that is used when getting into service mode.
<b>Use Case</b>	When password is required to get into service mode
<b>Adj/Set/Operate Method</b>	1) Enter the setting value, and then press Apply key. 2) Turn OFF/ON the main power switch.
<b>Caution</b>	Be sure to select 1 or 2 with PSWD-SW in advance.
<b>Display/Adj/Set Range</b>	11111111 to 99999999
<b>Default Value</b>	11111111
<b>Related Service Mode</b>	COPIER> OPTION> BODY> PSWD-SW

## ■ FNC-SW

COPIER (Service mode for copier) &gt; OPTION (Specification setting mode) &gt; FNC-SW

<b>IMGCNTPR</b>	<b>Setting of image quality mode</b>
<b>Detail</b>	To set the image quality mode. When 0 is set, "image quality priority mode" is applied. When 1 is set, "counter priority mode" is applied. When 2 is set, "image quality priority (photo) mode" is applied.
<b>Use Case</b>	Upon user's request
<b>Adj/Set/Operate Method</b>	Enter the setting value, and then press Apply key.
<b>Display/Adj/Set Range</b>	0 to 2 0: Image quality priority mode 1: Counter priority mode 2: Image quality priority (photo) mode
<b>Default Value</b>	1
<b>LCDSFLG</b>	<b>Enabling of local CDS server</b>
<b>Detail</b>	To set whether to use the local CDS server.
<b>Use Case</b>	When using the local CDS server
<b>Adj/Set/Operate Method</b>	Enter the setting value, and then press Apply key.
<b>Display/Adj/Set Range</b>	0 to 1 0: Disabled 1: Enabled
<b>Default Value</b>	0
<b>Related Service Mode</b>	COPIER> FUNCTION> SPLMAN> SPL32620
<b>Supplement/Memo</b>	When local CDS is used, iW EMC/MC device firmware update plug-in is required.
<b>CRG-PROC</b>	<b>Set oprtn at cartridge estd life reach</b>
<b>Detail</b>	To set the operation of the machine when the parts counter of the cartridge reaches the estimated life value.
<b>Adj/Set/Operate Method</b>	Enter the setting value, and then press Apply key.
<b>Display/Adj/Set Range</b>	0 to 2 0: Not stopped 1: Stopped once 2: Completely stopped
<b>Default Value</b>	0

COPIER (Service mode for copier) &gt; OPTION (Specification setting mode) &gt; FNC-SW

<b>CRGLF-K</b>		<b>Set replacement ref VL (Bk): drum, etc.</b>
<b>Detail</b>	To set the reference values for judging replacement of the component other than toner (Photosensitive Drum, Developing Assembly, and waste toner) included in the life of Bk-color cartridge. These values are used as the basis for calculation of component other than toner when deriving the estimated life value of the cartridge.	
<b>Use Case</b>	When toner consumption is low (when the life of the Photosensitive Drum or the Developing Assembly decreases faster than that of toner)	
<b>Adj/Set/Operate Method</b>	Enter the setting value, and then press Apply key.	
<b>Display/Adj/Set Range</b>	100 to 200	
<b>Unit</b>	1%	
<b>Default Value</b>	100	

<b>CRGLF-CL</b>		<b>Set replacement ref VL(Y/M/C):drum, etc.</b>
<b>Detail</b>	To set the reference values for judging replacement of the component other than toner (Photosensitive Drum, Developing Assembly, and waste toner) included in the life of Y/M/C-color cartridge. These values are used as the basis for calculation of component other than toner when deriving the estimated life value of the cartridge.	
<b>Use Case</b>	When toner consumption is low (when the life of the Photosensitive Drum or the Developing Assembly decreases faster than that of toner)	
<b>Adj/Set/Operate Method</b>	Enter the setting value, and then press Apply key.	
<b>Display/Adj/Set Range</b>	100 to 200	
<b>Unit</b>	1%	
<b>Default Value</b>	100	

## ■ DSPLY-SW

COPIER (Service mode for copier) &gt; OPTION (Specification setting mode) &gt; DSPLY-SW

<b>CRGLW-LV</b>		<b>ON/OFF ctrdg prep thrshld set scrn dspl</b>
<b>Detail</b>	To set whether to display the screen to set the threshold value for the toner level to prompt preparation of a cartridge. When 1 is set, [Custom] is displayed in [Display Timing for Cartridge Prep. Notif.] so that the user can set the toner level (1 to 99%). When 0 is set, the item is not displayed, so the user cannot set the toner level.	
<b>Adj/Set/Operate Method</b>	Enter the setting value, and then press Apply key.	
<b>Display/Adj/Set Range</b>	0 to 1 0: OFF, 1: ON	
<b>Default Value</b>	1	
<b>Additional Functions Mode</b>	Preferences > Display Settings > Display Timing for Cartridge Prep. Notif.	

## ■ IMG-MCON

COPIER (Service mode for copier) > OPTION (Specification setting mode) > IMG-MCON

<b>TMIC-BK</b>	<b>TMIC Bk PASCAL gamma LUT end edge crrcrct</b>
<b>Detail</b>	To set whether to perform the trailing edge correction of Bk-color PASCAL gamma LUT used by TMIC. When 1 is set, the trailing edge correction is not performed so that density of the high density area becomes high. Consequently, texts and thin lines become clear; however, gradation of photos may become unnatural. When 0 is set, density of the high density area becomes low by the trailing edge correction. Consequently, gradation of photos is improved, but thin lines may be partly missing or texts may be faded.
<b>Use Case</b>	- When gradation of photos become unnatural - When thin lines are partly missing or characters are faded
<b>Adj/Set/Operate Method</b>	Enter the setting value, and then press Apply key.
<b>Display/Adj/Set Range</b>	0 to 1 0: OFF, 1: ON
<b>Default Value</b>	1
<b>Supplement/Memo</b>	TMIC: Error diffusion correction of photo/high image quality.

<b>TMIC-CMY</b>	<b>TMIC Y/M/C PASCAL gamma LUT end correct</b>
<b>Detail</b>	To set whether to perform the trailing edge correction of Y/M/C-color PASCAL gamma LUT used by TMIC. When 1 is set, the trailing edge correction is not performed so that density of the high density area becomes high. Consequently, texts and thin lines become clear; however, gradation of photos may become unnatural. When 0 is set, density of the high density area becomes low by the trailing edge correction. Consequently, gradation of photos is improved, but thin lines may be partly missing or texts may be faded.
<b>Use Case</b>	- When gradation of photos become unnatural - When thin lines are partly missing or characters are faded
<b>Adj/Set/Operate Method</b>	Enter the setting value, and then press Apply key.
<b>Display/Adj/Set Range</b>	0 to 1 0: OFF, 1: ON
<b>Default Value</b>	1
<b>Supplement/Memo</b>	TMIC: Error diffusion correction of photo/high image quality.

## ■ USER

COPIER (Service mode for copier) > OPTION (Specification setting mode) > USER

<b>CTCHKDSP</b>	<b>ON/OFF of charge counter list output</b>
<b>Detail</b>	To set whether to print the charge counter in the system management data list.
<b>Use Case</b>	Upon user's request
<b>Adj/Set/Operate Method</b>	1) Enter the setting value, and then press Apply key. 2) Turn OFF/ON the main power switch.
<b>Display/Adj/Set Range</b>	0 to 1 0: ON, 1: OFF
<b>Default Value</b>	1
<b>Additional Functions Mode</b>	Output Report > Print List > System Manager Data List

COPIER (Service mode for copier) &gt; OPTION (Specification setting mode) &gt; USER

<b>TNRB-SW</b>	<b>ON/OFF of toner replacement counter display</b>
<b>Detail</b>	To set whether to display the toner replacement counter on the Counter Check screen. When 1 is set, the user can check the toner replacement counter.
<b>Use Case</b>	Upon user's request
<b>Adj/Set/Operate Method</b>	1) Enter the setting value, and then press Apply key. 2) Turn OFF/ON the main power switch.
<b>Display/Adj/Set Range</b>	0 to 3 0: Hide 1: Display (Toner replacement counters in the 190s) 2 to 3: Not used
<b>Default Value</b>	0
<b>PS-MODE</b>	<b>Setting of compatible mode at PS usage</b>
<b>Detail</b>	To set the image processing at PS print. Set 8 when line width differs depending on the drawing position although the same line width is set. Setting of a value other than the setting values means that multiple settings are combined. (Example: 12=4+8)
<b>Use Case</b>	Upon user's request
<b>Adj/Set/Operate Method</b>	1) Enter the setting value, and then press Apply key. 2) Turn OFF/ON the main power switch.
<b>Display/Adj/Set Range</b>	0 to 63 4: Compatible with EFI at PS 2-sided delivery 8: strokeadjustment is enabled Any value other than those mentioned above: Not used
<b>Default Value</b>	0
<b>SMD-EXPT</b>	<b>Set of service mode set VL export target</b>
<b>Detail</b>	To set whether to export "service mode data" from remote UI. When 1 is set, "service mode data" is displayed as the target data of export on remote UI. When installing more than 1 machine at the same time, the same service mode data can be registered.
<b>Use Case</b>	When installing more than 1 machine at the same time
<b>Adj/Set/Operate Method</b>	1) Enter the setting value, and then press Apply key. 2) Turn OFF/ON the main power switch.
<b>Display/Adj/Set Range</b>	0 to 1 0: Not targeted 1: Targeted
<b>Default Value</b>	0
<b>Supplement/Memo</b>	If selecting "service mode data" as the target data of export on remote UI after setting SMD-EXPT to 1, service mode data can be exported.
<b>ACC-SLP</b>	<b>Set shift to sleep3: Card Reader connect</b>
<b>Detail</b>	To set whether to shift to sleep mode 3 when the Card Reader is connected.
<b>Adj/Set/Operate Method</b>	Enter the setting value, and then press Apply key.
<b>Display/Adj/Set Range</b>	0 to 1 0: Not shifted 1: Shifted
<b>Default Value</b>	1

COPIER (Service mode for copier) &gt; OPTION (Specification setting mode) &gt; USER

RPL-IMP	ON/OFF of replacement mode
<b>Detail</b>	To set whether to import the setting information of a machine which has been exported to a different one of the same model using DCM function. When 0 is set, the setting information which has been exported can be imported only to the same machine. When 1 is set, the machine-specific setting information such as IPv4 address setting can be imported to a different machine.
<b>Use Case</b>	When migrating the setting of a machine to a different machine of the same series that has been replaced
<b>Display/Adj/Set Range</b>	0 to 1 0: OFF, 1: ON
<b>Default Value</b>	0
<b>Supplement/Memo</b>	DCM (Device Configuration Management): A function to export/import the machine's setting information as a file.

## ■ ACC

COPIER (Service mode for copier) &gt; OPTION (Specification setting mode) &gt; ACC

WLAN	Setting of wireless LAN function
<b>Detail</b>	To set whether to enable the wireless LAN function.
<b>Use Case</b>	Upon user's request
<b>Adj/Set/Operate Method</b>	1) Enter the setting value, and then press Apply key. 2) Turn OFF/ON the main power switch.
<b>Display/Adj/Set Range</b>	0 to 1 0: Disabled 1: Enabled
<b>Default Value</b>	It differs according to the model.
UNIF-OF	Setting of uniFLOW function
<b>Detail</b>	To set whether to enable the uniFLOW function. If 1 is set for this item and power is turned OFF/ON while the uniFLOW function is in operation, the function stops. When the setting value is set to 1, the uniFLOW function is disabled.
<b>Use Case</b>	- When avoiding failure due to error of the uniFLOW function - When connecting to the uniFLOW server is failed due to the error in the machine
<b>Adj/Set/Operate Method</b>	1) Enter the setting value, and then press Apply key. 2) Turn OFF/ON the main power switch.
<b>Caution</b>	Be sure to change the value back to 0 after servicing.
<b>Display/Adj/Set Range</b>	0 to 1 0: Enabled 1: Disabled
<b>Default Value</b>	0

## ■ LCNS-TR

COPIER (Service mode for copier) &gt; OPTION (Specification setting mode) &gt; LCNS-TR

ST-BRDIM	Install state Display of BarDIMM function
<b>Detail</b>	To display installation state of Barcode Printing for PCL when disabling and then transferring the license.
<b>Use Case</b>	When checking whether Barcode Printing for PCL is installed
<b>Adj/Set/Operate Method</b>	1) Select ST-BRDIM. 2) Enter 0, and then press Apply key. When installation has been completed, the transfer license key is displayed under TR-BRDIM.
<b>Default Value</b>	According to the setting at shipment

COPIER (Service mode for copier) &gt; OPTION (Specification setting mode) &gt; LCNS-TR

TR-BRDIM	Trns lcns key Display of BarDIMM function
<b>Detail</b>	To display transfer license key to use Barcode Printing for PCL when disabling and then transferring the license.
<b>Use Case</b>	When replacing the device
<b>Adj/Set/Operate Method</b>	1) Select ST-BRDIM. 2) Enter 0, and then press Apply key. The transfer license key is displayed under TR-BRDIM.
<b>Display/Adj/Set Range</b>	24 digits

## ■ LCNS-OF

COPIER (Service mode for copier) &gt; OPTION (Specification setting mode) &gt; LCNS-OF

ST-BRDIM	Not use
----------	---------

## COUNTER (Counter mode)

### ■ TOTAL

COPIER (Service mode for copier) &gt; COUNTER (Counter mode) &gt; TOTAL

SERVICE1	Service-purposed total counter 1
<b>Detail</b>	To count up when the printout is delivered outside the machine. Large size: 1, Small size: 1 A blank sheet is not counted.
<b>Adj/Set/Operate Method</b>	N/A (Display only)
<b>Display/Adj/Set Range</b>	0 to 99999999
<b>Unit</b>	1 sheet
<b>Default Value</b>	0
SERVICE2	Service-purposed total counter 2
<b>Detail</b>	To count up when the printout is delivered outside the machine. Large size: 2, Small size: 1 A blank sheet is not counted.
<b>Adj/Set/Operate Method</b>	N/A (Display only)
<b>Display/Adj/Set Range</b>	0 to 99999999
<b>Unit</b>	1 sheet
<b>Default Value</b>	0
TTL	Total counter
<b>Detail</b>	To display the total of counters of COPY, PDL-PRT, FAX-PRT, RPT-PRT, and MD-PRT.
<b>Adj/Set/Operate Method</b>	N/A (Display only)
<b>Display/Adj/Set Range</b>	0 to 99999999
<b>Unit</b>	1 sheet
<b>Default Value</b>	0
<b>Related Service Mode</b>	COPIER> COUNTER> TOTAL> COPY, PDL-PRT, FAX-PRT, RPT-PRT, MD-PRT
PDL-PRT	PDL print counter
<b>Detail</b>	To count up when the printout is delivered outside the machine/2-sided printout is stacked according to the charge counter at PDL print. Large size: 1, Small size: 1 A blank sheet is not counted.
<b>Adj/Set/Operate Method</b>	N/A (Display only)
<b>Display/Adj/Set Range</b>	0 to 99999999
<b>Unit</b>	1 sheet
<b>Default Value</b>	0

COPIER (Service mode for copier) &gt; COUNTER (Counter mode) &gt; TOTAL

<b>FAX-PRT</b>	<b>FAX reception print counter</b>
<b>Detail</b>	To count up when the FAX reception print is delivered outside the machine/2-sided printout is stacked. Large size: 1, Small size: 1 The counter is not advanced by blank paper or delivery in service mode.
<b>Adj/Set/Operate Method</b>	N/A (Display only)
<b>Display/Adj/Set Range</b>	0 to 99999999
<b>Unit</b>	1 sheet
<b>Default Value</b>	0
<b>Related Service Mode</b>	COPIER> COUNTER> TOTAL> TTL
<b>Supplement/Memo</b>	FAX model only

<b>RPT-PRT</b>	<b>Report print counter</b>
<b>Detail</b>	To count up when the report print is delivered outside the machine/2-sided printout is stacked. Large size: 1, Small size: 1 The counter is not advanced by blank paper or delivery in service mode.
<b>Adj/Set/Operate Method</b>	N/A (Display only)
<b>Display/Adj/Set Range</b>	0 to 99999999
<b>Unit</b>	1 sheet
<b>Default Value</b>	0
<b>Related Service Mode</b>	COPIER> COUNTER> TOTAL> TTL

<b>MD-PRT</b>	<b>Media print counter</b>
<b>Detail</b>	To count up when the media print is delivered outside the machine. Large size: 1, Small size: 1 The counter is not advanced by blank paper or delivery in service mode.
<b>Adj/Set/Operate Method</b>	N/A (Display only)
<b>Display/Adj/Set Range</b>	0 to 99999999
<b>Unit</b>	1 sheet
<b>Default Value</b>	0
<b>Related Service Mode</b>	COPIER> COUNTER> TOTAL> TTL

## ■ PICK-UP

COPIER (Service mode for copier) &gt; COUNTER (Counter mode) &gt; PICK-UP

<b>C1</b>	<b>Cassette 1 pickup total counter</b>
<b>Detail</b>	To count up the number of sheets picked up from the Cassette 1. Large size: 1, Small size: 1 The counter is advanced by printout in service mode.
<b>Adj/Set/Operate Method</b>	N/A (Display only)
<b>Display/Adj/Set Range</b>	0 to 99999999
<b>Unit</b>	1 sheet
<b>Default Value</b>	0

<b>C2</b>	<b>Cassette 2 pickup total counter</b>
<b>Detail</b>	To count up the number of sheets picked up from the Cassette 2. Large size: 1, Small size: 1 The counter is advanced by printout in service mode.
<b>Adj/Set/Operate Method</b>	N/A (Display only)
<b>Display/Adj/Set Range</b>	0 to 99999999
<b>Unit</b>	1 sheet
<b>Default Value</b>	0



COPIER (Service mode for copier) &gt; COUNTER (Counter mode) &gt; PICK-UP

MF	Multi-purpose Tray pickup total counter
<b>Detail</b>	To count up the number of sheets picked up from the Multi-purpose Tray Pickup Unit. Large size: 1, Small size: 1 The counter is advanced by printout in service mode.
<b>Adj/Set/Operate Method</b>	N/A (Display only)
<b>Display/Adj/Set Range</b>	0 to 99999999
<b>Unit</b>	1 sheet
<b>Default Value</b>	0

2-SIDE	2-sided pickup total counter
<b>Detail</b>	To count up the number of sheets picked up in duplex mode. Large size: 1, Small size: 1 The counter is advanced by printout in service mode.
<b>Adj/Set/Operate Method</b>	N/A (Display only)
<b>Display/Adj/Set Range</b>	0 to 99999999
<b>Unit</b>	1 sheet
<b>Default Value</b>	0

## ■ JAM

COPIER (Service mode for copier) &gt; COUNTER (Counter mode) &gt; JAM

TOTAL	Total jam counter
<b>Detail</b>	To count up the number of total jam occurrences.
<b>Use Case</b>	When checking the jam counter
<b>Adj/Set/Operate Method</b>	N/A (Display only)
<b>Display/Adj/Set Range</b>	0 to 99999999
<b>Unit</b>	1 time
<b>Default Value</b>	0

2-SIDE	Duplex Unit jam counter
<b>Detail</b>	To count up the number of jam occurrences in the Duplex Unit.
<b>Use Case</b>	When checking the jam counter
<b>Adj/Set/Operate Method</b>	N/A (Display only)
<b>Display/Adj/Set Range</b>	0 to 99999999
<b>Unit</b>	1 time
<b>Default Value</b>	0

MF	Multi-purpose Tray jam counter
<b>Detail</b>	To count up the number of jam occurrences in the Multi-purpose Tray. The counter is advanced even in the case of paper size mismatch or misprint.
<b>Use Case</b>	When checking the jam counter
<b>Adj/Set/Operate Method</b>	N/A (Display only)
<b>Display/Adj/Set Range</b>	0 to 99999999
<b>Unit</b>	1 time
<b>Default Value</b>	0

COPIER (Service mode for copier) &gt; COUNTER (Counter mode) &gt; JAM

<b>C1</b>		<b>Cassette 1 jam counter</b>
<b>Detail</b>	To count up the number of jam occurrences in the Cassette 1. The counter is advanced even in the case of paper size mismatch or misprint.	
<b>Use Case</b>	When checking the jam counter	
<b>Adj/Set/Operate Method</b>	N/A (Display only)	
<b>Display/Adj/Set Range</b>	0 to 99999999	
<b>Unit</b>	1 time	
<b>Default Value</b>	0	
<b>C2</b>		<b>Cassette 2 jam counter</b>
<b>Detail</b>	To count up the number of jam occurrences in the Cassette 2. The counter is advanced even in the case of paper size mismatch or misprint.	
<b>Use Case</b>	When checking the jam counter	
<b>Adj/Set/Operate Method</b>	N/A (Display only)	
<b>Display/Adj/Set Range</b>	0 to 99999999	
<b>Unit</b>	1 time	
<b>Default Value</b>	0	

## TESTMODE (Service mode for test print, operation check, etc.)

### PRINT (Print test mode)

TESTMODE (Service mode for test print, operation check, etc.) > PRINT (Print test mode)

PG-TYPE		Setting of PG number
	<b>Detail</b>	To set the PG number of the test print.
	<b>Use Case</b>	At trouble analysis
	<b>Adj/Set/Operate Method</b>	Enter the setting value, and then press Apply key.
	<b>Display/Adj/Set Range</b>	0 to 26 0 to 1: For R&D use 2: Color chart 3: For R&D use 4: Rainbow chart (vertical scanning direction, A4) 5: Rainbow chart (horizontal scanning direction, A4) 6: Color grid (A4) 7: Rainbow chart (vertical scanning direction, LTR/LGL) 8: Rainbow chart (horizontal scanning direction, LTR/LGL) 9: Color grid (LTR/LGL) 10: 16 gradations 11: 17 gradations of Y/M/C/Bk/R/G/B 12: Halftone 13: For checking ghost due to transfer failure 14: For checking the density patch 15: For checking transfer 20: For R&D use 21: For checking developing performance (white spots) 22: For checking resolution 23: For checking banding image 24: 4 colors (landscape) 25: 4 colors (portrait) 26: For calibrating color difference between the front and back sides with DADF (1-path model)
	<b>Default Value</b>	0
COUNT		Setting of PG output quantity
	<b>Detail</b>	To set the number of sheets for PG output.
	<b>Use Case</b>	At trouble analysis
	<b>Adj/Set/Operate Method</b>	Enter the setting value, and then press Apply key.
	<b>Display/Adj/Set Range</b>	1 to 99
	<b>Unit</b>	1 sheet
	<b>Default Value</b>	1
PHASE		Set 1-sided/2-sided print for PG output
	<b>Detail</b>	To set 1-sided/2-sided print for PG output. Even if 1 is set for a machine supporting 1-sided print, the setting is disabled.
	<b>Use Case</b>	At trouble analysis
	<b>Adj/Set/Operate Method</b>	Enter the setting value, and then press Apply key.
	<b>Display/Adj/Set Range</b>	0 to 1 0: 1-sided 1: 2-sided
	<b>Default Value</b>	0

TESTMODE (Service mode for test print, operation check, etc.) > PRINT (Print test mode)

MODE		Setting of test print image formation method
	<b>Detail</b>	To set the image formation method for the test print. If PG-TYPE is 0 or 1, this setting is disabled because a specific image formation method is applied.
	<b>Use Case</b>	At trouble analysis
	<b>Adj/Set/Operate Method</b>	Enter the setting value, and then press Apply key.
	<b>Display/Adj/Set Range</b>	0 to 3 0: T-MIC 1: High screen ruling (SCA) 2: Low screen ruling (SCB) 3: TBIC
	<b>Default Value</b>	0
	<b>Related Service Mode</b>	TESTMODE> PRINT> PG-TYPE
THRU		Setting of image correction table at test print
	<b>Detail</b>	To set the image correction table that is used at the time of test print output. When 0 is set, normal gamma LUT is used so that the density characteristics by the density correction process can be checked. When 1 is set, linear gamma LUT is used so that the density characteristics of this machine can be checked. When 2 is set, the high density area of Bk-color is printed darker.
	<b>Use Case</b>	At trouble analysis
	<b>Adj/Set/Operate Method</b>	Enter the setting value, and then press Apply key.
	<b>Display/Adj/Set Range</b>	0 to 2 0: Normal gamma LUT 1: Through (linear) gamma LUT 2: With trailing edge correction of Bk-color
	<b>Default Value</b>	0
	<b>Supplement/Memo</b>	Gamma LUT: Density gradation characteristic table
NRKE		ON/OFF of laser scanning transfer process of test print
	<b>Detail</b>	To set whether to perform line transfer process for skew correction of laser scanning at test print.
	<b>Use Case</b>	At trouble analysis
	<b>Adj/Set/Operate Method</b>	Enter the setting value, and then press Apply key.
	<b>Display/Adj/Set Range</b>	0 to 1 0: OFF 1: ON
	<b>Default Value</b>	0
	<b>Supplement/Memo</b>	Transfer process: A process to correct skew of laser scanning toward vertical scanning direction
BLND		ON/OFF of interpolation process at test print
	<b>Detail</b>	To set whether to perform interpolation process at test print. When 1 is set, interpolation process is performed (no phase shift).
	<b>Use Case</b>	At trouble analysis
	<b>Adj/Set/Operate Method</b>	Enter the setting value, and then press Apply key.
	<b>Display/Adj/Set Range</b>	0 to 1 0: OFF 1: ON
	<b>Default Value</b>	0
	<b>Supplement/Memo</b>	Interpolation process: A process to predict, for pixels holding no color information, color based on the surrounding pixels, and then set up the color information.

TESTMODE (Service mode for test print, operation check, etc.) > PRINT (Print test mode)

<b>DENS-Y</b>	<b>Adj of Y-color density at test print</b>
<b>Detail</b>	To adjust Y-color density when performing test print . As the value is larger, the image gets darker.
<b>Use Case</b>	At test print
<b>Adj/Set/Operate Method</b>	Enter the setting value, and then press Apply key.
<b>Display/Adj/Set Range</b>	0 to 255
<b>Default Value</b>	128
<b>Related Service Mode</b>	TESTMODE> PRINT> PG-TYPE
<b>DENS-M</b>	<b>Adj of M-color density at test print</b>
<b>Detail</b>	To adjust M-color density when performing test print . As the value is larger, the image gets darker.
<b>Use Case</b>	At test print
<b>Adj/Set/Operate Method</b>	Enter the setting value, and then press Apply key.
<b>Display/Adj/Set Range</b>	0 to 255
<b>Default Value</b>	128
<b>Related Service Mode</b>	TESTMODE> PRINT> PG-TYPE
<b>DENS-C</b>	<b>Adj of C-color density at test print</b>
<b>Detail</b>	To adjust C-color density when performing test print . As the value is larger, the image gets darker.
<b>Use Case</b>	At test print
<b>Adj/Set/Operate Method</b>	Enter the setting value, and then press Apply key.
<b>Display/Adj/Set Range</b>	0 to 255
<b>Default Value</b>	128
<b>Related Service Mode</b>	TESTMODE> PRINT> PG-TYPE
<b>DENS-K</b>	<b>Adj of Bk-color density at test print</b>
<b>Detail</b>	To adjust Bk-color density when performing test print . As the value is larger, the image gets darker.
<b>Use Case</b>	At test print
<b>Adj/Set/Operate Method</b>	Enter the setting value, and then press Apply key.
<b>Display/Adj/Set Range</b>	0 to 255
<b>Default Value</b>	128
<b>Related Service Mode</b>	TESTMODE> PRINT> PG-TYPE
<b>SW-Y</b>	<b>ON/OFF of Y-color output at test print</b>
<b>Detail</b>	To set whether to output Y-color at the time of test print .
<b>Use Case</b>	At test print
<b>Adj/Set/Operate Method</b>	Enter the setting value, and then press Apply key.
<b>Display/Adj/Set Range</b>	0 to 1 0: OFF, 1: ON
<b>Default Value</b>	1
<b>Related Service Mode</b>	TESTMODE> PRINT> PG-TYPE
<b>SW-M</b>	<b>ON/OFF of M-color output at test print</b>
<b>Detail</b>	To set whether to output M-color at the time of test print .
<b>Use Case</b>	At test print
<b>Adj/Set/Operate Method</b>	Enter the setting value, and then press Apply key.
<b>Display/Adj/Set Range</b>	0 to 1 0: OFF, 1: ON
<b>Default Value</b>	1

TESTMODE (Service mode for test print, operation check, etc.) > PRINT (Print test mode)

<b>SW-C</b>	<b>ON/OFF of C-color output at test print</b>
<b>Detail</b>	To set whether to output C-color at the time of test print .
<b>Use Case</b>	At test print
<b>Adj/Set/Operate Method</b>	Enter the setting value, and then press Apply key.
<b>Display/Adj/Set Range</b>	0 to 1 0: OFF, 1: ON
<b>Default Value</b>	1
<b>SW-K</b>	<b>ON/OFF of Bk-color output at test print</b>
<b>Detail</b>	To set whether to output Bk-color at the time of test print .
<b>Use Case</b>	At test print
<b>Adj/Set/Operate Method</b>	Enter the setting value, and then press Apply key.
<b>Display/Adj/Set Range</b>	0 to 1 0: OFF, 1: ON
<b>Default Value</b>	1
<b>MONOMODE</b>	<b>ON/OFF of black mode at test print</b>
<b>Detail</b>	To set whether to enable black mode at the time of test print.
<b>Use Case</b>	At test print
<b>Adj/Set/Operate Method</b>	Enter the setting value, and then press Apply key.
<b>Display/Adj/Set Range</b>	0 to 1 0: OFF, 1: ON
<b>Default Value</b>	0
<b>FEED</b>	<b>Setting of paper source at test print</b>
<b>Detail</b>	To set the paper source at the time of test print output. If this mode is set when there is no Cassette 2 (option Pickup Cassette), the output is made from Cassette 1 (standard Pickup Cassette).
<b>Use Case</b>	At trouble analysis
<b>Adj/Set/Operate Method</b>	Enter the setting value, and then press Apply key.
<b>Caution</b>	In case of using the Multi-purpose Tray, be sure to place paper on the tray before executing this item.
<b>Display/Adj/Set Range</b>	0 to 4 0: Multi-purpose Tray 1: Cassette 1 2: Cassette 2 3: Cassette 3 4: Cassette 4
<b>Default Value</b>	1
<b>START</b>	<b>Output of test print</b>
<b>Detail</b>	To output a test print with the PG pattern set in PG-TYPE, MODE, etc.
<b>Use Case</b>	At trouble analysis
<b>Adj/Set/Operate Method</b>	Select the item, and then press Yes key.
<b>Related Service Mode</b>	TESTMODE> PRINT

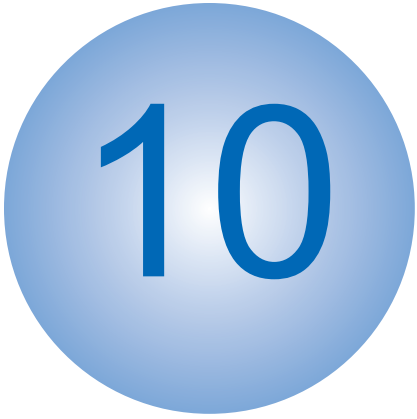

# Installation

MiCARD Attachment Kit-B1..... 208

## MiCARD Attachment Kit-B1

### Points to Note at Installation

Prepare a Card Reader (sales company's option) in advance. Although the shape of the Card Reader may differ, the installation procedure is the same. Use the short-type Card Reader Cable.

### Installation Outline Drawing

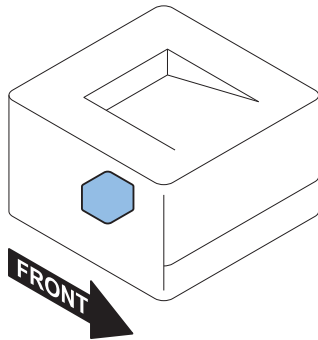

### Checking the Contents

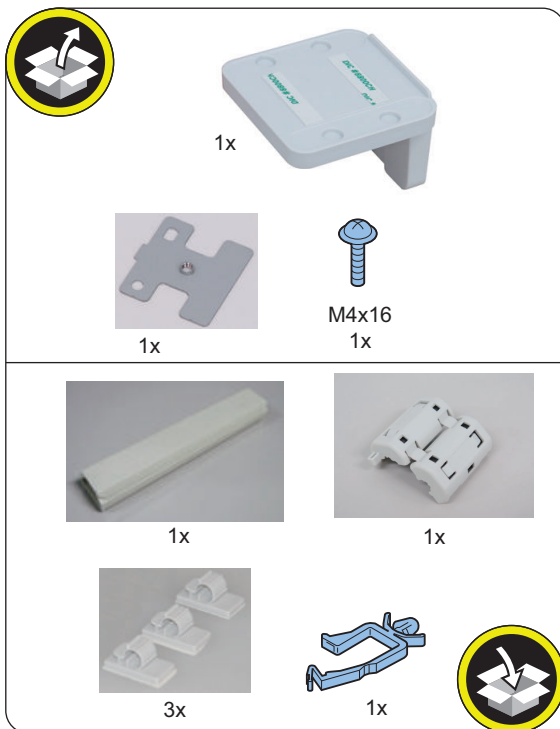

### Check Item When Turning OFF the Main Power

Check that the main power is OFF.

1. Turn OFF the main power switch.

2. Check that the display in the Control Panel and the lamp of the main power are turned off, and then disconnect the power plug.

### Installation Procedure

□  
1.

#### NOTE:

Shift the host machine by approximately 80 mm from the working table to release the claws on the bottom of the Left Cover.

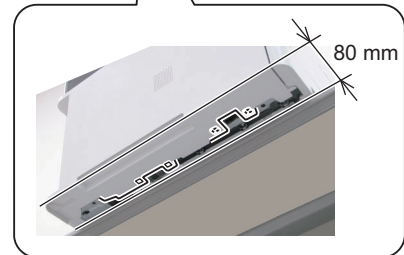
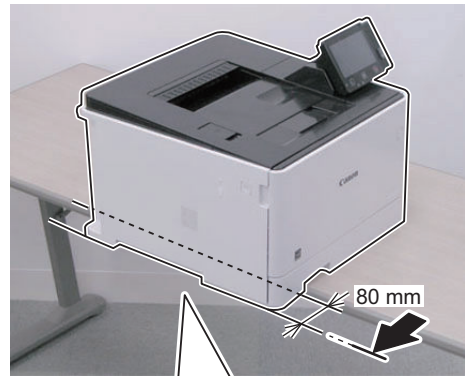



□  
2.

**⚠ CAUTION:**

Do not completely pull out the cassette, as doing so will disturb the balance of the product and may cause it to fall down.

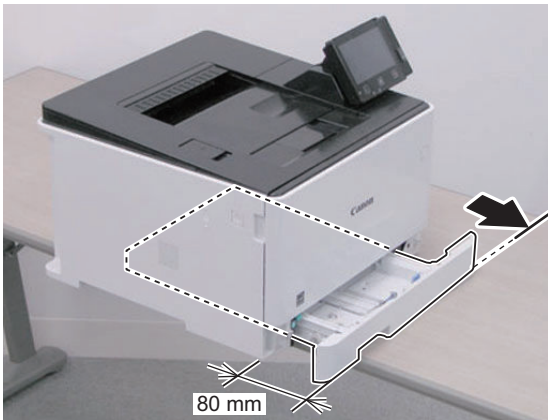

□  
3.

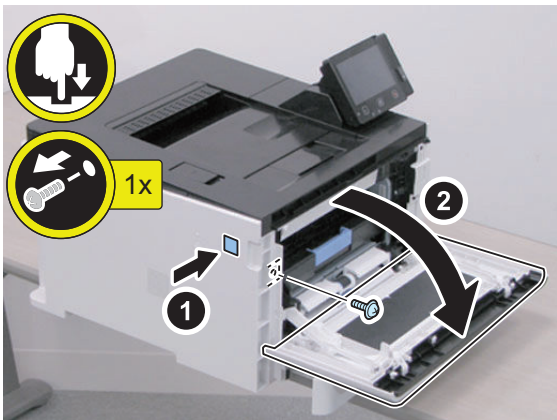

□  
4.

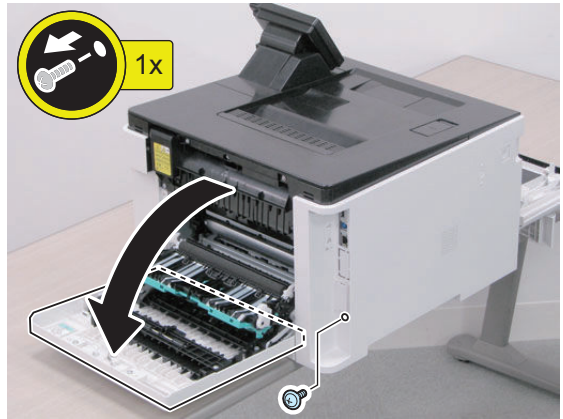

5.

**CAUTION:**

Be sure to free the bosses while holding the joint because the Cartridge Cover Retainer comes off easily.

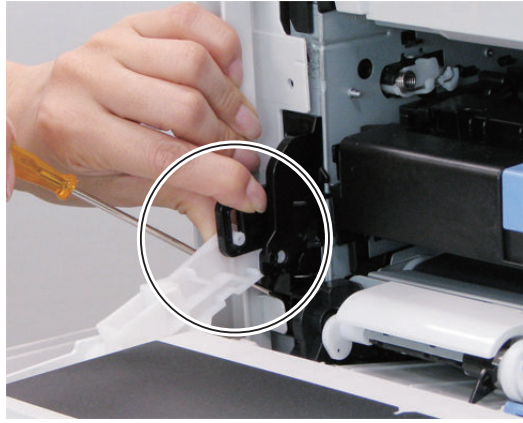

**NOTE:**

The bosses can be freed easily by pulling the Left Cover in the [A] direction and pulling the Cartridge Cover Retainer in the [B] direction.

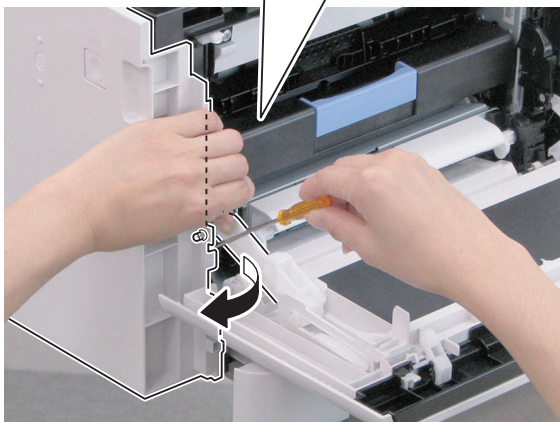
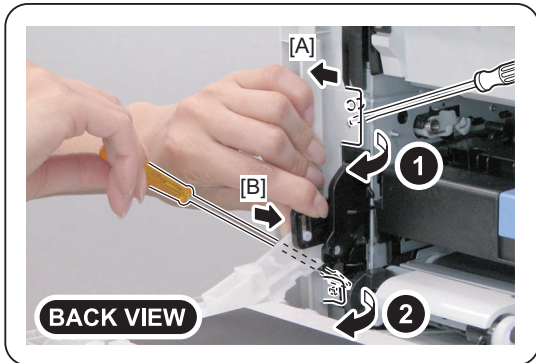

6.

**NOTE:**

Release the claw while opening the Left Cover Unit in the direction of the arrow.

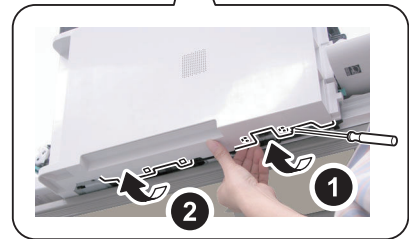
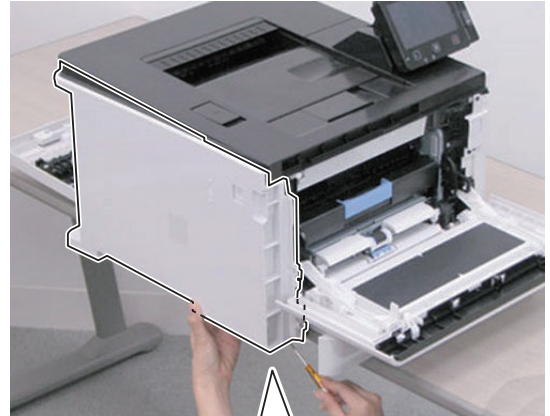

7.



8.

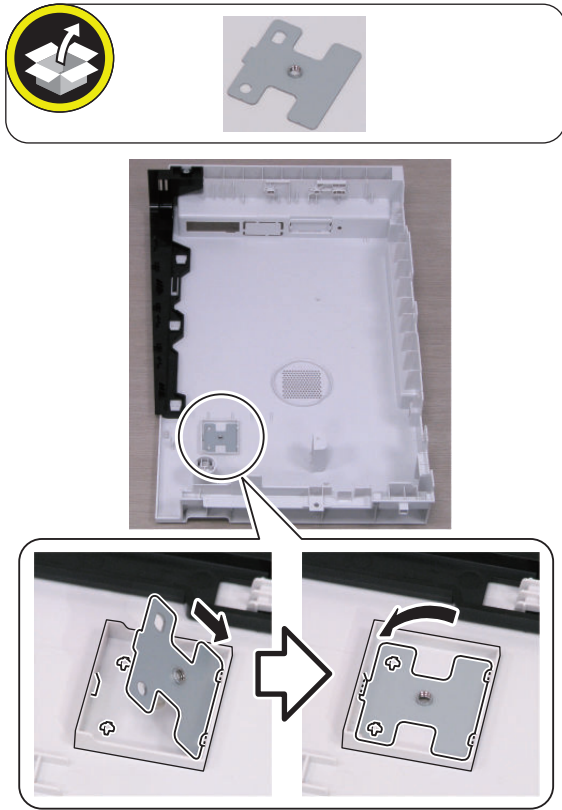

9.

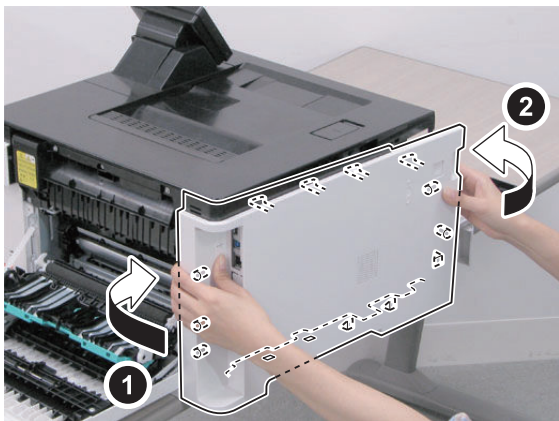

10.

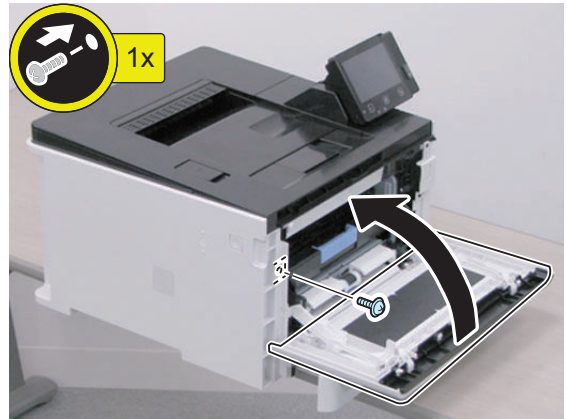

11.



12.

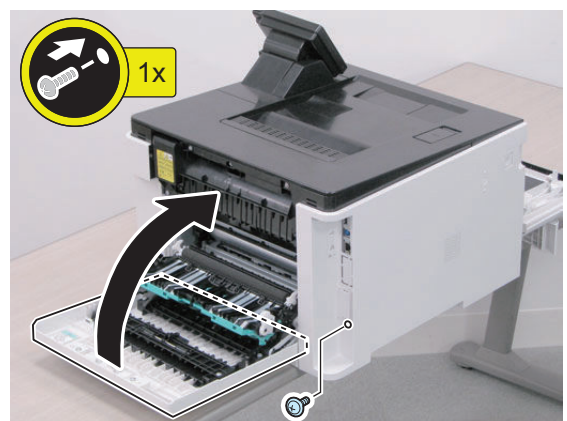

□  
**13.**

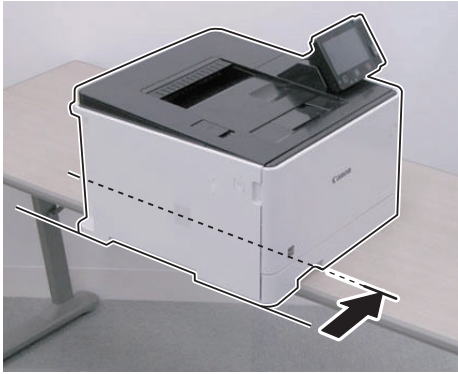

□  
**16.**

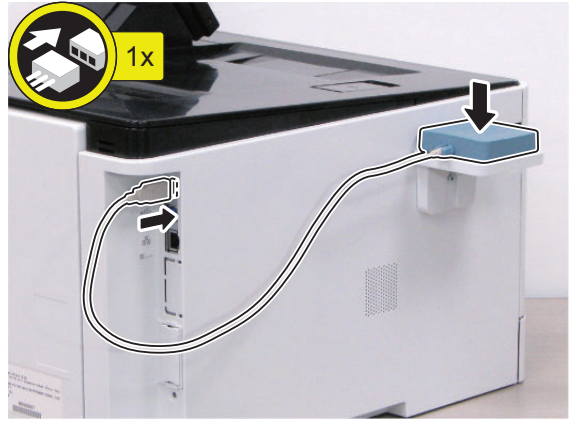

□  
**14.**

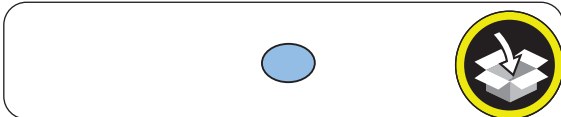
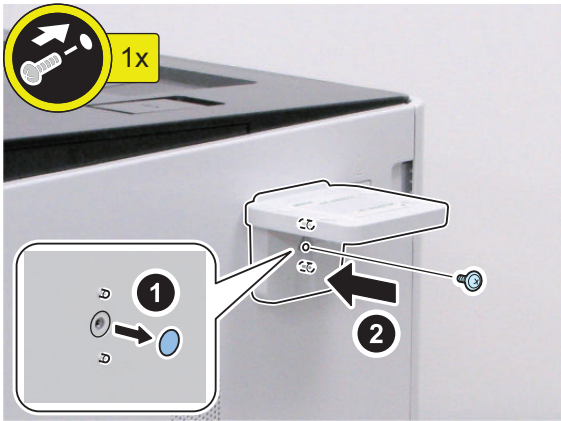

□  
**15.**



□

**17.** Connect the power plug to the outlet.

**18.** Turn ON the main power switch.

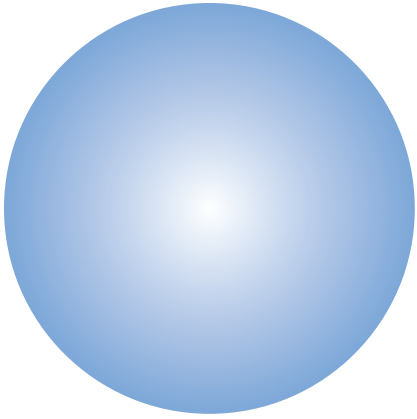

# APPENDICES

Service Tools.....	214
General Circuit Diagram.....	215
Backup Data List.....	217
Soft counter specifications.....	219

## Service Tools

### Special Tools

In addition to the standard tools set, the following special tools are required when servicing the machine:

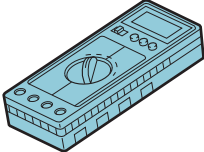
Name of Tool	Parts.No	Use
Digital Multimeter	FY9-2002	Used as a probe extension when making electrical checks. 

### Solvents and Oil List

No.	Type	Purpose	Remark
1	Ethyl alcohol	<ul style="list-style-type: none"> <li>Cleaning: metal part, oil stains, toner stains</li> </ul>	<ul style="list-style-type: none"> <li>Purchase locally</li> <li>Keep away from flame</li> </ul>

# General Circuit Diagram

General Circuit Diagram(1/2)

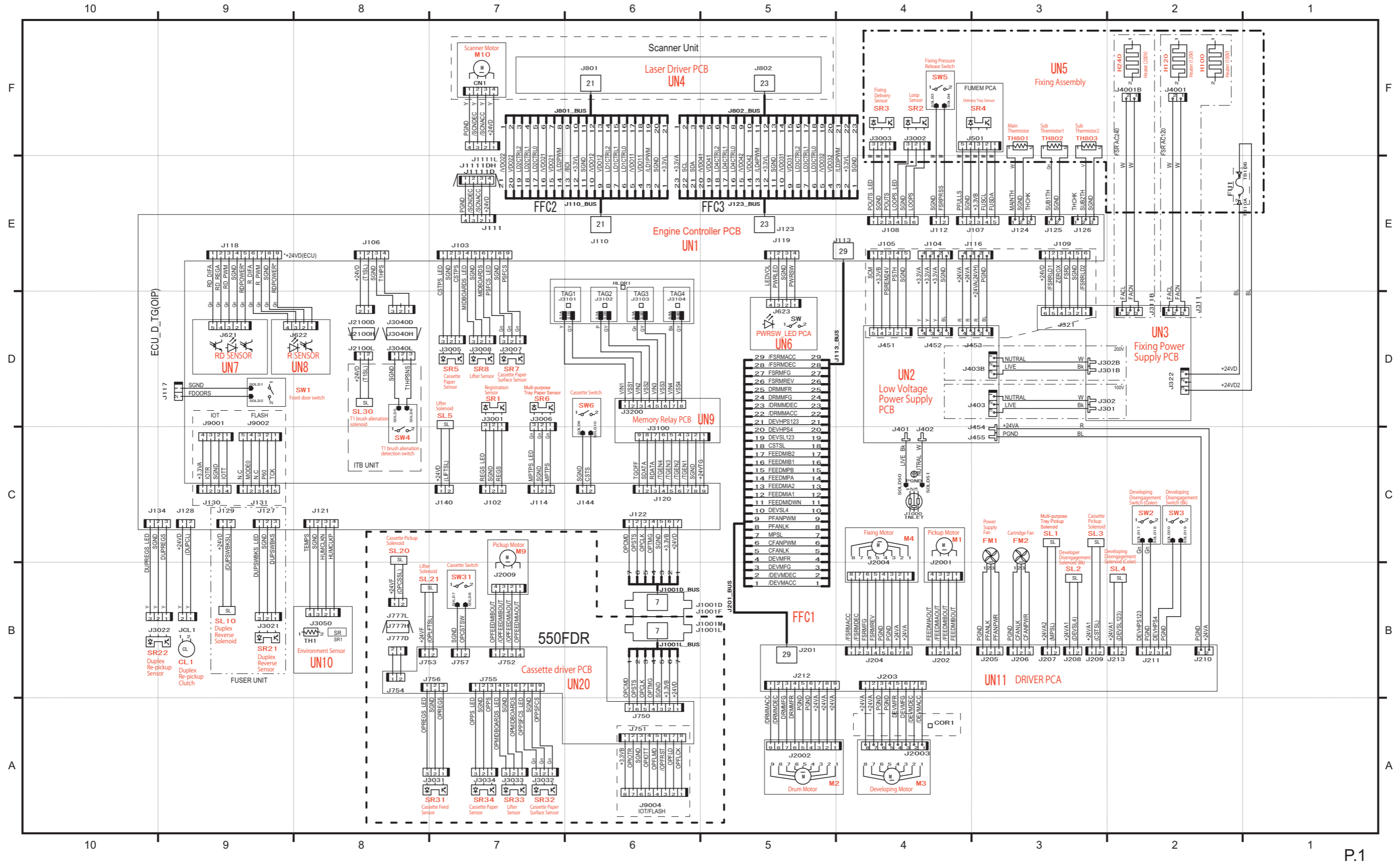





# Backup Data List

Data	Location	Replace		Delete																Backup by User			Backup by Service		
				Menu > System Management Settings								Service Mode > COPIER > FUNCTION >													
		Engine Controller PCB	Main Controller PCB	Initialize All Data / Settings	Initializing Key and Certificate	Initializing Address Book	Menu Clear				CLEAR				SPLMAN	Yes/No	Method	Location to be stored	Yes/No	Method	Location to be stored				
							Preferences	Function Settings	Set Destination	Management Settings	Network Settings	Clear All	SRVCDAT*1	COUNTER								HIST *2	ALL	PLPW-CLR	DC-CON
Address Book	Main Controller PCB	-	Clear	Clear	-	Clear	-	-	-	-	-	-	-	-	Clear	-	-	-	Yes	Remote UI *5 LUI *6	PC, USB memory	No	-	-	
Settings Menu																									
Preferences	Main Controller PCB	-	Clear	Clear	-	-	Clear*8	-	-	-	Clear*9	Clear	-	-	-	Clear	-	-	-	Yes	Remote UI *5 LUI *6	PC, USB memory	No	-	-
Function Settings	Main Controller PCB	-	Clear	Clear	-	-	-	Clear	-	-	-	Clear	-	-	-	Clear	-	-	-	Yes	Remote UI *5 LUI *6	PC, USB memory	No	-	-
Set Destination	Main Controller PCB	-	Clear	Clear	-	-	-	-	Clear	-	-	Clear	-	-	-	Clear	-	-	-	Yes	Remote UI *5 LUI *6	PC, USB memory	No	-	-
Management Settings	Main Controller PCB	-	Clear	Clear	-	-	-	-	-	Clear	-	Clear	-	-	-	Clear	-	-	-	Yes	Remote UI *5 LUI *6	PC, USB memory	No	-	-
Status Monitor/Cancel																									
Job Log	Main Controller PCB	-	Clear	Clear	-	-	-	-	-	-	-	-	-	-	Clear	Clear	-	-	-	No	-	-	No	-	-
Counter																									
Part counter (Main Controller)	Main Controller PCB	-	Clear	Clear	-	-	-	-	-	-	-	-	-	Clear	-	-	-	-	-	No	-	-	No	-	-
Part counter (DC Controller)	Engine Controller PCB	Clear	-	-	-	-	-	-	-	-	-	-	-	-	-	-	-	-	-	No	-	-	No	-	-
Other																									
Key and Certificate Settings	Main Controller PCB	-	Clear	Clear	Clear	-	-	-	-	-	-	-	-	-	Clear	-	-	-	-	No	-	-	No	-	-
Service mode																									
Service mode setting values (Main Controller)	Main Controller PCB	-	Clear	-	-	-	-	-	-	-	-	-	Clear	-	-	Clear	-	-	-	Yes	Remote UI *5 LUI *6	PC, USB memory	Yes	Service mode *4	USB memory
Service mode setting values (DC Controller)	Engine Controller PCB	Clear	-	-	-	-	-	-	-	-	-	-	-	-	-	-	Clear	-	-	Yes	Remote UI *5 LUI *6	PC, USB memory	Yes	Service mode *4 *7	USB memory / Main Controller
Password																									

Data	Location	Replace		Delete															Backup by User			Backup by Service			
				Menu > System Management Settings								Service Mode > COPIER > FUNCTION >													
		Engine Control-ler PCB	Main Control-ler PCB	Initialize All Data / Settings	Initializ-ing Key and Cer-tificate	Initializ-ing Ad-dress Book	Menu Clear					CLEAR					SPLMAN	Yes/No	Method	Location to be stor-ed	Yes/No	Method	Location to be stor-ed		
							Preferen-ces	Function Settings	Set Desti-nation	Manage-ment Set-tings	Network Settings	Clear All	SRVC-DAT*1	COUN-TER	HIST *2	ALL								PLPW-CLR	DC-CON
System Adminis-trator password	Main Controller PCB	-	Clear*3	Clear*3	-	-	-	-	-	Clear*3	-	Clear*3	-	-	-	Clear*3	-	-	Clear*10	No	-	-	No	-	-
Security Policy Ad-ministra-tor pass-word	Main Controller PCB	-	Clear	Clear	-	-	-	-	-	Clear	-	Clear	-	-	-	Clear	Clear	-	-	No	-	-	No	-	-
Service Mode pass-word*11	Main Controller PCB	-	Clear	Clear	-	-	-	-	-	-	-	-	-	-	-	-	-	-	-	No	-	-	No	-	-

\*1. Service data (Except "COPIER > COUNTER" and "COPIER > FEED-ADJ") are cleared. The factory adjustment values of the Reader and ADF are not initialized.

\*2. Service data is cleared. User data is not cleared. The factory adjustment values of the Reader and ADF are not initialized.

\*3. In the counter meter-installed model: The user data and service data and each history and the settings of the system administrator are cleared. (The system manager ID and password are changed back to the default values ID: 7654321/PWD: 7654321)  
The factory adjustment values of the Reader and ADF are not initialized.

\*4. COPIER > FUNCTION > SYSTEM > IMPORT / COPIER > FUNCTION > SYSTEM > EXPORT

\*5. Settings/Registration >Management Settings >Data Management > Import/Export

\*6. Settings Manu > Management Settings > Data Management > Import/Export

\*7. COPIER > FUNCTION > VIFFNC > STOR-DCN

\*8. Except "Preferences > Network Settings"

\*9. Clear only an item of the "Preferences > Network Settings".

\*10. Because the settings of the "System Manager ID and PIN" are cleared, set "System Manager ID and PIN" again.

\*11. COPIER > OPTION > BODY > SM-PSWD(Setup password by SM-PSWD)

## Soft counter specifications

The numbers entered for software counters are classified as follows:

No.	Counter Details
100 to 199	Total
300 to 399	Print

### 100 to 199

No.	Counter Name
101	Total 1
108	Total (Black1)
113	Total (Black / Small)
114	Total 1 (2-Sided)
123	Total (full color +mono color /small)
149	Total A (full color +mono color 1)
191	Toner replacement /Yellow
192	Toner replacement /Magenta
193	Toner replacement /Cyan
194	Toner replacement /Black

### 300 to 399

No.	Counter Name
322	Print (full color +mono color /small)