



RICOH UNIVERSITY

Learning ♦ Knowledge ♦ Performance



**M199/M200/M203/M204**  
**SERVICE MANUAL**

**LANIER RICOH SAVIN**

It is the reader's responsibility when discussing the information contained within this document to maintain a level of confidentiality that is in the best interest of Ricoh Americas Corporation and its member companies.

***NO PART OF THIS DOCUMENT MAY BE REPRODUCED IN ANY FASHION AND DISTRIBUTED WITHOUT THE PRIOR PERMISSION OF RICOH AMERICAS CORPORATION.***

All product names, domain names or product illustrations, including desktop images, used in this document are trademarks, registered trademarks or the property of their respective companies.

They are used throughout this book in an informational or editorial fashion only and for the benefit of such companies. No such use, or the use of any trade name, or web site is intended to convey endorsement or other affiliation with Ricoh products.

## **WARNING**

*The Service Manual contains information regarding service techniques, procedures, processes and spare parts of office equipment distributed by Ricoh Americas Corporation. Users of this manual should be either service trained or certified by successfully completing a Ricoh Technical Training Program.*

*Untrained and uncertified users utilizing information contained in this service manual to repair or modify Ricoh equipment risk personal injury, damage to property or loss of warranty protection.*

*Ricoh Americas Corporation*

# LEGEND

PRODUCT CODE	COMPANY		
	LANIER	RICOH	SAVIN
M199	N/A	SP C250DN	N/A
M200	SP C252DN	SP C252DN	SP C252DN
M203	N/A	SP C250SF	N/A
M204	SP C250SF	SP C250SF	SP C250SF

# DOCUMENTATION HISTORY

REV. NO.	DATE	COMMENTS
*	04/2014	Original Printing

# M199/M200/M203/M204

## TABLE OF CONTENTS

<b>1. PRODUCT INFORMATION</b> .....	<b>1-1</b>
1.1 MACHINE OVERVIEW .....	1-1
1.1.1 COMPONENT LAYOUT .....	1-1
Engine (M199/M200).....	1-1
Engine (M203/M204).....	1-2
ADF (only for M203/M204).....	1-3
Scanner (only for M203/M204).....	1-3
1.1.2 PAPER PATH.....	1-4
ADF (only for M203/M204).....	1-4
1.1.3 DRIVE LAYOUT .....	1-5
1.2 MACHINE CONFIGURATION .....	1-7
1.2.1 PRINTER MODEL (M199/M200) .....	1-7
1.2.2 MF MODEL (M203/M204).....	1-7
1.3 GUIDANCE FOR THOSE WHO ARE FAMILIAR WITH PREDECESSOR PRODUCTS.....	1-8
1.3.1 PRINTER MODELS: .....	1-8
1.3.2 MF MODELS: .....	1-8
<b>2. INSTALLATION</b> .....	<b>2-1</b>
2.1 INSTALLATION REQUIREMENTS.....	2-1
2.1.1 ENVIRONMENT .....	2-1
2.1.2 MACHINE LEVEL .....	2-1
2.1.3 MACHINE SPACE REQUIREMENTS .....	2-2
Printer Models (M199/M200).....	2-2
MF Models (M203/M204) .....	2-3
2.1.4 POWER REQUIREMENTS .....	2-3
2.1.5 INSTALLATION PROCEDURE .....	2-3
<b>3. REPLACEMENT AND ADJUSTMENT</b> .....	<b>3-1</b>
3.1 BEFORE YOU START.....	3-1
3.1.1 GENERAL PRECAUTIONS.....	3-1
AIO.....	3-1
Laser Unit.....	3-2
Transfer Roller .....	3-2
Fusing .....	3-2

Paper Feed .....	3-2
Scanner Unit (for M203/M204) .....	3-3
3.1.2 RELEASING PLASTIC LATCHES .....	3-3
3.1.3 AFTER SERVICING THE MACHINE .....	3-4
3.1.4 LITHIUM BATTERIES (MF MODELS) .....	3-4
3.2 SPECIAL TOOLS .....	3-5
3.3 EXTERIOR COVERS .....	3-6
3.3.1 REAR COVER .....	3-6
Rear Cover (Printer Models) .....	3-6
Rear Cover (MF Models) .....	3-7
3.3.2 RIGHT COVER .....	3-8
3.3.3 LEFT COVER .....	3-8
Printer Models .....	3-8
MF Models .....	3-9
3.3.4 FRONT COVER UNIT .....	3-10
3.4 SCANNER UNIT (ONLY FOR MF MODELS) .....	3-11
3.4.1 SCANNER UNIT .....	3-11
3.5 ADF (ONLY FOR MF MODELS) .....	3-14
3.5.1 ADF UNIT .....	3-14
3.5.2 ORIGINAL TRAY .....	3-14
3.5.3 ADF PICK-UP ROLLER .....	3-15
3.5.4 ADF FEED ROLLER .....	3-16
3.5.5 ADF SEPARATION PAD .....	3-16
3.5.6 ADF FRONT COVER .....	3-17
3.5.7 ADF REAR COVER .....	3-18
3.5.8 ADF MOTOR .....	3-19
3.5.9 ADF TOP COVER .....	3-20
3.5.10 DOCUMENT SENSOR .....	3-21
3.5.11 ADF FEED SENSOR .....	3-23
3.6 LASER UNIT .....	3-24
3.6.1 CAUTION DECAL LOCATIONS .....	3-24
3.6.2 LASER OPTICS HOUSING UNIT .....	3-25
Printer Models .....	3-25
MF Models .....	3-26
After replacing the laser optics housing unit .....	3-28
Printing out the test chart to make sure MUSIC was performed correctly .....	3-29
Checking that MUSIC was Performed Correctly .....	3-30
If MUSIC has not been performed successfully .....	3-31

3.7 AIO CARTRIDGE (ALL IN ONE CARTRIDGE).....	3-32
3.7.1 AIO CARTRIDGE.....	3-32
3.7.2 BLACK AIO MOTOR.....	3-32
3.7.3 COLOR AIO MOTOR.....	3-35
3.8 IMAGE TRANSFER .....	3-37
3.8.1 IMAGE TRANSFER BELT UNIT.....	3-37
After replacing the image transfer belt unit.....	3-38
3.8.2 ITB (IMAGE TRANSFER BELT) CLEANING UNIT .....	3-38
3.8.3 AGITATOR MOTOR .....	3-39
3.8.4 ITB (IMAGE TRANSFER BELT) CONTACT MOTOR.....	3-40
3.8.5 ITB (IMAGE TRANSFER BELT) CONTACT SENSOR.....	3-42
3.8.6 TM (TONER MARK) SENSOR BASE.....	3-43
3.8.7 WASTE TONER BOTTLE SET SENSOR.....	3-44
3.8.8 WASTE TONER OVERFLOW SENSOR.....	3-45
3.9 PAPER TRANSFER .....	3-46
3.9.1 TRANSFER UNIT .....	3-46
3.9.2 TRANSFER ROLLER .....	3-47
3.9.3 REGISTRATION ROLLER.....	3-48
Reassembling the registration roller unit.....	3-49
3.9.4 REGISTRATION SENSOR.....	3-49
3.9.5 REGISTRATION CLUTCH .....	3-50
3.10 IMAGE FUSING .....	3-51
3.10.1 FUSING UNIT .....	3-51
3.10.2 FUSING LAMP.....	3-53
When Reinstalling the Fusing Lamp.....	3-55
When Reassembling the Fusing Unit.....	3-56
3.10.3 TRANSPORT/FUSING MOTOR .....	3-56
3.11 PAPER FEED .....	3-58
3.11.1 PAPER FEED CLUTCH.....	3-58
3.11.2 PAPER FEED ROLLER .....	3-58
3.11.3 SEPARATION PAD.....	3-59
3.11.4 PAPER END SENSOR .....	3-60
3.12 PAPER EXIT .....	3-61
3.12.1 PAPER EXIT ROLLER.....	3-61
3.12.2 PAPER EXIT SENSOR.....	3-62
3.13 ELECTRICAL COMPONENTS .....	3-63
3.13.1 CONTROLLER BOARD.....	3-63
Controller Board (Printer Models).....	3-63
Controller Board (MF Models).....	3-64

3.13.2	EGB (ENGINE BOARD)	3-66
	EGB (Printer Models)	3-66
	EGB (MF Models)	3-67
3.13.3	FCU (ONLY FOR MF MODELS)	3-69
3.13.4	OPERATION PANEL	3-69
	Printer Models	3-70
	MF Models	3-70
	Printer Models	3-71
	MF Models	3-71
3.13.5	OPU	3-71
	OPU (Printer Models)	3-71
	OPU (MF Models)	3-72
3.13.6	WI-FI BOARD	3-73
3.13.7	INTERLOCK SWITCHES	3-74
3.13.8	FUSING FAN MOTOR	3-75
3.13.9	FUSING STRIPPER PAWL SOLENOID	3-76
3.13.10	FUSING PRESSURE RELEASE SENSOR	3-77
3.13.11	LSU FAN MOTOR	3-78
3.13.12	ID CHIP BOARD	3-78
3.13.13	PSU	3-79
3.13.14	HIGH VOLTAGE POWER SUPPLY BOARD	3-81
3.13.15	TEMPERATURE/HUMIDITY SENSOR	3-81
3.13.16	DUPLEX MOTOR	3-82
3.13.17	SPEAKER (ONLY FOR MF MODELS)	3-84
3.13.18	EEPROM	3-85
	Checking that MUSIC was Performed Correctly	3-87

#### **4. SYSTEM MAINTENANCE REFERENCE ..... 4-1**

4.1	SERVICE MENU	4-1
4.1.1	OVERVIEW	4-1
	Menu Mode	4-1
	Special Mode	4-1
4.1.2	MAINTENANCE MODE MENU (MF MODELS)	4-2
	Menu List	4-2
4.1.3	SERVICE MODE (PRINTER MODELS)	4-14
	Menu List	4-14
4.1.4	FAX SERVICE TEST MENU (ONLY FOR MF MODELS)	4-18
	Entering the Fax Service Test Menu	4-18
	Selecting an Item	4-18
	Going into the Next Level/ Returning to the Previous Level	4-18



Exiting the Maintenance Mode Menu .....	4-18
Menu List.....	4-18
4.1.5 SIZE MISMATCH DETECTION MENU.....	4-20
Entering the Size Mismatch Detection Menu.....	4-20
4.2 CONFIGURATION, MAINTENANCE AND TEST PAGE INFORMATION	4-21
4.2.1 OVERVIEW .....	4-21
To Print the Configuration Page/ Test Page/ Maintenance Page (Printer Models) .....	4-21
To Print the Configuration Page/ Maintenance Page (MF Models) ....	4-21
4.2.2 ERROR LOG .....	4-22
4.2.3 COUNTER AND COVERAGE (ONLY FOR PRINTER MODELS)..	4-23
Configuration Page.....	4-23
4.3 FIRMWARE UPDATING.....	4-24
4.3.1 CHECKING THE MACHINE FIRMWARE VERSION.....	4-24
To Print the Configuration Page (Printer Models).....	4-24
To Print the Configuration Page (MF Models) .....	4-24
4.3.2 UPDATING THE CONTROLLER FIRMWARE .....	4-25
Procedure.....	4-25
4.3.3 UPDATING THE ENGINE FIRMWARE.....	4-28
4.3.4 BOOT LOADER FIRMWARE .....	4-30
<b>5. TROUBLESHOOTING.....</b>	<b>5-1</b>
5.1 SERVICE CALL CONDITIONS.....	5-1
5.1.1 SUMMARY .....	5-1
5.1.2 ENGINE SC .....	5-1
SC 1xx (Other Error) .....	5-1
SC 2xx (Laser Optics Error) .....	5-2
SC 3xx (Charge Error).....	5-3
SC 4xx (Image Transfer and Transfer Error).....	5-4
SC 5xx (Motor and Fusing Error).....	5-5
SC 6xx (Communication and Other Error).....	5-10
5.1.3 CONTROLLER SC .....	5-11
SC8xx.....	5-11
5.2 ERROR CODES .....	5-12
5.2.1 OVERVIEW .....	5-12
5.2.2 ERROR CODES LIST.....	5-12
5.3 FAX ERROR CODE DEFINITION (ONLY FOR MF MODELS).....	5-16
5.3.1 BASIC ERROR CODE STRUCTURE.....	5-16
Digit 5 (far left): TX or RX.....	5-16
Digit 4: Coding (MH/MR/MMR/JBIG).....	5-16

Digit 3: Modem mode .....	5-17
Digit 2: Modem speed .....	5-18
5.3.2 ERROR CODE TABLE .....	5-19
The following information is also included in the User Guide. ....	5-21
5.4 FAX ERROR CLEAR PRINCIPLE (ONLY FOR MF MODELS) .....	5-25
5.4.1 RX.....	5-25
5.4.2 TX.....	5-25
5.5 IMAGE PROBLEMS .....	5-26
5.5.1 OVERVIEW .....	5-26
5.5.2 IMAGE PROBLEM.....	5-27
<b>6. ENVIRONMENTAL CONSERVATION .....</b>	<b>6-1</b>
6.1 ENERGY SAVING .....	6-1
6.1.1 ENERGY SAVER MODES .....	6-1
Timer Settings (Printer Models).....	6-2
Timer Settings (MF Models).....	6-2
Return to Stand-by Mode .....	6-2
Recommendation .....	6-3
6.2 PAPER SAVE .....	6-4
6.2.1 EFFECTIVENESS OF DUPLEX/COMBINE FUNCTION.....	6-4
1. Duplex.....	6-4
2. Combine mode .....	6-4
3. Duplex + Combine.....	6-5

# READ THIS FIRST

## Safety Notices

### Important Safety Notices

#### Prevention of Physical Injury

1. Before disassembling or assembling parts of the machine and peripherals, make sure that the machine power cord is unplugged.
2. The wall outlet should be near the machine and easily accessible.
3. If any adjustment or operation check has to be made with exterior covers off or open while the main switch is turned on, keep hands away from electrified or mechanically driven components.
4. The machine drives some of its components when it completes the warm-up period. Be careful to keep hands away from the mechanical and electrical components as the machine starts operation.
5. The inside and the metal parts of the fusing unit become extremely hot while the machine is operating. Be careful to avoid touching those components with your bare hands.

#### Health Safety Conditions

Toner is non-toxic, but if you get either of them in your eyes by accident, it may cause temporary eye discomfort. Try to remove with eye drops or flush with water as first aid. If unsuccessful, get medical attention.

#### Observance of Electrical Safety Standards

The machine and its peripherals must be serviced by a customer service representative who has completed the training course on those models.

## Safety and Ecological Notes for Disposal

1. Do not incinerate toner bottles or used toner. Toner dust may ignite suddenly when exposed to an open flame.
2. Dispose of used toner, the maintenance unit which includes developer or the organic photoconductor in accordance with local regulations. (These are non-toxic supplies.)
3. Dispose of replaced parts in accordance with local regulations.

### ⚠️ WARNING

- To prevent a fire or explosion, keep the machine away from flammable liquids, gases, and aerosols. A fire or an explosion might occur.

### ⚠️ CAUTION

- The Controller board on the MF model contains a lithium battery. The danger of explosion exists if a battery of this type is incorrectly replaced. Replace only with the same or an equivalent type recommended by the manufacturer. Discard batteries in accordance with the manufacturer's instructions and local regulations.

## Laser Safety

The Center for Devices and Radiological Health (CDRH) prohibits the repair of laser-based optical units in the field. The optical housing unit can only be repaired in a factory or at a location with the requisite equipment. The laser subsystem is replaceable in the field by a qualified Customer Engineer. The laser chassis is not repairable in the field. Customer engineers are therefore directed to return all chassis and laser subsystems to the factory or service depot when replacement of the optical subsystem is required.

### ⚠️ WARNING

- Use of controls, or adjustment, or performance of procedures other than those specified in this manual may result in hazardous radiation exposure.

#### WARNING:

Turn off the main switch before attempting any of the procedures in the Laser Optics Housing Unit section. Laser beams can seriously damage your eyes.

#### CAUTION MARKING:







3b\_decals



## Symbols, Abbreviations and Trademarks

This manual uses several symbols and abbreviations. The meaning of those symbols and abbreviations are as follows:

	Clip ring
	Screw
	Connector
	Clamp
	E-ring
SEF	Short Edge Feed
LEF	Long Edge Feed

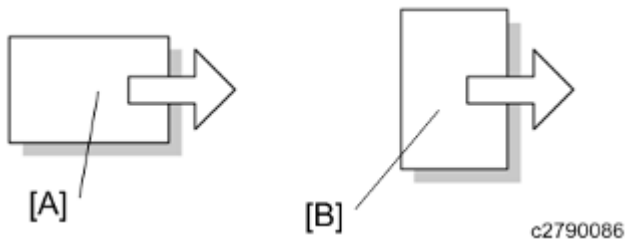

[A] Short Edge Feed (SEF)

[B] Long Edge Feed (LEF)

### Trademarks

Microsoft<sup>®</sup>, Windows<sup>®</sup>, Windows Server<sup>®</sup>, Windows Vista<sup>®</sup>, and Internet Explorer<sup>®</sup> are either registered trademarks or trademarks of Microsoft Corporation in the United States and/or other countries.

The proper name of Internet Explorer 6 is Microsoft<sup>®</sup> Internet Explorer<sup>®</sup> 6.

Adobe, Acrobat, PostScript, and Reader are either registered trademarks or trademarks of Adobe Systems Incorporated in the United States and/or other countries.

PCL<sup>®</sup> is a registered trademark of Hewlett-Packard Company.

Other product names used herein are for identification purposes only and might be trademarks of their respective companies. We disclaim any and all rights to those marks.

# PRODUCT INFORMATION

REVISION HISTORY		
Page	Date	Added/Updated/New
		None

# 1. PRODUCT INFORMATION

## 1.1 MACHINE OVERVIEW

### 1.1.1 COMPONENT LAYOUT

#### *Engine (M199/M200)*

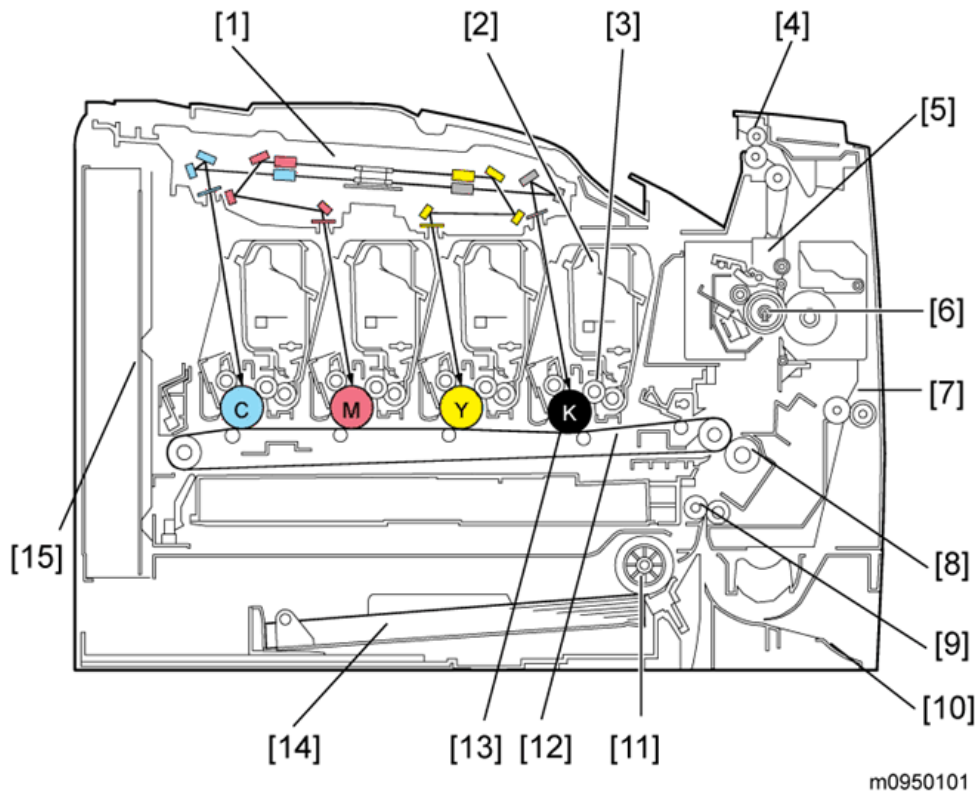

1. Laser Optics Housing Unit
2. Print Cartridge (AIO)
3. Development Roller (AIO)
4. Paper Exit
5. Fusing Unit
6. Fusing Lamp
7. Duplex Path
8. Transfer Roller

9. Registration Roller
10. By-pass
11. Paper Feed Roller
12. ITB (Image Transfer Belt) Unit
13. OPC (AIO)
14. Tray 1
- 15 EGB/Controller

**Engine (M203/M204)**

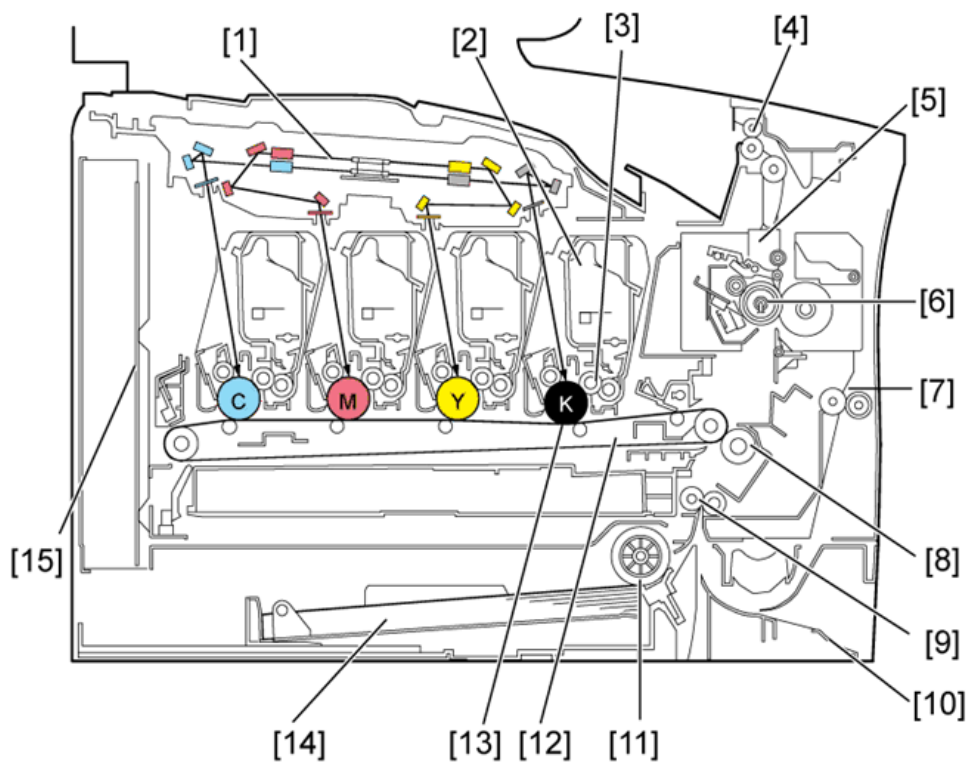

m0990101

1. Laser Optics Housing Unit	9. Registration Roller
2. Print Cartridge (AIO)	10. By-pass
3. Development Roller (AIO)	11. Paper Feed Roller
4. Paper Exit	12. ITB (Image Transfer Belt) Unit
5. Fusing Unit	13. OPC (AIO)
6. Fusing Lamp	14. Tray 1
7. Duplex Path	15. EGB/Controller
8. Transfer Roller	

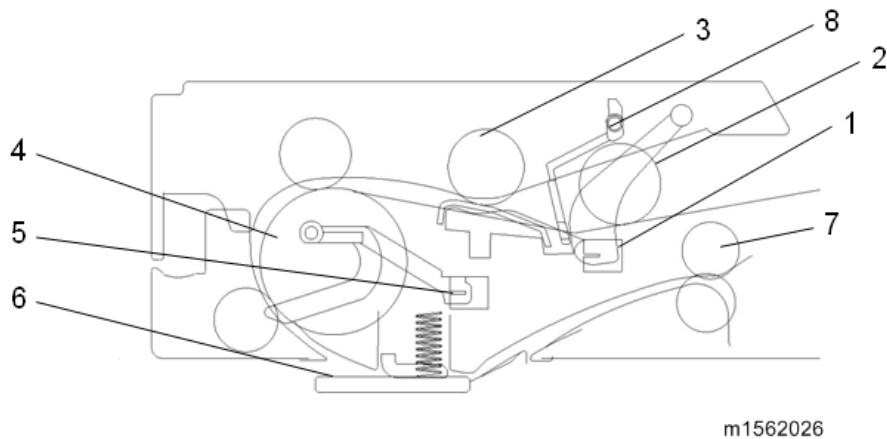

**ADF (only for M203/M204)**

- |                      |                      |
|----------------------|----------------------|
| 1. Document Sensor   | 5. Feed Sensor       |
| 2. Pick Roller       | 6. DF Exposure Glass |
| 3. Separation Roller | 7. Output Roller     |
| 4. Feed Roller       | 8. Media Stopper     |

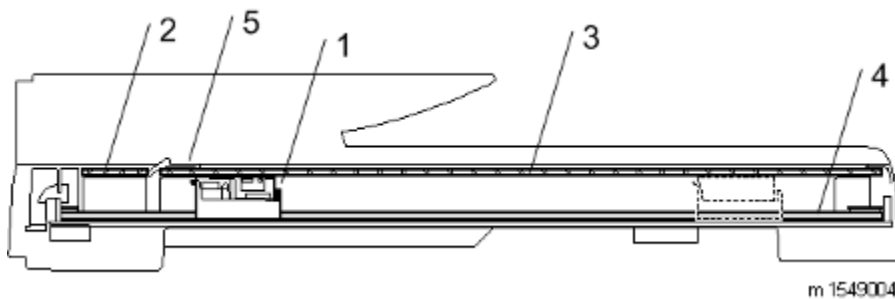
**Scanner (only for M203/M204)**

- |                           |                         |
|---------------------------|-------------------------|
| 1. CIS Carriage Unit      | 4. Carriage Drive Shaft |
| 2. DF Exposure Glass      | 5. White Sheet          |
| 3. Scanner Exposure Glass |                         |

### 1.1.2 PAPER PATH

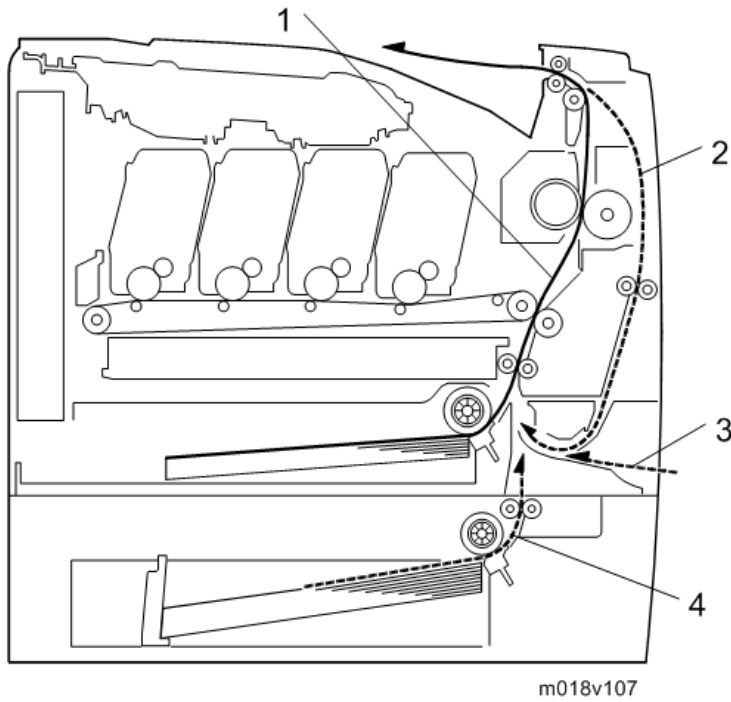

1. Paper path from tray 1
2. Duplex path
3. By-pass tray
4. Paper path from tray 2 (optional)

### ADF (only for M203/M204)

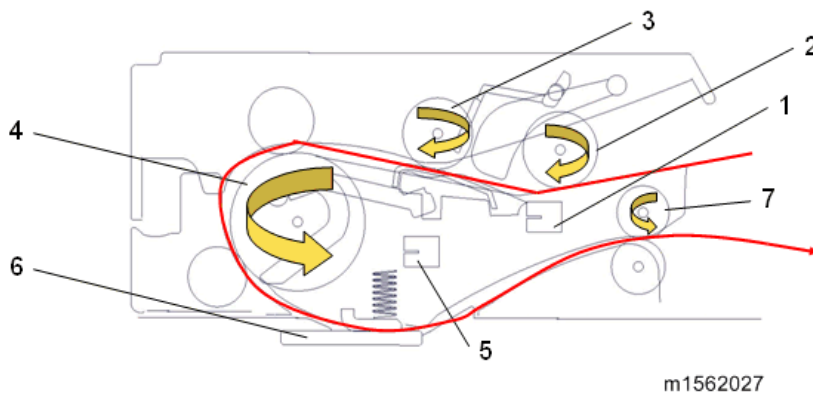

- |                      |                      |
|----------------------|----------------------|
| 1. Document sensor   | 5. Feed sensor       |
| 2. Pick roller       | 6. DF exposure glass |
| 3. Separation roller | 7. Output roller     |
| 4. Feed roller       |                      |

### 1.1.3 DRIVE LAYOUT

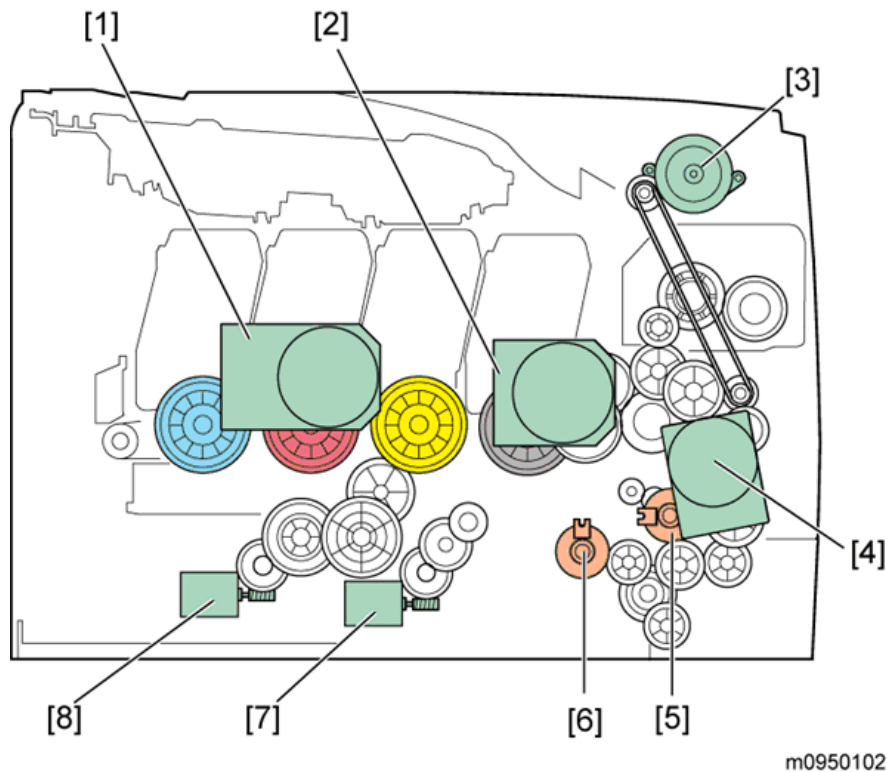

1. Color AIO Motor	5. Registration Clutch
2. Black AIO Motor	6. Paper Feed Clutch
3. Duplex Motor	7. Agitator Motor
4. Transport/Fusing Motor	8. ITB (Image Transfer Belt) Contact Motor

- **Color AIO Motor:**  
This drives the color AIOs (Cyan, Magenta and Yellow)
- **Black AIO Motor:**  
This drives the black AIO and the ITB (Image Transfer Belt).
- **Duplex Motor :**  
This drives the paper exit roller and the duplex roller.
- **Transport/Fusing Motor:**  
This drives the fusing unit, paper feed roller, registration roller and paper exit roller via the paper feed clutch, registration clutch and gears.
- **Registration Clutch:**  
This transfers drive from the transport/ fusing motor to the registration roller.
- **Paper Feed Clutch:**  
This transfers drive from the transport/ fusing motor to the paper feed roller.

## Machine Overview

- **Agitator Motor:**  
This moves the agitators in the waste toner bottle.
- **ITB Contact Motor:**  
This moves the ITB into contact with and away from the color OPCs.

## 1.2 MACHINE CONFIGURATION

### 1.2.1 PRINTER MODEL (M199/M200)

Duplex Unit	Optional Memory	Optional Tray (G849)	PCL/ PS
Auto	N	500 x 1	Y

### 1.2.2 MF MODEL (M203/M204)

Duplex Unit	Optional Memory	Optional Tray (G849)	PCL/ PS	Fax
Auto	N	500 x 1	Y	Y

## 1.3 GUIDANCE FOR THOSE WHO ARE FAMILIAR WITH PREDECESSOR PRODUCTS

The M199/M200 series models are similar to the M095/M096 series, and the M203/M204 series models are similar to the M099/M100 series. If you have experience with those products, the following information will be of help when you read this manual.

Different Points from Previous Products

### 1.3.1 PRINTER MODELS:

	New	Previous	
	M199/M200	M095	M096
PPM	20ppm	16ppm	20ppm
Wireless LAN	Standard	N/A	
PDL	PCL/PS	GDI	PCL/PS

### 1.3.2 MF MODELS:

	New	Previous	
	M203/M204	M099	M100
PPM	20ppm	16ppm	20ppm
Wireless LAN	Standard	N/A	
PDL	PCL/PS	GDI	PCL/PS
Scanner	CIS (3 channel)	CCD	
1st copy	20sec.	30sec.	

# **INSTALLATION**

## 2. INSTALLATION

### 2.1 INSTALLATION REQUIREMENTS

#### 2.1.1 ENVIRONMENT

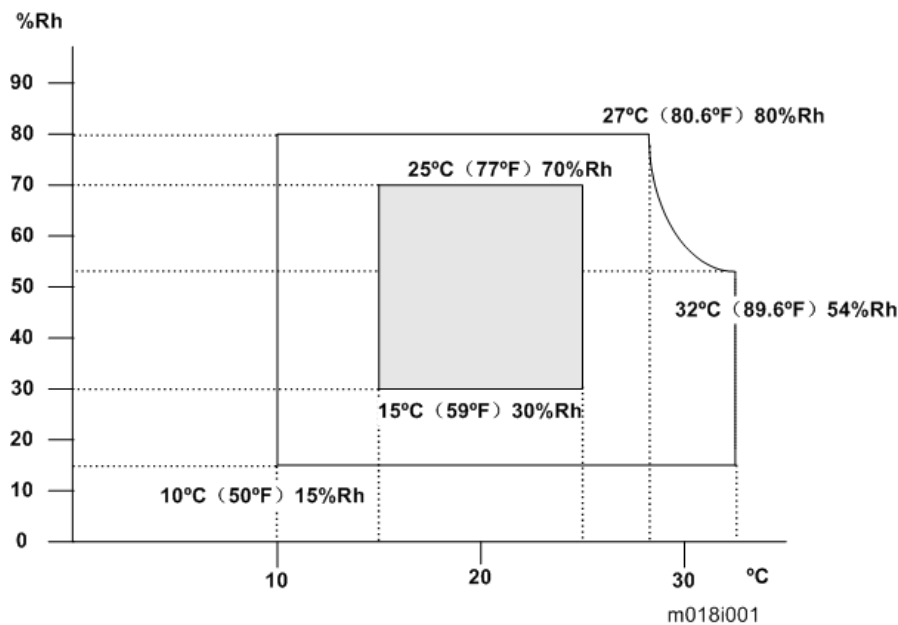

1. Temperature Range: 10°C to 32°C (50°F to 89.6°F)
2. Humidity Range: 15% to 80% RH
3. Ambient Illumination: Less than 2,000 lux (do not expose to direct sunlight)
4. Ventilation: 30 m<sup>3</sup>/hr/person
5. Do not put the machine in areas that get sudden temperature changes. This includes:
  - Areas directly exposed to cool air from an air conditioner
  - Areas directly exposed to heat from a heater.
6. Do not put the machine in areas that get exposed to corrosive gas.
7. Do not install the machine at locations over 2,500 m (8,202 ft.) above sea level.  
For Chinese model: 2,000 m (6,561 ft.)
8. Put the machine on a strong, level base. (Inclination on any side must be no more than 3 mm.)
9. Do not put the machine in areas with strong vibrations.

#### 2.1.2 MACHINE LEVEL

Front to back: Within 3 mm (0.12") of level

Right to left: Within 3 mm (0.12") of level



### 2.1.3 MACHINE SPACE REQUIREMENTS

Put the machine near the power source with these clearances:

#### ***Printer Models (M199/M200)***

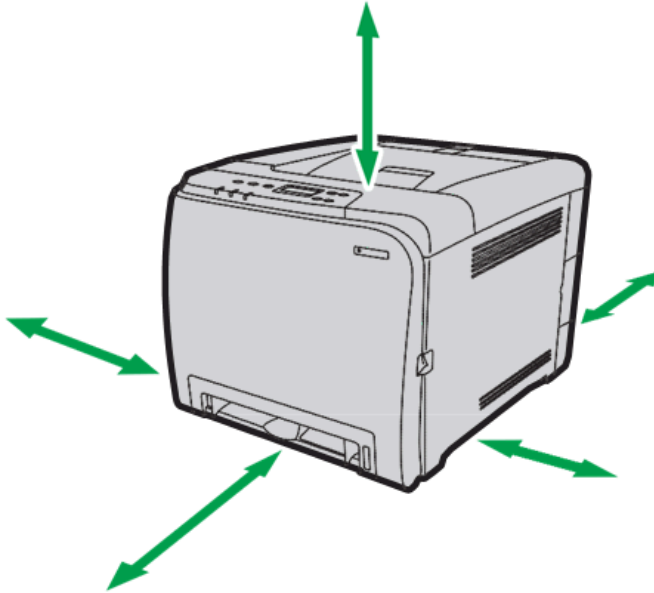

m199e2001

Left side: Over 20 cm (7.9")

Rear: Over 10 cm (4")

Right side: Over 10 cm (4")

Front: Over 70 cm (27.6")

Top: Over 33 cm (13")

**MF Models (M203/M204)**

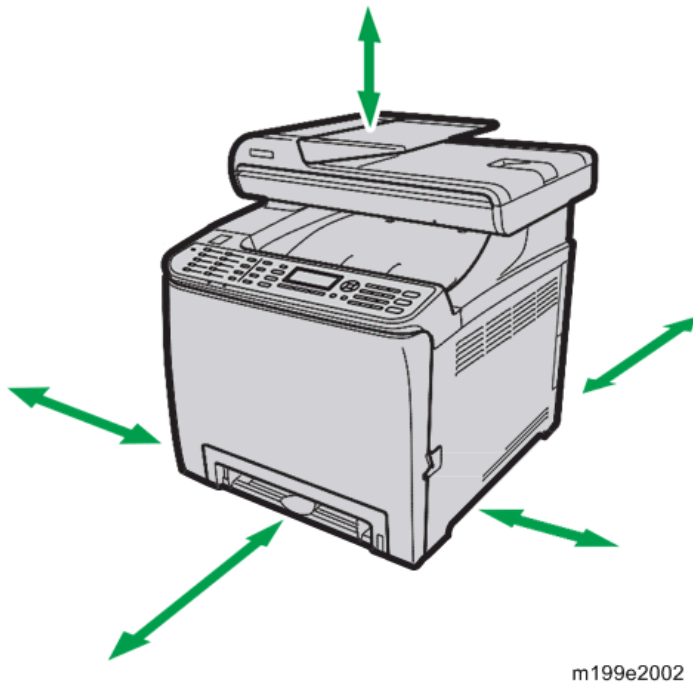

- Left side: Over 20 cm (7.9")
- Rear: Over 20 cm (7.9")
- Right side: Over 10 cm (4")
- Front: Over 70 cm (27.6")
- Top: Over 24 cm (9.5")

**2.1.4 POWER REQUIREMENTS**

**⚠ CAUTION**

- Make sure that the plug is tightly in the outlet.
- Avoid multi-wiring.
- Make sure that you ground the machine.

Input voltage level	120 V to 127 V, 60 Hz: Less than 11 A (for North America) 220 V to 240 V, 50 Hz/60 Hz: Less than 6 A (for Europe/ Asia) 110 V, 60 Hz: Less than 12 A (for Taiwan)
Permitted voltage fluctuation: 10%	
Do not set anything on the power cord.	

**2.1.5 INSTALLATION PROCEDURE**

Refer to the Quick Installation Guide for details about installing the machine.

# REPLACEMENT AND ADJUSTMENT

REVISION HISTORY		
Page	Date	Added/Updated/New
		None

---

## 3. REPLACEMENT AND ADJUSTMENT

### 3.1 BEFORE YOU START

#### 3.1.1 GENERAL PRECAUTIONS

##### CAUTION

- If there are printer jobs in the machine, print out all jobs in the printer buffer.
- Turn off the main power switch and unplug the machine before you do the procedures in this section.

Use extreme caution when removing and replacing components. The cables in the machine are located very close to moving parts; proper routing is a must.

After components have been removed, any cables that have been displaced during the procedure must be restored as close as possible to their original positions. Before removing any component from the machine, note any cable routings that may be affected.

##### **Before servicing the machine:**

1. Verify that documents are not stored in memory.
2. Remove the print cartridge before you remove parts.
3. Unplug the power cord.
4. Work on a flat and clean surface.
5. Replace with authorized components only.
6. Do not force plastic material components.

Make sure all components are returned to their original positions.

##### **AIO**

The AIO consists of the OPC drum, charge roller, development unit, cleaning components and toner tank. Observe the following precautions when handling the AIO.

1. Never touch the drum surface with bare hands. If the drum surface is dirty or if you have accidentally touched it, wipe it with a dry cloth, or clean it with wet cotton and then wipe it dry with a cloth.
2. Never use alcohol to clean the drum. Alcohol will dissolve the drum surface.
3. Store the AIO in a cool dry place.
4. Do not expose the drum to corrosive gases (ammonia, etc.).
5. Do not shake a used AIO, as this may cause toner to spill out.
6. Dispose of used AIO components in accordance with local regulations.

### ***Laser Unit***

1. Do not loosen or adjust the screws securing the LD drive board on the LD unit. Doing so will throw the LD unit out of adjustment.
2. Do not adjust the variable resistors on the LD unit, as these are permanently adjusted at the factory. If replacement of the LD drive board is necessary, replace the entire LD unit.
3. Keep the polygon mirror and toroidal lens free of dust. Laser performance is very sensitive to dust on these components.
4. Do not touch the shield glass or the surface of the polygon mirror with bare hands.
5. Do not adjust the Laser Synchronization detector on the LD unit, as these are permanently adjusted at the factory.

### ***Transfer Roller***

1. Never touch the surface of the transfer roller with bare hands.
2. Be careful not to scratch the transfer roller, as the surface is easily damaged.

### ***Fusing***

1. After installing the fusing thermistor, make sure that it is in contact with the hot roller and that the roller can rotate freely.
2. Be careful to avoid damage to the hot roller stripper pawls and their tension springs.
3. Do not touch the fusing lamp and rollers with bare hands.
4. Make sure that the fusing lamp is positioned correctly and that it does not touch the inner surface of the hot roller.

### ***Paper Feed***

1. Do not touch the surface of paper feed rollers.
2. To avoid misfeeds, the side and end fences in each paper tray must be positioned correctly so as to align with loaded paper size.

### Scanner Unit (for M203/M204)

1. Clean the parts indicated by arrows with a soft damp cloth and then wipe the same parts with a dry cloth to remove any remaining moisture.

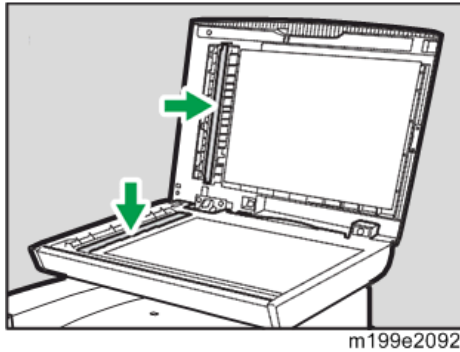

2. Do not disassemble the scanner unit.

### 3.1.2 RELEASING PLASTIC LATCHES

Many of the parts are held in place with plastic latches. The latches break easily, so release them carefully. To release a latch, press the hook end of the latch away from the part to which it is latched.

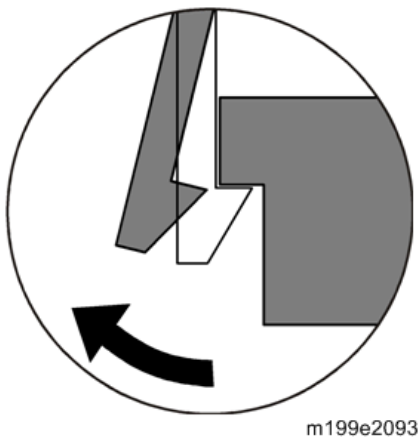

### 3.1.3 AFTER SERVICING THE MACHINE

1. Make sure all parts that require grounding are properly grounded.
2. Make sure the interlock switch is functioning.
3. Do not leave unused solder or parts inside the machine.
4. Do not leave any tools inside the machine.
5. Make sure all wires are properly connected and routed.
6. Make sure wires are not jammed between parts of the machine.

### 3.1.4 LITHIUM BATTERIES (MF MODELS)

#### CAUTION

- Incorrect replacement of lithium battery(s) on the controller or on the fax unit poses risk of explosion. Replace only with the same type or with an equivalent type recommended by the manufacturer. Discard used batteries in accordance with the manufacturer's instructions.

## 3.2 SPECIAL TOOLS

- PC: Windows XP/Vista/7/8 or Windows Server 2003/2003 R2/2008/2008 R2/2012.
- USB cable or Crossover cable



## 3.3 EXTERIOR COVERS

### ⚠ CAUTION

- Turn off the main power switch and unplug the printer before you do the procedures in this section.

### 3.3.1 REAR COVER

#### *Rear Cover (Printer Models)*

1. Rear tray cover [A]
2. Interface cover [B] (hook x 1)



m199e2003

3. Rear cover [C] (  x 3)



m199e2004

#### ↓ Note

- The screw in the Interface cover: M3 x 8, others: M4 x 10

### Rear Cover (MF Models)

1. Rear tray cover [A]



m199e2005

2. Rear cover [B] (  x 2)

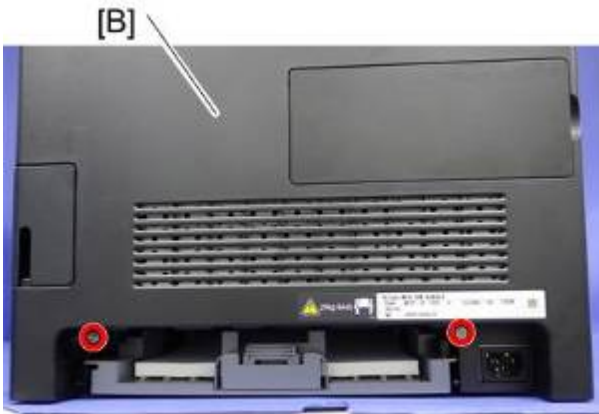

m199e2006

### 3.3.2 RIGHT COVER

1. Rear cover (page 3-6 "Rear Cover")
2. Operation panel (page 3-69 "Operation Panel")
3. Right cover [A] (  x 4)



 **Note**

- Top front screw: M3 x 8, others: M4 x 10

### 3.3.3 LEFT COVER

1. Open the top cover.

#### *Printer Models*

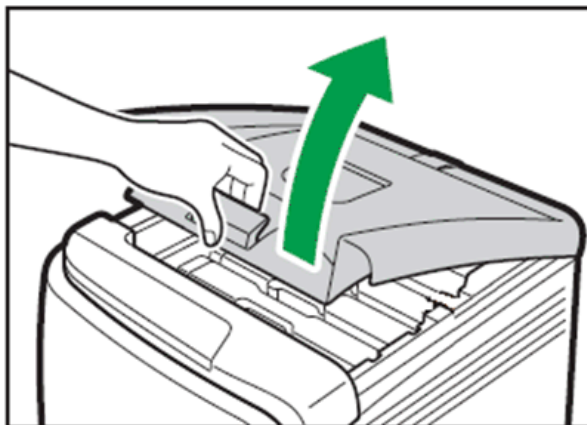

m199e2008

**MF Models**

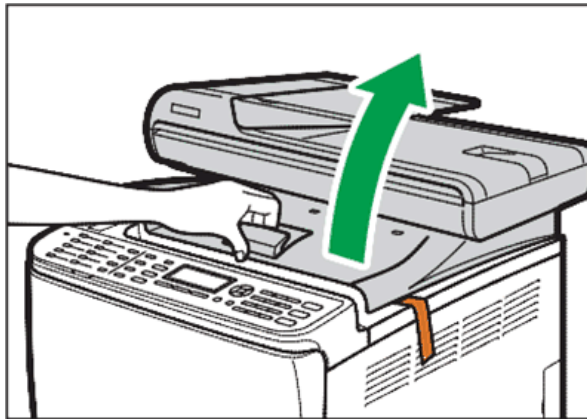

m199e2009

2. Open the front cover.

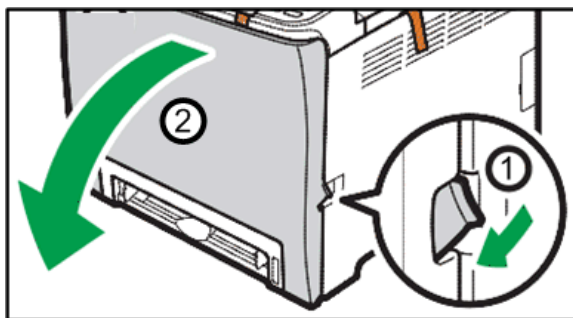

m199e2010

3. Left cover [A] (  x 3, hook at the arrow mark below)



m199e2011

**Note**

- Top front screw: M3 x 8, others: M4 x 10
- Remove the rear cover and the operation panel in advance when you meet difficulties in removing the left cover.

### 3.3.4 FRONT COVER UNIT

1. Rear cover (page 3-6 "Rear Cover")
2. Operation panel (page 3-69 "Operation Panel")
3. Transfer unit (page 3-46 "Transfer Unit")
4. Right cover (page 3-8 "Right Cover")
5. Cover link gear unit [A] (  × 2)

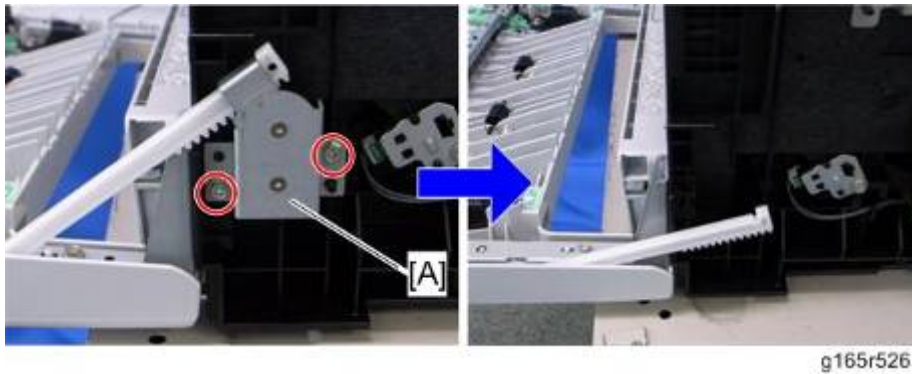

6. Release the belt [B]
7. Front cover unit [C] (  × 4)

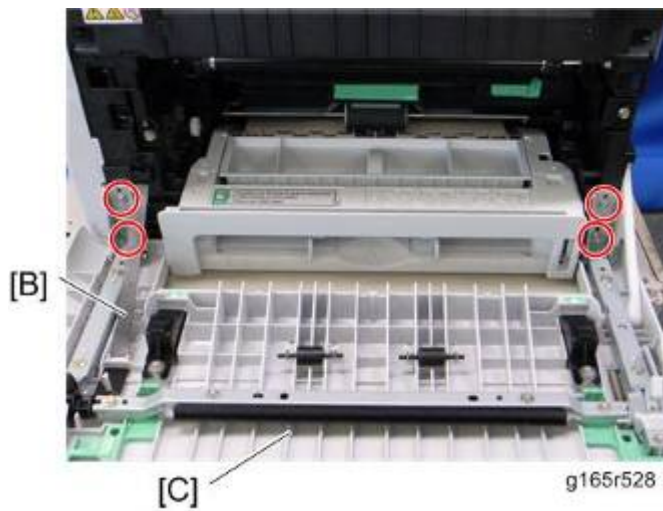

## 3.4 SCANNER UNIT (ONLY FOR MF MODELS)

### 3.4.1 SCANNER UNIT

1. Rear cover (page 3-6 "Rear Cover")
2. Controller box cover (page 3-63 "Controller Board")
3. Remove the left stand cover [A] and right stand cover [B]. (hook × 1 each)
4. Disconnect the two flat cables [C] with the ferrite core [D] (  ×2, 2 hooks).

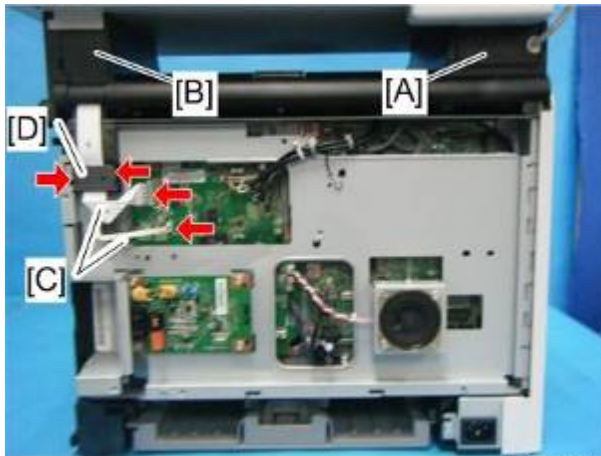

m199e2012

5. Disconnect the three harnesses and ground wire from the left stand. (  × 3,  × 1)

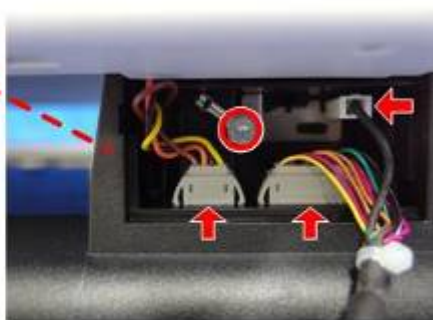

m199e2013

6. Open the top cover and remove the stepped screw [E].



m199e2015

## Scanner Unit (only for MF Models)

### ↓ Note

- Stepped screw is a plastic screw with an anchor.
- Pull it out grasping the anchor with pliers, etc after loosening it halfway.



m199e2014

7. Close the top cover.
8. Slide the scanner unit [F] in the direction of the blue arrow and pull it out while pushing the lock button [G].

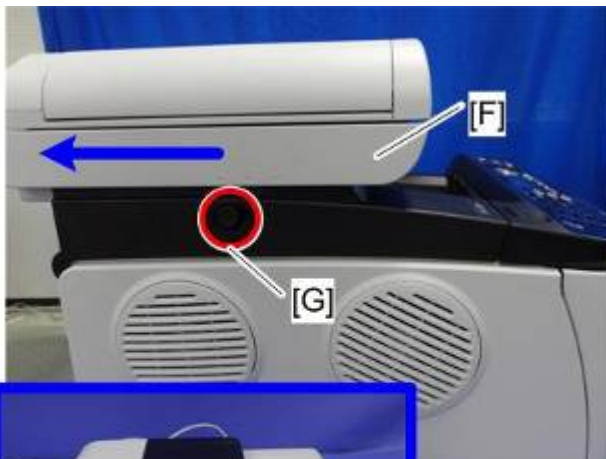

m199e2016

9. Open the ADF while pressing the ADF release bar [H] on the rear of the scanner unit.

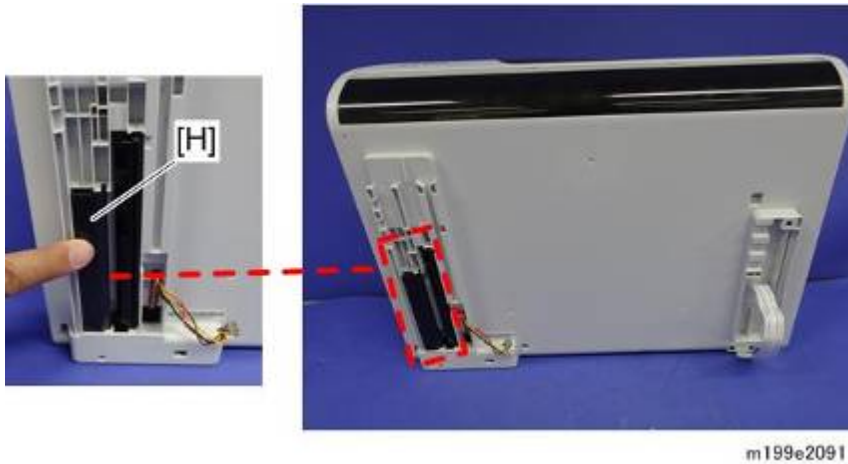

10. Remove the ADF unit [I] from the scanner unit in the direction of the blue arrow.  
(hooks)

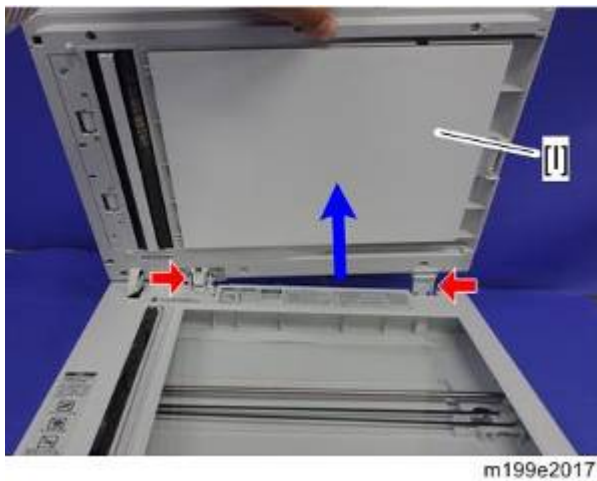



## 3.5 ADF (ONLY FOR MF MODELS)

### 3.5.1 ADF UNIT

1. Left stand cover [A]. (hook x 1)
2. Disconnect the 2 harnesses from the left stand. (  x 2)

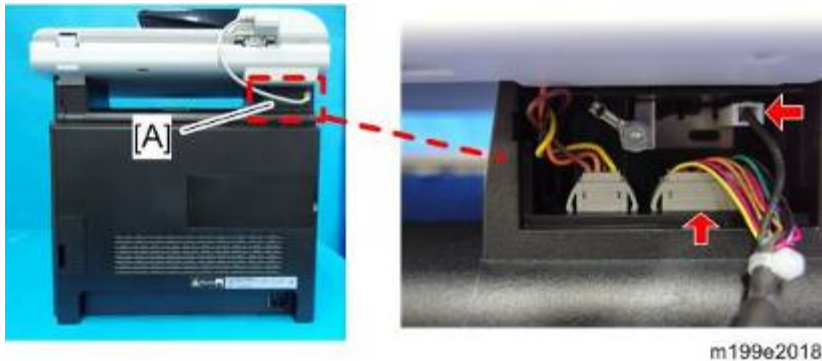

m199e2018

3. Open the ADF unit [B] and remove it in the direction of the blue arrow. (hooks)

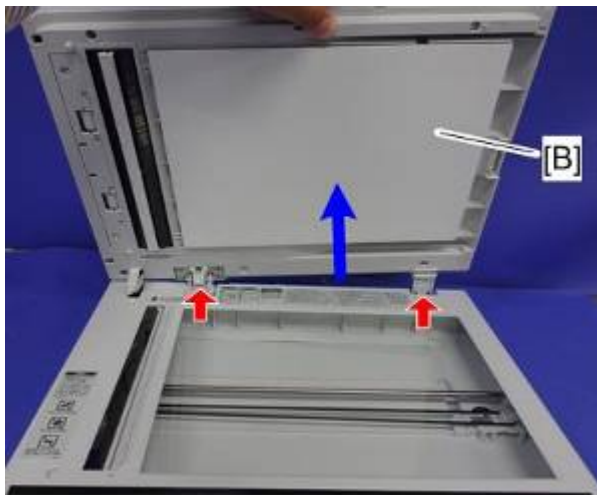

m199e2019

### 3.5.2 ORIGINAL TRAY

1. Open the extension tray [A] and then open the ADF top cover [B].

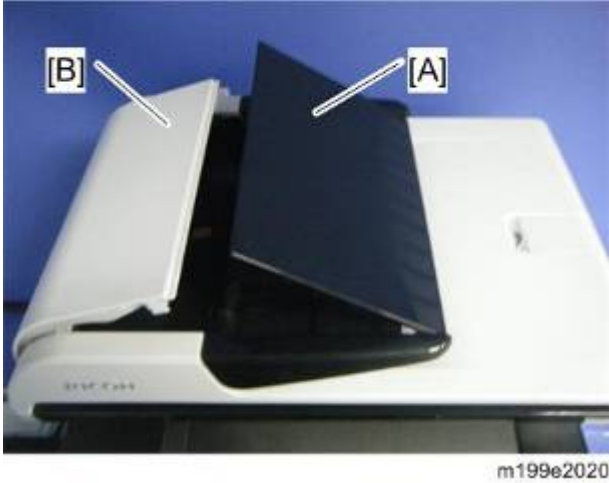

- 2. Original tray [C] (2 tabs)



**3.5.3 ADF PICK-UP ROLLER**

- 1. Open the ADF top cover [A].
- 2. ADF feed unit [B] (tab)

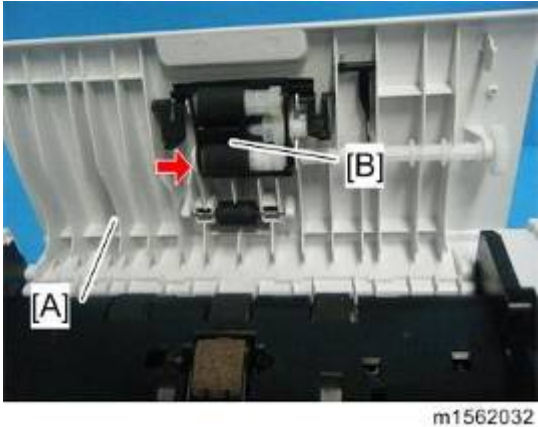

- 3. ADF pick-up roller [C]

**Note**

- Be careful not to lose the spring.

ADF (only for MF Models)

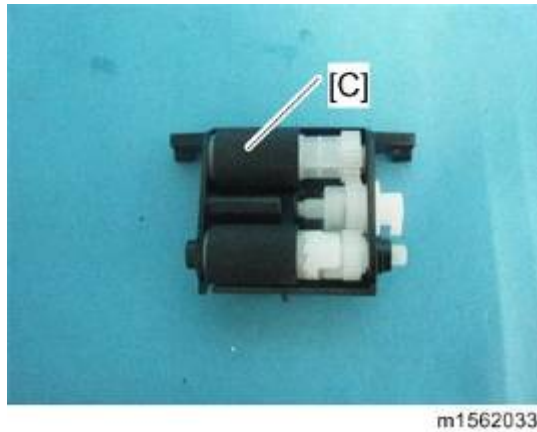

m1562033

### 3.5.4 ADF FEED ROLLER

1. ADF feed unit (page 3-15 "ADF Pick-Up Roller")
2. ADF feed roller [A]

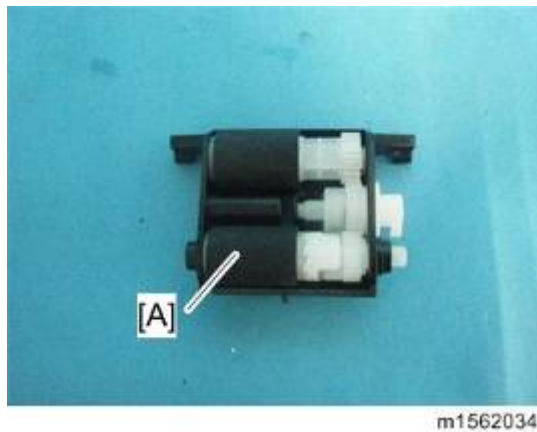

m1562034

### 3.5.5 ADF SEPARATION PAD

1. Open the ADF top cover.
2. ADF separation pad [A] (2 hooks, spring x 1)

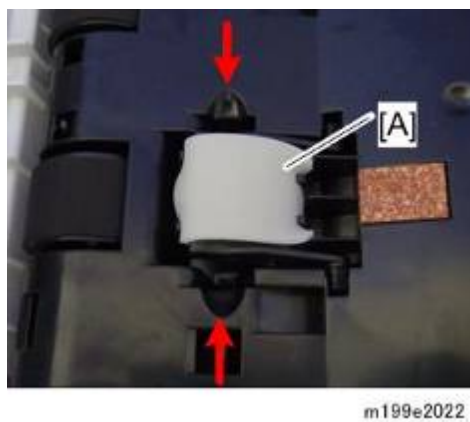

m199e2022

### 3.5.6 ADF FRONT COVER

1. ADF unit (page 3-14 "ADF Unit")
2. Original tray (page 3-14 "Original Tray")
3. Turn the ADF unit over.
4. ADF front cover [A] (  × 2, 2hooks)

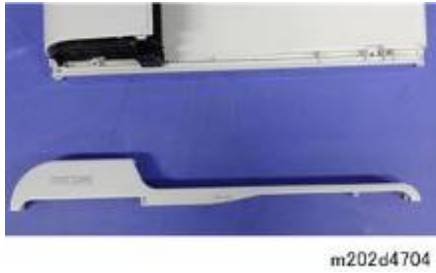

### 3.5.7 ADF REAR COVER

1. ADF unit (page 3-14 "ADF Unit")
2. Original tray (page 3-14 "Original Tray")
3. Turn the ADF unit over.
4. ADF rear cover [A] (  x 2, 2hooks)

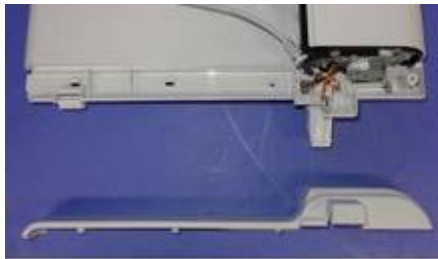
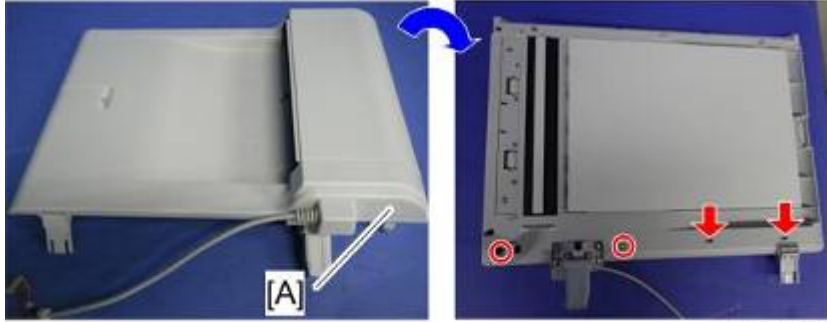

### 3.5.8 ADF MOTOR

- 1. ADF unit (page 3-14 "ADF Unit")
- 2. ADF front cover (page 3-17 "ADF Front Cover ")
- 3. ADF rear cover (page 3-18 "ADF Rear Cover")
- 4. Remove the ADF drive unit [A] while the ADF top cover [B] remains closed. (  x 2)

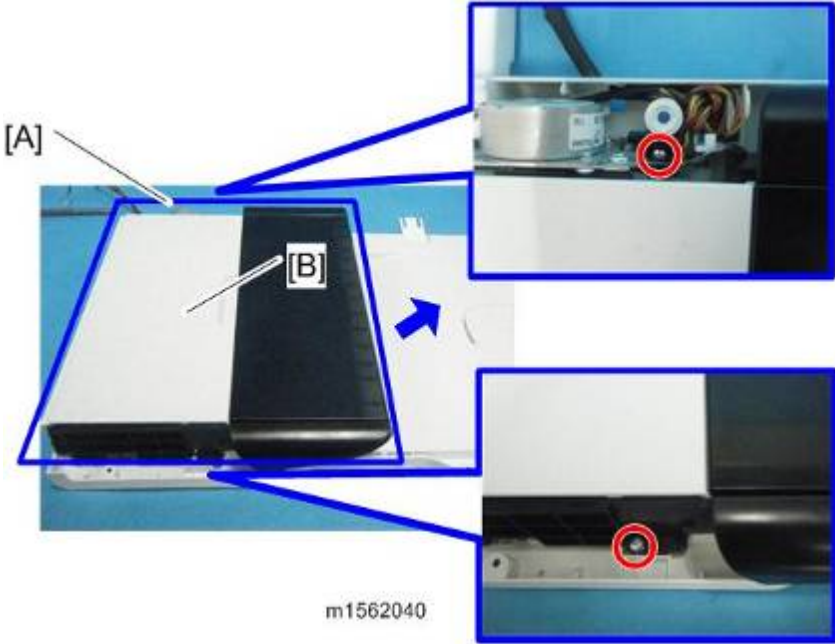

Replacement and Adjustment

- 5. ADF motor assembly [C] (  x 2, ground screw x 1,  x 1, ground plate, discharge brush)

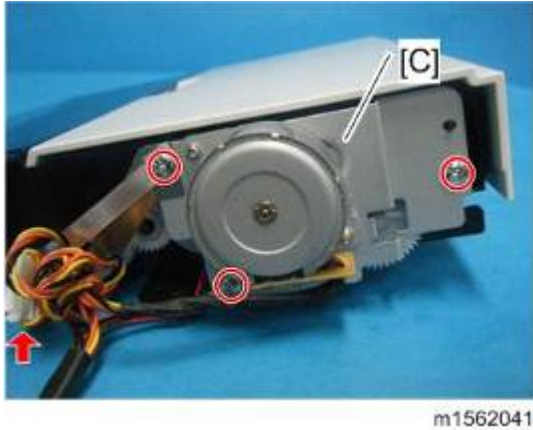

- 6. ADF motor [D] (  x 2)

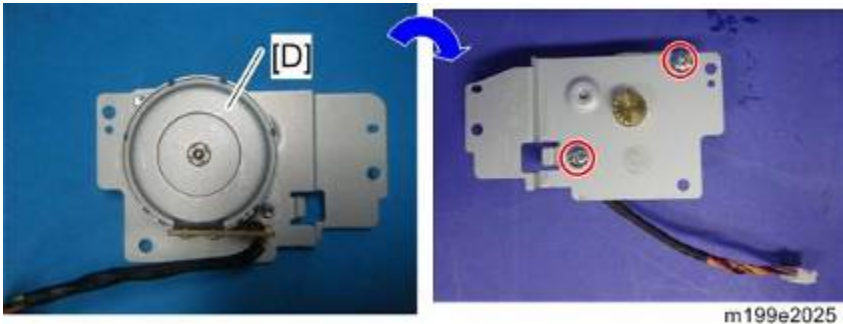

### 3.5.9 ADF TOP COVER

1. ADF drive unit (page 3-19 "ADF Motor")
2. Open the ADF top cover [A] and remove it. (two tabs)

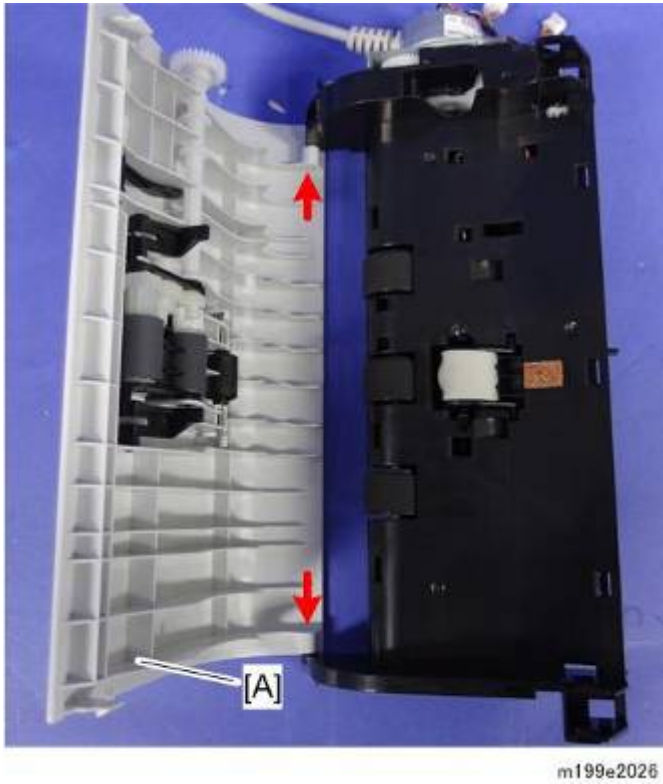

### 3.5.10 DOCUMENT SENSOR

1. ADF drive unit (page 3-19 "ADF Motor")
2. Turn the ADF drive unit over.
3. Pressure plate [A] (4 hooks, 2 springs)

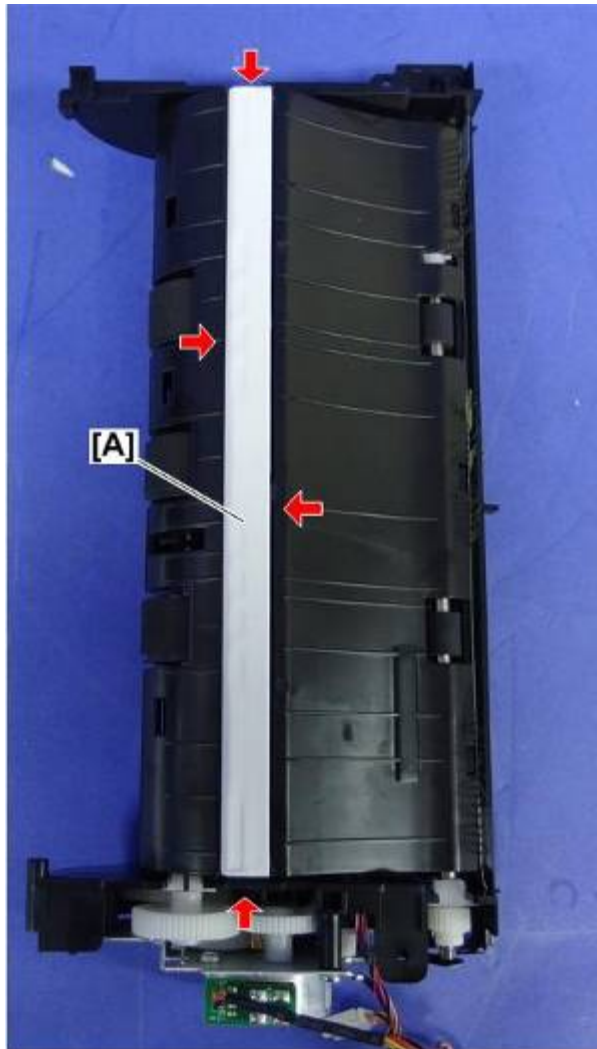

m202d4709

4. Lower guide [B] (  x 2, 6 hooks, 2 tabs)



ADF (only for MF Models)



m199e2027

5. Document sensor [C] (4 hooks,  x1)

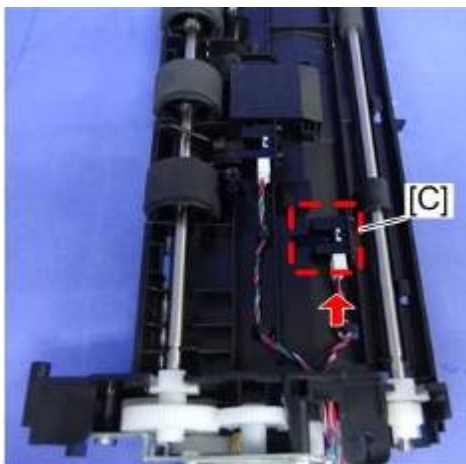

m199e2028

### 3.5.11 ADF FEED SENSOR

1. ADF drive unit (page 3-19 "ADF Motor")
2. Lower guide (page 3-21 "Document Sensor")
3. ADF feed sensor [A] (4 hooks,  x 1)

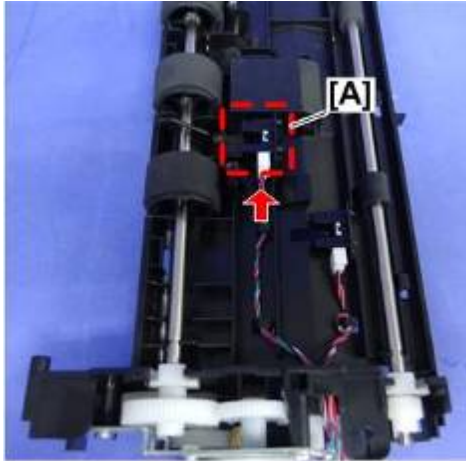

m202d4713

## 3.6 LASER UNIT

### **⚠ WARNING**

- Turn off the main power switch and unplug the printer before beginning any of the procedures in this section. Laser beams can cause serious eye injury.

### 3.6.1 CAUTION DECAL LOCATIONS

Caution decals are attached as shown below.

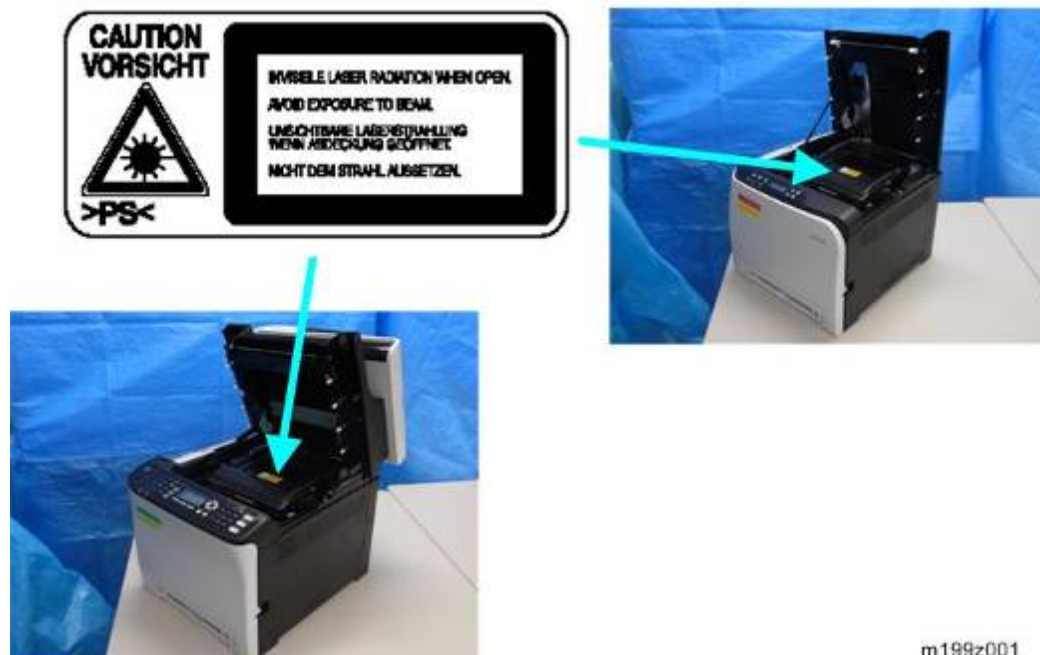

m199z001

### **⚠ WARNING**

- Be sure to turn off the main power switch and disconnect the power plug from the power outlet before beginning any disassembly or adjustment of the laser unit. This printer uses a class IIIb laser beam with a wavelength of 655 nm and an output of 7 mW. The laser can cause serious eye injury.

### 3.6.2 LASER OPTICS HOUSING UNIT

1. Rear cover (page 3-6 "Rear Cover")
2. Controller box cover (page 3-63 "Controller Board")
3. Only for MF Models: Interface bracket (page 3-63 "Controller Board")
4. Disconnect the three harnesses from CN301, 302 and 303 on the EGB. (  x 3)



m199e2029

5. Open the top cover.

#### *Printer Models*

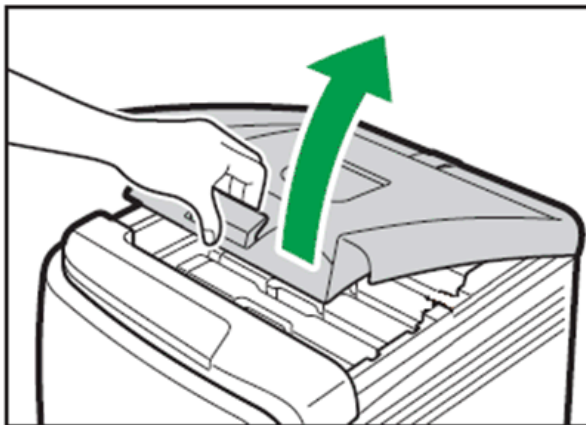

m199e2008

**MF Models**

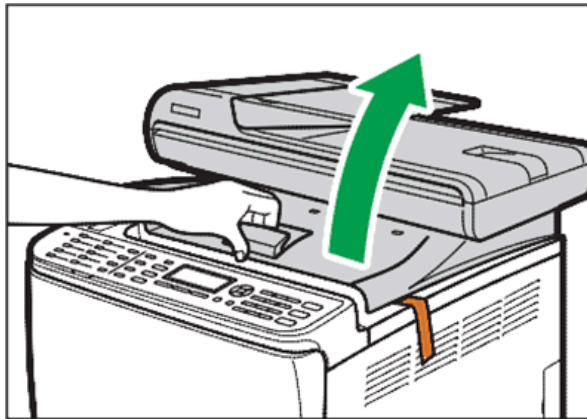

m199e2009

6. Remove the harness guide [A] on the rear-left frame.

Lift up the hook [B] of the harness guide and slide the harness guide to the right.



m199e2030

7. Stoppers [C] (  × 2 each: left side and right side)
8. Remove the springs [D] (left side and right side).

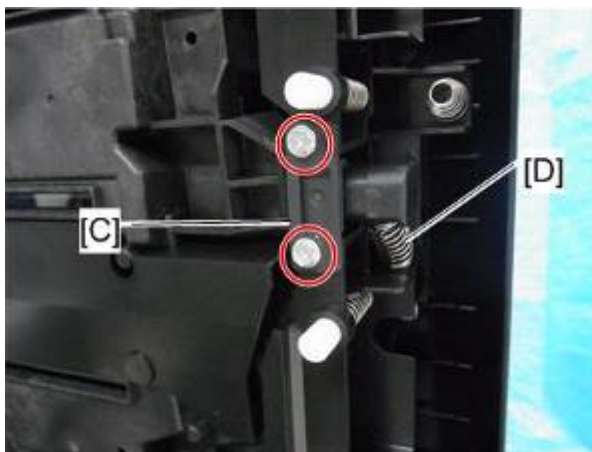

m199z009

9. Remove the laser optics housing unit [E] from the top cover and place it on the main body.

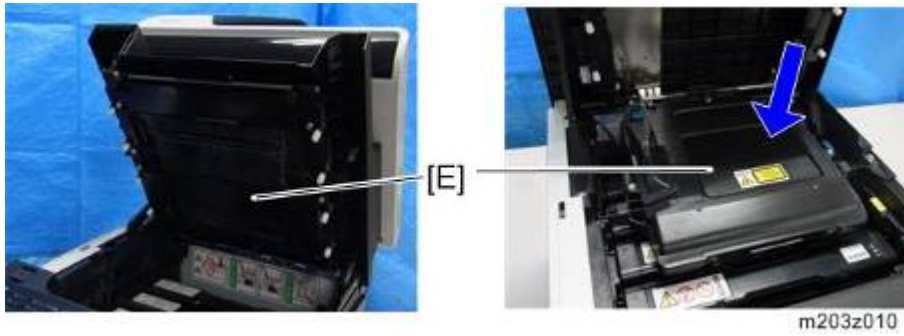

**Note**

- Always use two hands when carrying the laser optics housing unit. Be sure not to drop the laser optics housing unit.

**10. Take out the harnesses [F]. (  × 1 )**



**11. Laser optics housing unit [G].**



### ***After replacing the laser optics housing unit***

1. **Open the front cover and turn on the machine.**

**★ Important**

- **Do the following 2 steps with the front cover of the machine open.**
  1. **On the LCD, access “LSU Adjustment” inside the “Engine Maintenance” menu.**
  2. **Manually input the corresponding LSU data from your supervisor into the space provided on the LCD.**

2. **Close the front cover.**

3. **Perform “Color Registration” in the “Engine Maintenance” menu.**

4. **Turn the power off and on.**

**↓ Note**

- **MUSIC will be performed automatically.**

5. **Print out the test chart, and make sure that MUSIC was performed successfully (see ‘Printing out the Test Chart’ and ‘Checking that MUSIC was Performed Correctly’ below).**

6. **If necessary, adjust the registration settings for each tray and for the front and rear sides of the paper with the "Engine Maintenance" menu.**

**↓ Note**

- **When the MUSIC error persists, contact your supervisor, and get a set of LD parameters for the unit. After that, enter them with “LSU Adjustment” in the Maintenance Mode Menu (“If MUSIC has not been performed successfully” below).**

### Printing out the test chart to make sure MUSIC was performed correctly

1. Click the “Properties” tab inside the printer driver.
2. Click the “Print Quality” tab.
3. Select the “Manual” radio button.
4. Click [Advanced...].

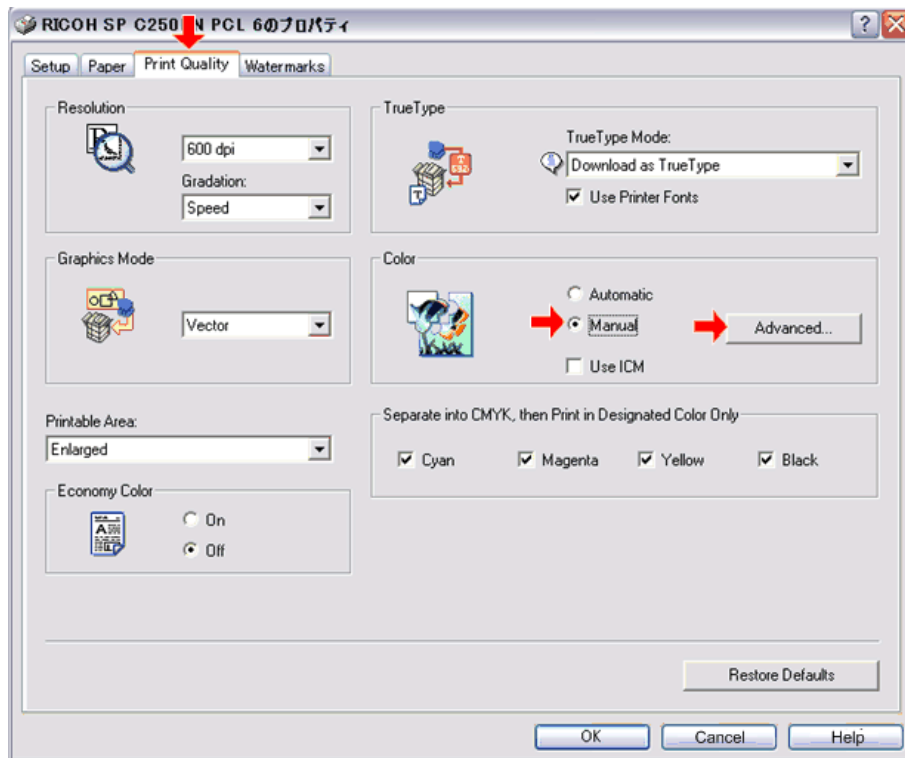

m199e2065

5. Select “Off” for the three Color Profile pull-down menus shown (i.e. for Text, Graphics, and Photo modes).
6. Click [OK] twice to print out the test chart.

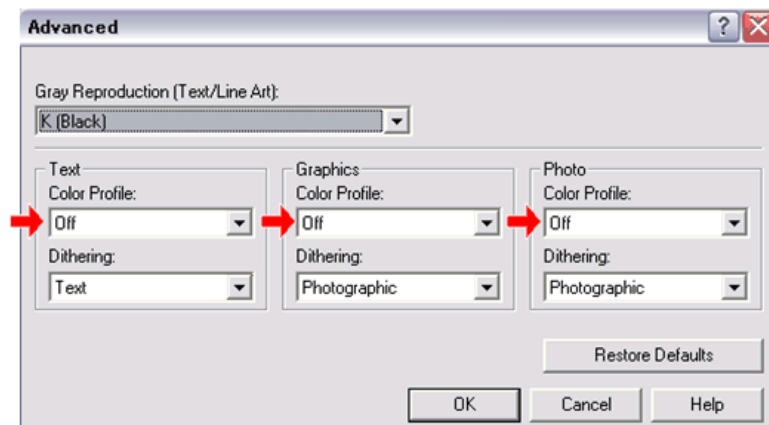

m199e2066

7. Make sure that MUSIC was performed successfully.



**Checking that MUSIC was Performed Correctly**

Four sets of vertical lines [A] appear on the test chart (C and k, M and k, Y and k...). In each set, look for vertical lines that are aligned within the region defined by "OK".

If all sets have at least one set of vertical lines that are aligned MUSIC was successful.

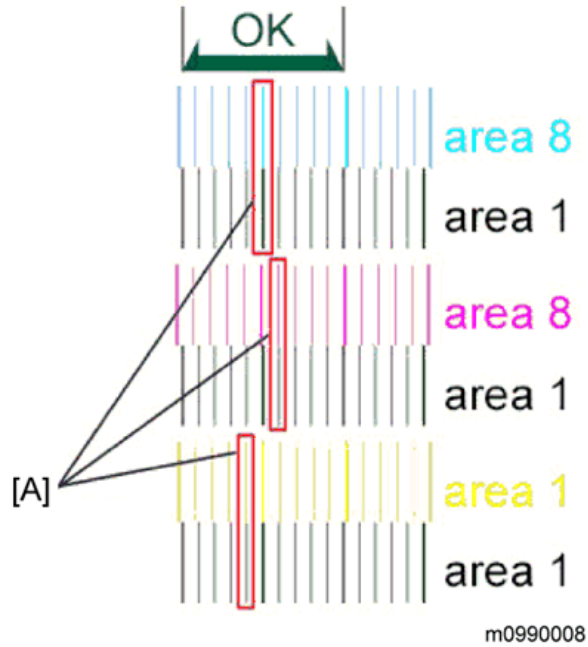

***If MUSIC has not been performed successfully***

1. Open the upper cover and check the lot number of the laser optics housing unit.
2. Contact your supervisor, and get the LD parameters for this lot number [A].

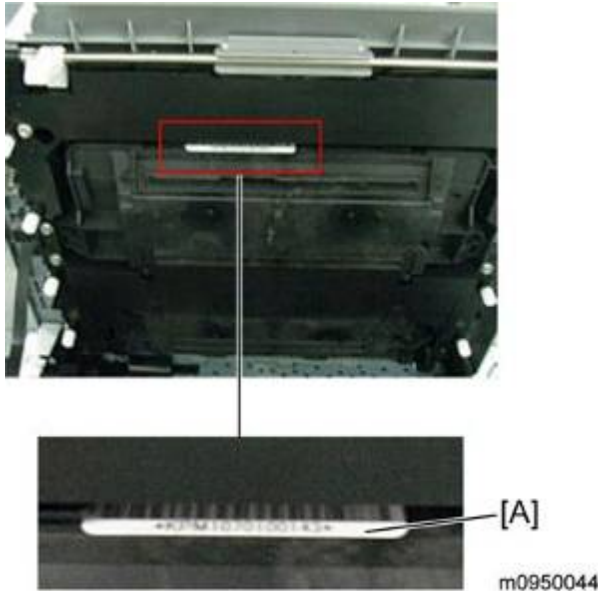

3. Open the front cover and turn on the machine.
4. Program the settings for the laser optics housing unit.
  - On the LCD, access “LSU Adjustment” inside the “Engine Maintenance” menu.
  - Manually input the corresponding LSU data from your supervisor into the space provided on the LCD.
5. Close the front cover.
6. Execute “Color Registration”, which is inside the “Engine Maintenance” menu.
7. Turn the main power Off and On.
 

ⓘ Note

  - MUSIC will be performed automatically.
8. If necessary, adjust the registration settings for each tray and for the front and rear sides of the paper with the "Engine Maintenance" menu.

## 3.7 AIO CARTRIDGE (ALL IN ONE CARTRIDGE)

### 3.7.1 AIO CARTRIDGE

1. Open the top cover.
2. AIO cartridge [A]



m199e2031

### 3.7.2 BLACK AIO MOTOR

1. Left cover (page 3-8 "Left Cover")
2. Disconnect the fusing connector [A] and remove the fusing relay harness [B] (2hooks).

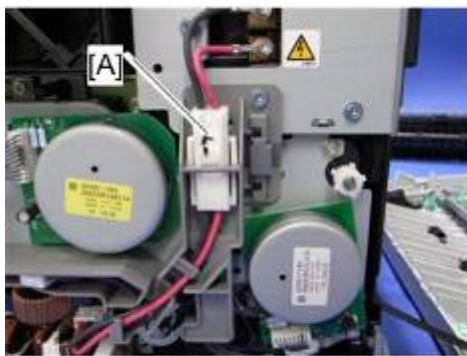

m018r531

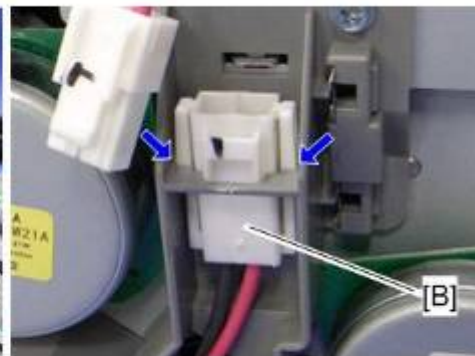



m018r532

3. Fusing harness guide [C] (  x 2 )



4. Fusing thermistor harness guide [D] (  x 2,  x 1 )



5. Disconnect the connectors shown by arrows in the picture below and release all harnesses on the harness guide [E]. (  x 4,  x 1 )

6. Harness guide [E] (  x4, hook x 1 )

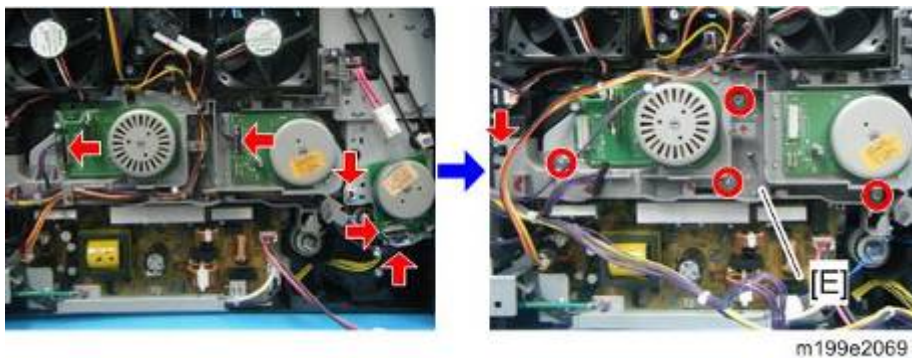

AIO Cartridge (All In One Cartridge)

7. Drive unit [F] (  × 4)



8. ITB gear [G], Color AIO motor [H] [I] (snap ring × 1 each)

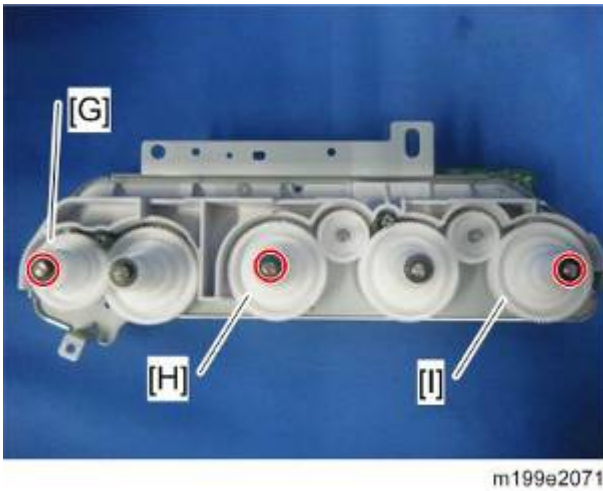

9. Drive unit guide [J] (  × 3)

10. Black AIO gear [K] (snap ring × 1)

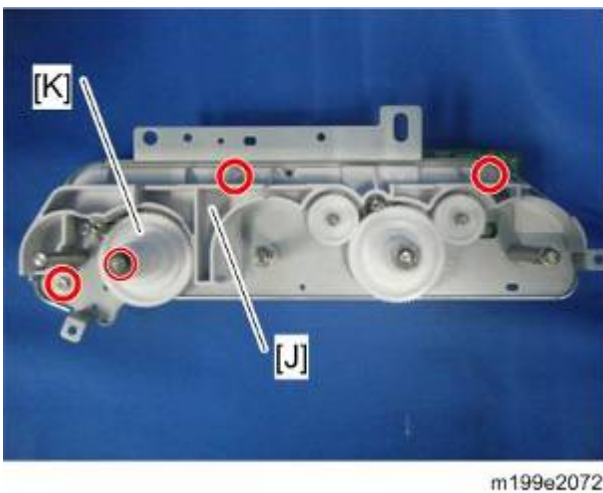

11. Black AIO motor [L] (  x 3)

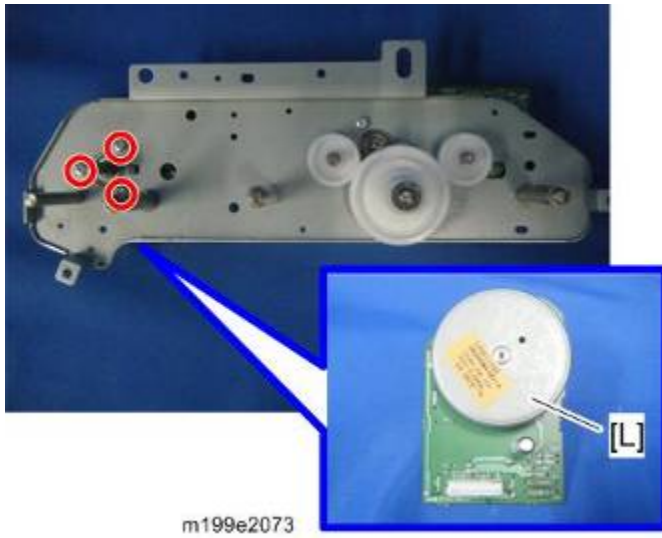

### 3.7.3 COLOR AIO MOTOR

1. Drive unit (page 3-32 "Black AIO Motor")
2. ITB gear [A], Color AIO motor [B] [C] (snap ring x 1 each)

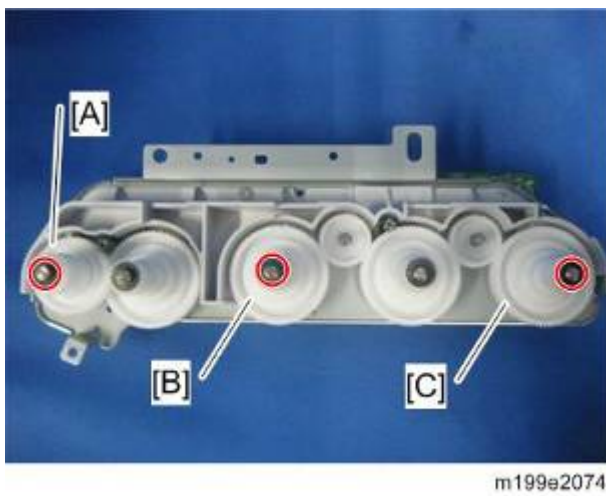

## AIO Cartridge (All In One Cartridge)

3. Drive unit guide [D] (  × 3)
4. Idler gear [E], AIO gear [F] (snap ring × 1)

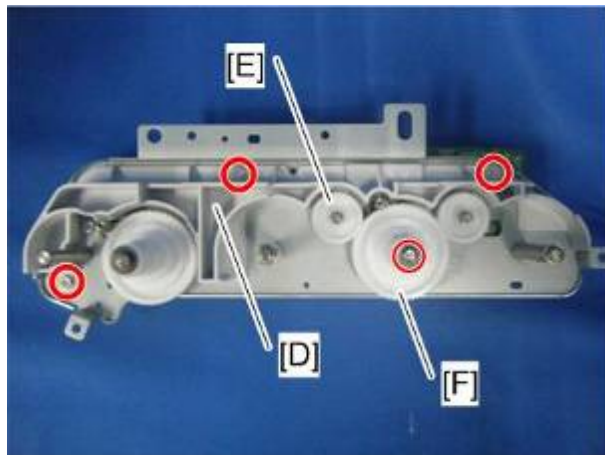

m199e2075

5. Color AIO motor [G] (  × 3)

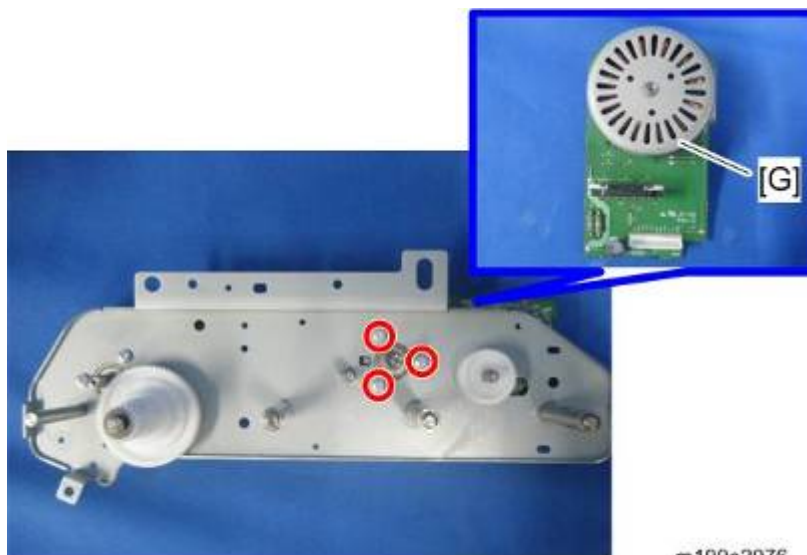

m199e2076

## 3.8 IMAGE TRANSFER

### 3.8.1 IMAGE TRANSFER BELT UNIT

1. Remove all the AIO cartridges (page 3-32 "AIO Cartridge").
2. Transfer unit (page 3-46 "Transfer Unit")
3. Pull out the waste toner bottle [A].

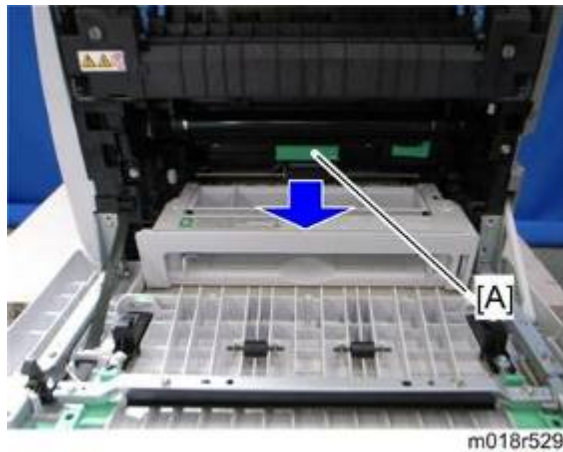

4. Release the hook [B] under the guide plate.
5. Move the guide plate [C] underneath the fusing unit to the left, and then remove it.

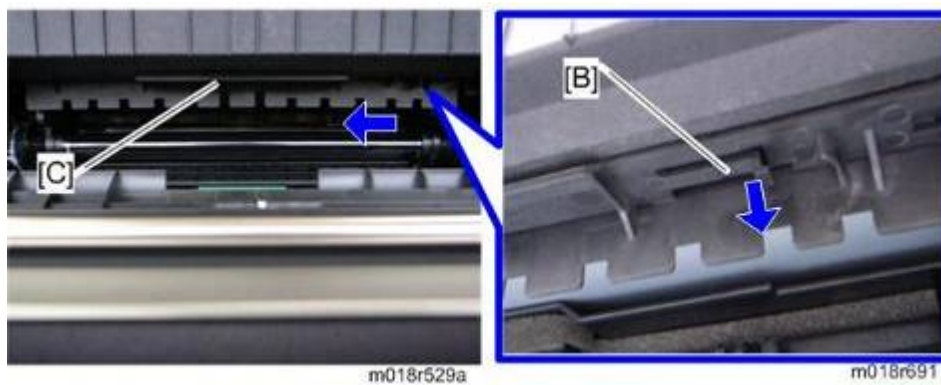

6. Pull out the image transfer belt unit [D]. (  × 2)

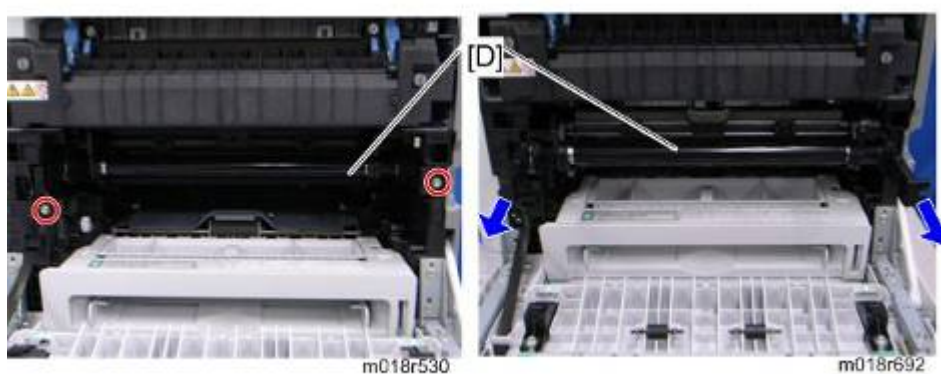



### After replacing the image transfer belt unit

#### ★ Important

- Do the following step 2 with the front cover of the machine open.
1. Open the front cover and turn on the machine.
  2. Execute "Reset Transfer Unit" with the "Engine Maintenance" menu.
  3. Close the front cover.
  4. Execute "Trans. Belt Adjust" with the "Engine Maintenance" menu.
  5. Adjust the registration settings for each tray and for the front and rear sides of the paper with the "Engine Maintenance" menu if necessary.

### 3.8.2 ITB (IMAGE TRANSFER BELT) CLEANING UNIT

#### ↓ Note

- The ITB cleaning unit contains waste toner. When removing the ITB cleaning unit, put it on a sheet of paper.
1. Image transfer belt unit (page 3-37 "Image Transfer Belt Unit")
  2. Left handle [A] (hook, bushing × 1)
  3. Right handle [B] (hook, bushing × 1)

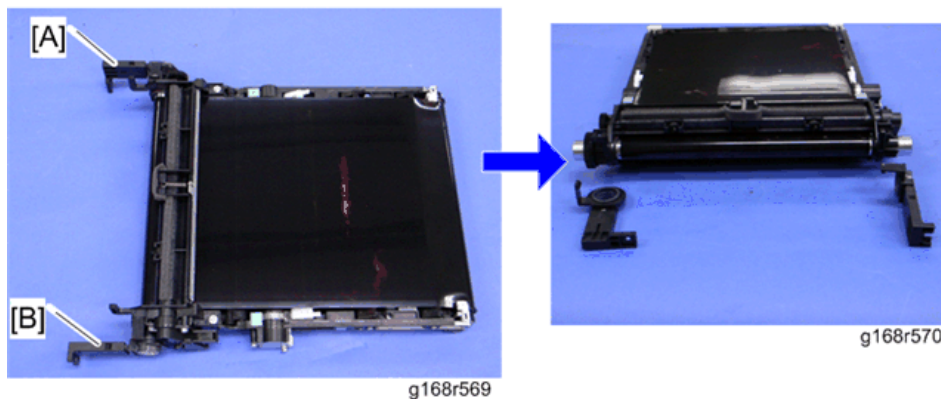

4. ITB cleaning unit [C] (  × 2)

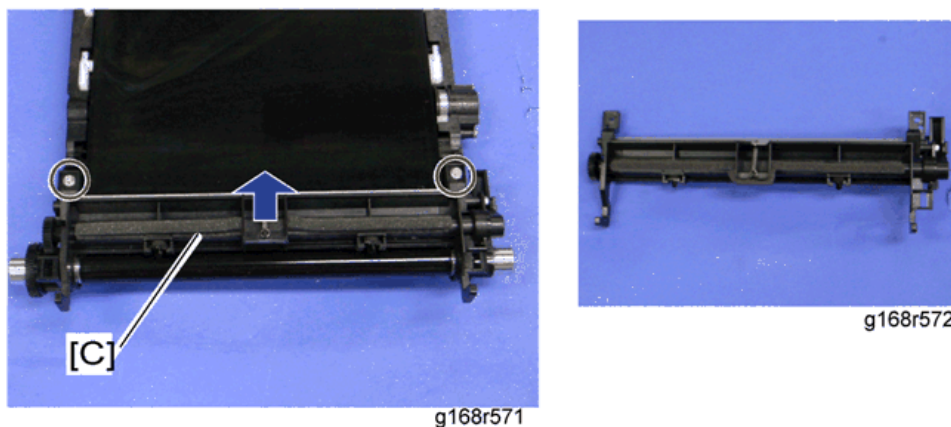

### 3.8.3 AGITATOR MOTOR

1. Rear cover (page 3-6 "Rear Cover")
2. Operation panel (page 3-69 "Operation Panel")
3. Right cover (page 3-8 "Right Cover")
4. Motor bracket [A] (  x 2)

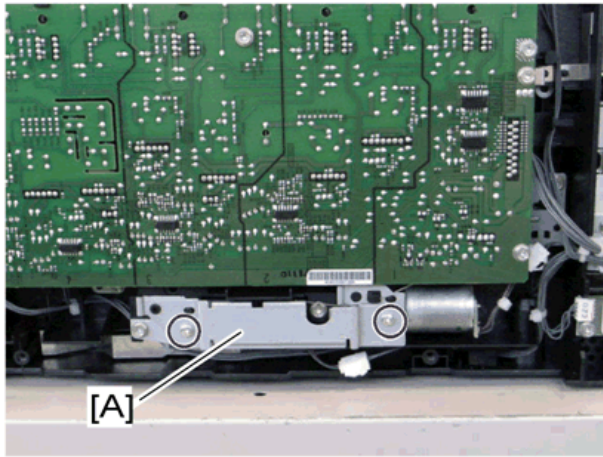

5. Agitator motor assembly [B] (  x 1,  x 1)

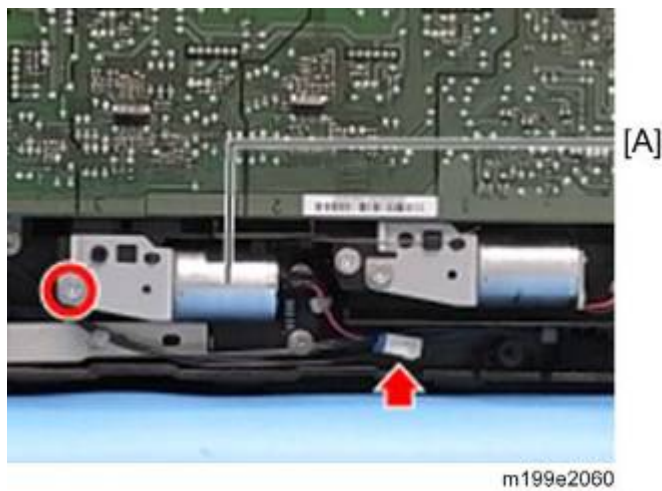

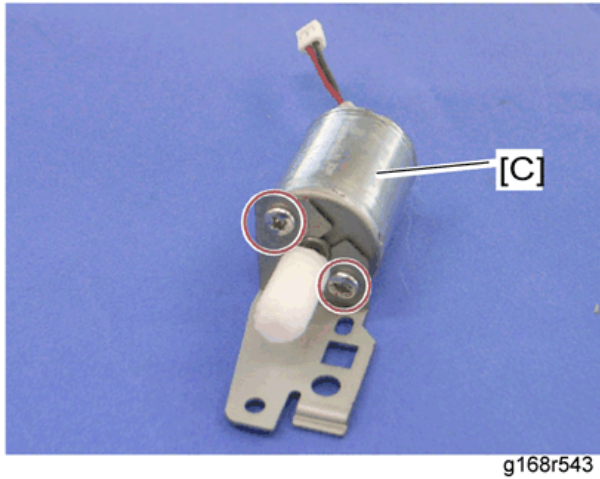

6. Agitator motor [C] (  x 2)



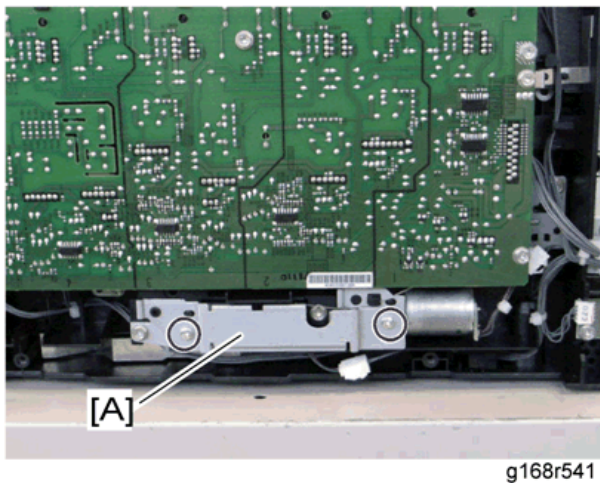

### 3.8.4 ITB (IMAGE TRANSFER BELT) CONTACT MOTOR

1. Rear cover (page 3-6 "Rear Cover")
2. Operation panel (page 3-69 "Operation Panel")
3. Right cover (page 3-8 "Right Cover")
4. Motor bracket [A] (  x 2)



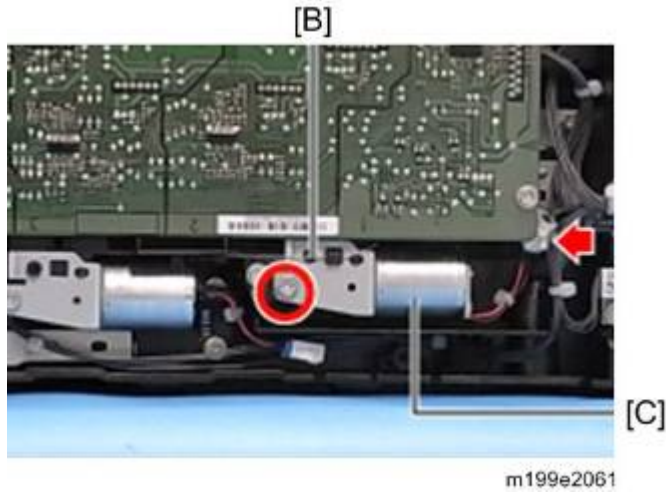

5. Release the wire [B].
6. ITB contact motor assembly [C] (  x 1,  x 1)



7. ITB contact motor [D] (  × 2 )



### 3.8.5 ITB (IMAGE TRANSFER BELT) CONTACT SENSOR

1. Rear cover (page 3-6 "Rear Cover")
2. Operation panel (page 3-69 "Operation Panel")
3. Right cover (page 3-8 "Right Cover")
4. High voltage power supply board (page 3-81 "High Voltage Power Supply Board")
5. ITB contact sensor assembly [A] (  x 1,  x 1)

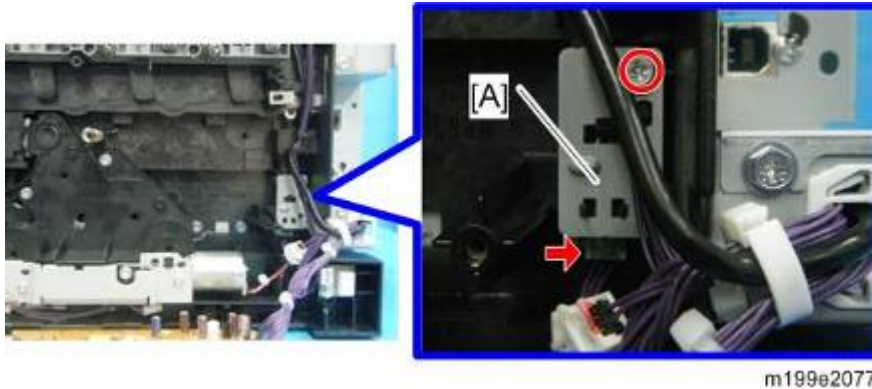

6. ITB contact sensor [B] (3hooks)

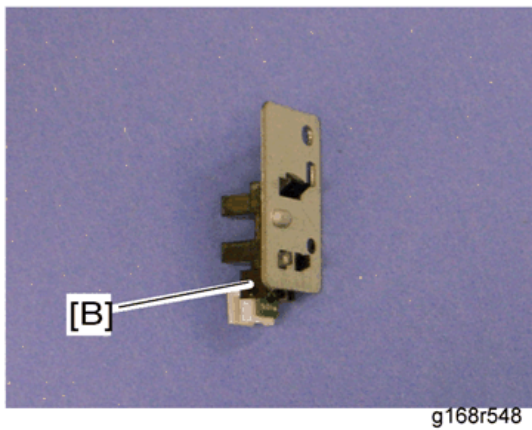

### 3.8.6 TM (TONER MARK) SENSOR BASE

1. Rear cover (page 3-6 "Rear Cover")
2. Controller box cover (page 3-63 "Controller Board")
3. Only for MF models: FCU and Speaker bracket (page 3-63 "Controller Board")
4. Disconnect CN306 on the EGB. (  x 1)



m199e2063

5. Remove all the AIO cartridges (page 3-32 "AIO Cartridge").
6. Image Transfer Belt Unit (page 3-37 "Image Transfer Belt Unit")
7. Harness cover [A] (hook)
8. TM sensor base [B]

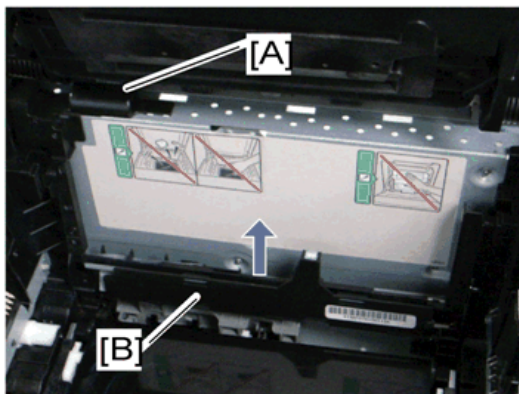

g168r573

### 3.8.7 WASTE TONER BOTTLE SET SENSOR

1. Rear cover (page 3-6 "Rear Cover")
2. Controller box cover (page 3-63 "Controller Board")
3. Only for MF models: FCU and Speaker bracket (page 3-63 "Controller Board")
4. Disconnect CN315 on the EGB
5. Remove two screws [A] for the waste toner sensor base.

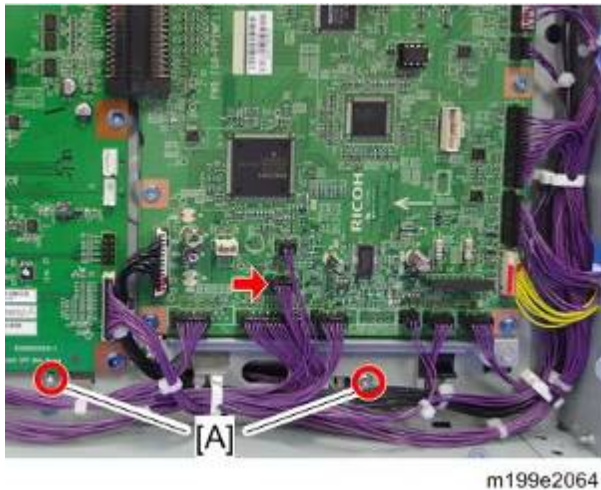

6. Remove all the AIO cartridges. (page 3-32 "AIO Cartridge")
7. Image transfer belt unit (page 3-37 "Image Transfer Belt Unit")
8. Waste toner sensor base [B]

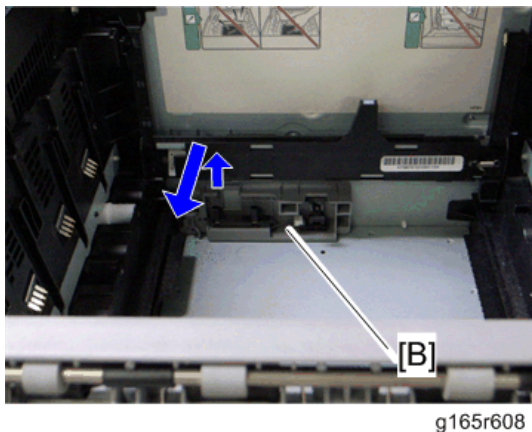

9. Waste toner bottle set sensor [C] (3hooks,  x 1)

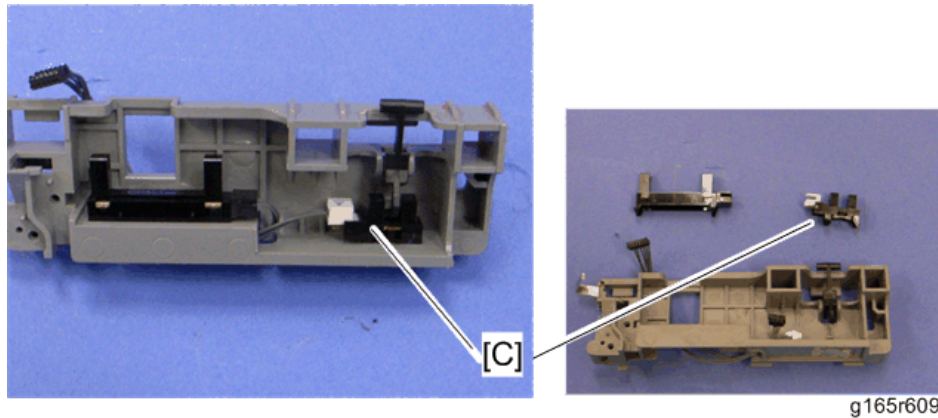

**Note**

- When reinstalling the waste toner bottle set sensor, connect it to the white connector of the harness.

### 3.8.8 WASTE TONER OVERFLOW SENSOR

- Waste toner sensor base (page 3-44 "Waste Toner Bottle Set Sensor")
- Waste toner overflow sensor [A] (3hooks,  x 1)

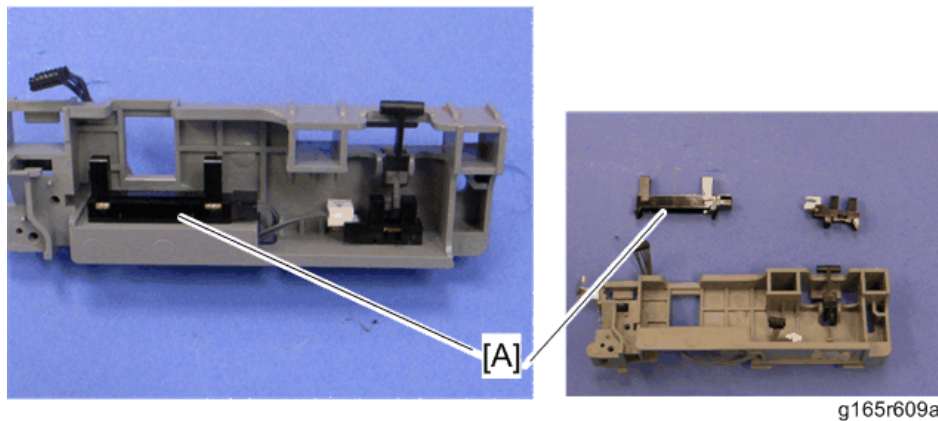

**Note**

- When reinstalling the waste toner overflow sensor, connect it to the black connector of the harness.



## 3.9 PAPER TRANSFER

### 3.9.1 TRANSFER UNIT

**Important**

- If you install a complete new unit, execute "Reset 2nd Transfer Unit" with the "Engine Maintenance" menu, otherwise a paper transfer error may occur.

1. Open the front cover.
2. Release the locks [A].
3. Transfer unit [B]

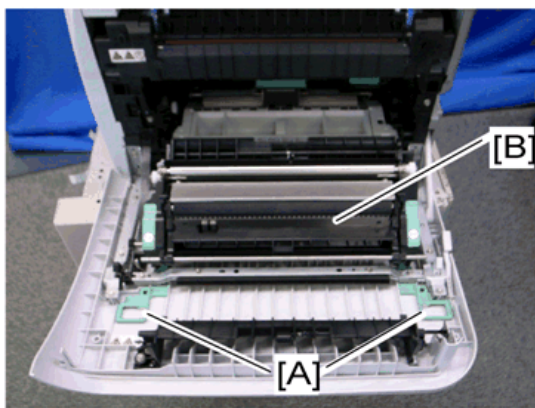

g168r549

4. If you install a complete new unit, execute "Reset 2nd Transfer Unit" with the "Engine Maintenance" menu (page 4-2 "Maintenance Mode Menu (MF Models)" or page 4-14 "Service Mode (Printer Models)").

### 3.9.2 TRANSFER ROLLER

#### ★ Important

- If you install a new roller, execute "Reset 2nd Transfer Unit" with the "Engine Maintenance" menu, otherwise a paper transfer error may occur.

- Transfer Unit (page 3-46 "Transfer Unit")
- Release the two hooks [A] at both sides of the transfer unit.



- Open the transfer roller unit [B] and remove it.

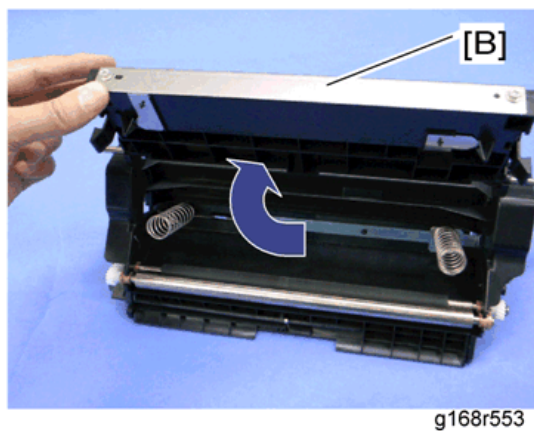

- Transfer roller assembly [C] (  × 2)



- Release the holder [D] at the left side of the transfer roller unit (hook).

6. Transfer roller [E]

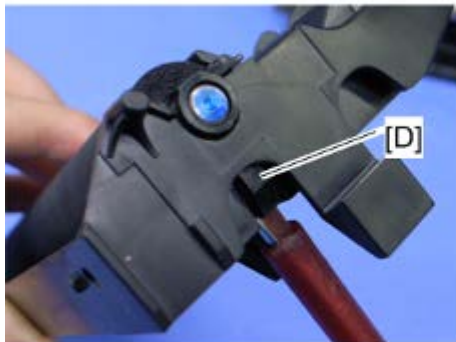

g168r555

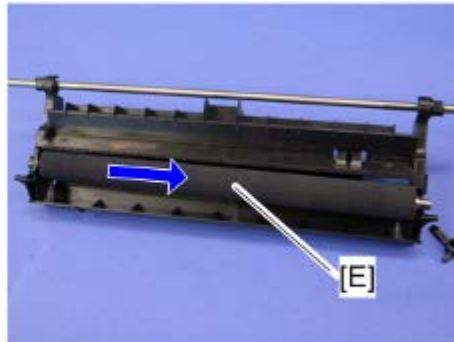

g168r556

7. Execute "Reset 2nd Transfer Unit" with the "Engine Maintenance" menu (page 4-2 "Maintenance Mode Menu (MF Models)" or page 4-14 "Service Mode (Printer Models)").

### 3.9.3 REGISTRATION ROLLER

1. Transfer unit (page 3-46 "Transfer Unit")
2. Transfer roller unit (page 3-47 "Transfer Roller")
3. Tension springs [A] (both sides)
4. Registration idle roller [B] (  $\odot$   $\times$  2, gear  $\times$  1, bushing  $\times$  2)
5. Registration roller [C] (  $\odot$   $\times$  2, gear  $\times$  2, bushing  $\times$  2)

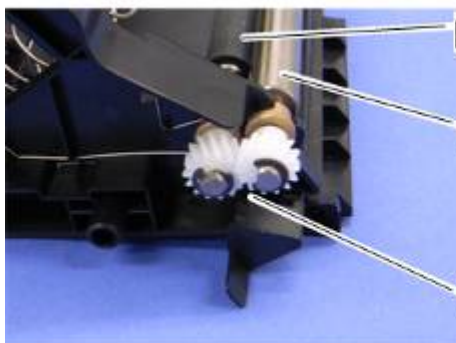

g168r557

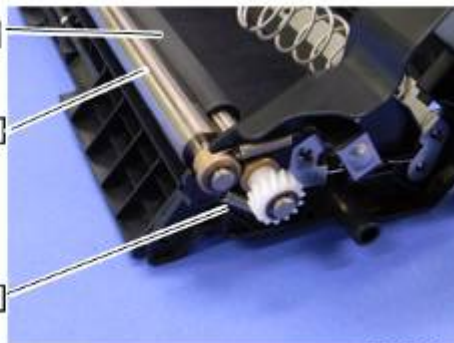

g168r558

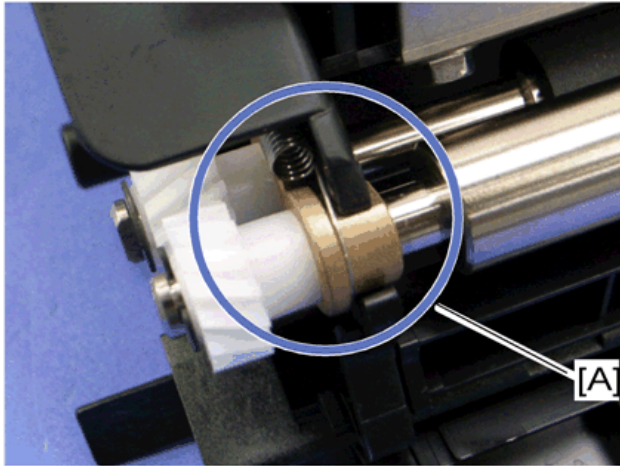

### Reassembling the registration roller unit

When installing the tension spring, make sure that the tension spring correctly hooks onto the bushing of the registration idle roller as shown below [A].



g168r559

### 3.9.4 REGISTRATION SENSOR

1. Rear cover (page 3-6 "Rear Cover")
2. Operation panel (page 3-69 "Operation Panel")
3. Right Cover (page 3-8 "Right Cover")
4. Registration sensor assembly [A] (  x 1,  x 1 )



m199e2078

5. Registration sensor [B] (hooks)

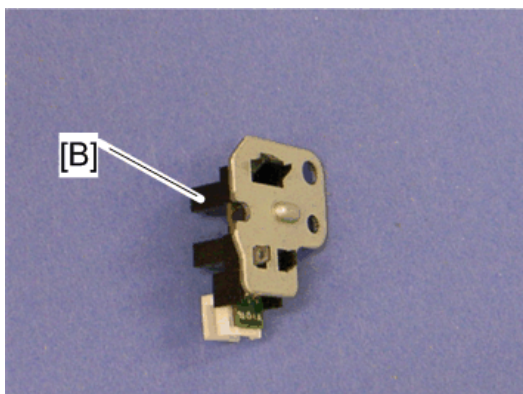

g168r562

### 3.9.5 REGISTRATION CLUTCH

1. Rear cover (page 3-6 "Rear Cover")
2. Left cover (page 3-8 "Left Cover")
3. Transport/Fusing motor (page 3-56 "Transport/Fusing Motor")
4. Registration clutch [A] (  x 1)

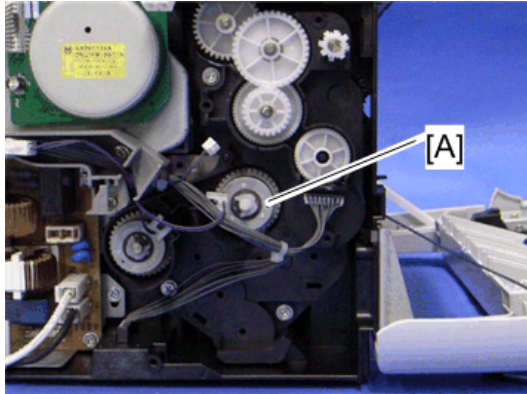

g165d592

## 3.10 IMAGE FUSING

### ⚠ CAUTION

- Make sure that the fusing unit is cool before you touch it. The fusing unit can be very hot.
- Make sure to restore the insulators, shields, etc after you service the fusing unit.

### 3.10.1 FUSING UNIT

#### ★ Important

- Execute "Reset Fuser Unit" with the "Engine Maintenance" menu if you replace the fusing unit, otherwise a fusing error may occur.

1. Open the front cover.

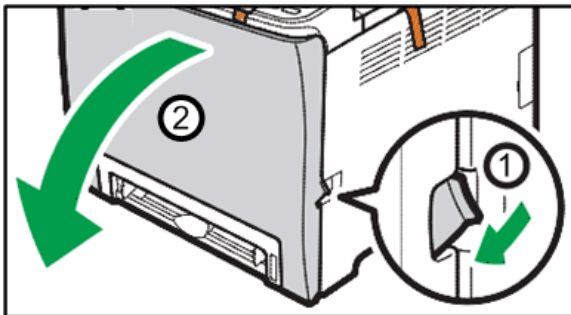

m199e2010

2. Left cover (page 3-8 "Left Cover")
3. Disconnect the connectors [A], [B].

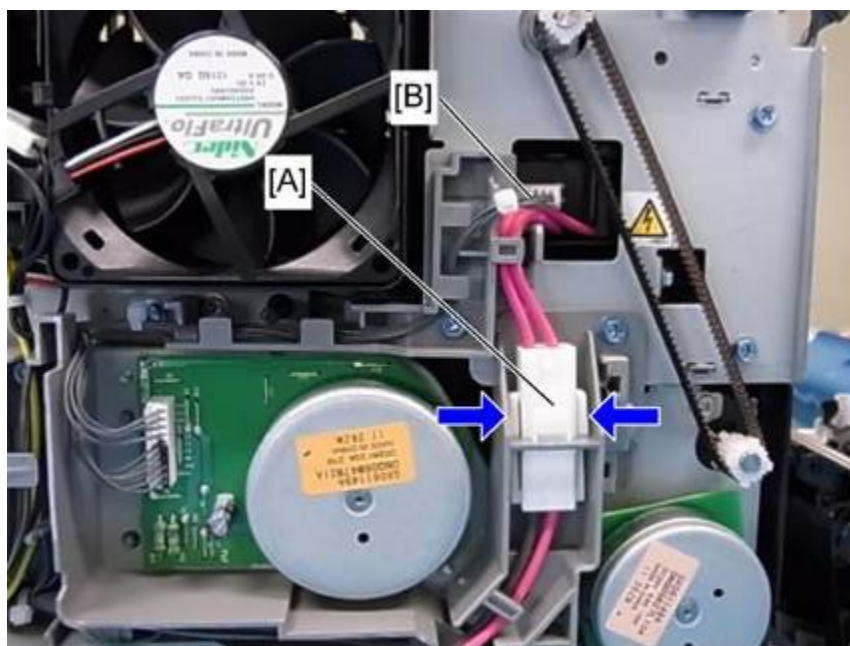

m0950005

4. Fusing unit [C] (  × 3)

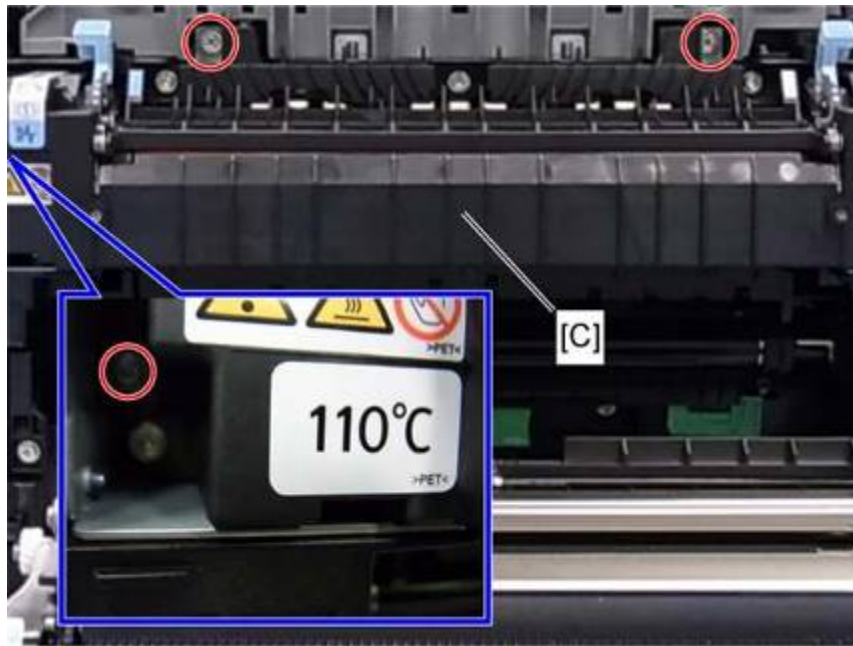

**Note**

- It is likely to remove a fusing unit cover screw instead of the lower left fixing screw by mistake. Make sure which screw should be removed before you do this step.

5. Execute "Reset Fuser Unit" with the "Engine Maintenance" menu (page 4-2 "Maintenance Mode Menu (MF Models)" or page 4-14 "Service Mode (Printer Models)") if the fusing unit is replaced.

### 3.10.2 FUSING LAMP

1. Fusing unit (page 3-51 "Fusing Unit")
2. Fusing front cover [A] (  x 3)

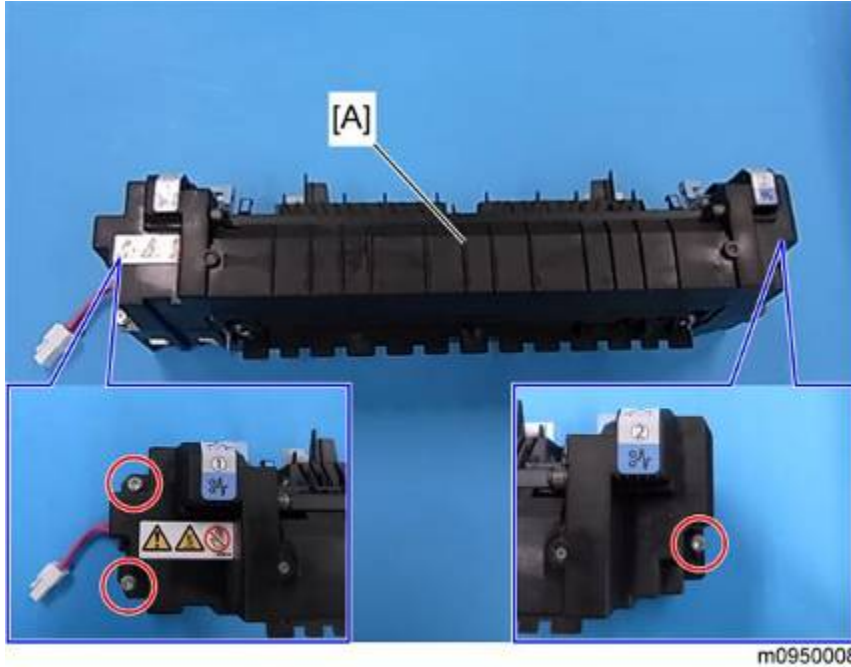

3. Fusing back cover [B] (  x 2)





4. Fusing lamp cable [C] (  x 2)

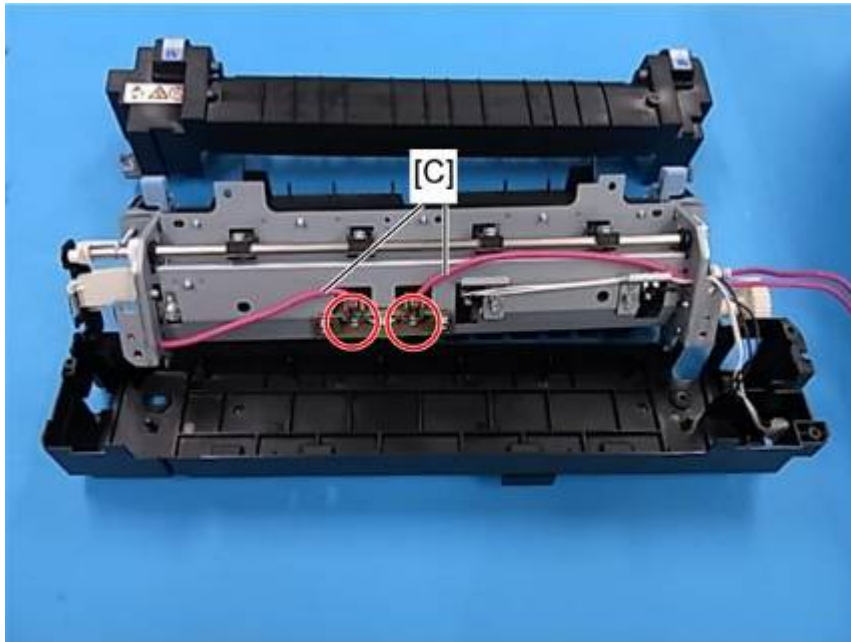

## Image Fusing



m0950010

5. Lamp right stay [E] (  × 1)
6. Lamp left stay [D] (  × 1)

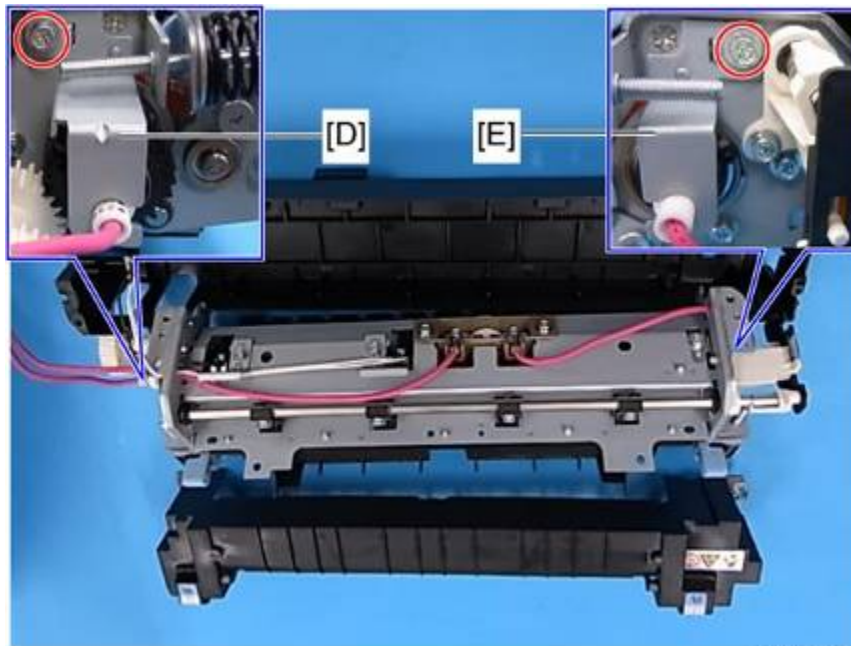

m0950011

7. Fusing lamp [E]

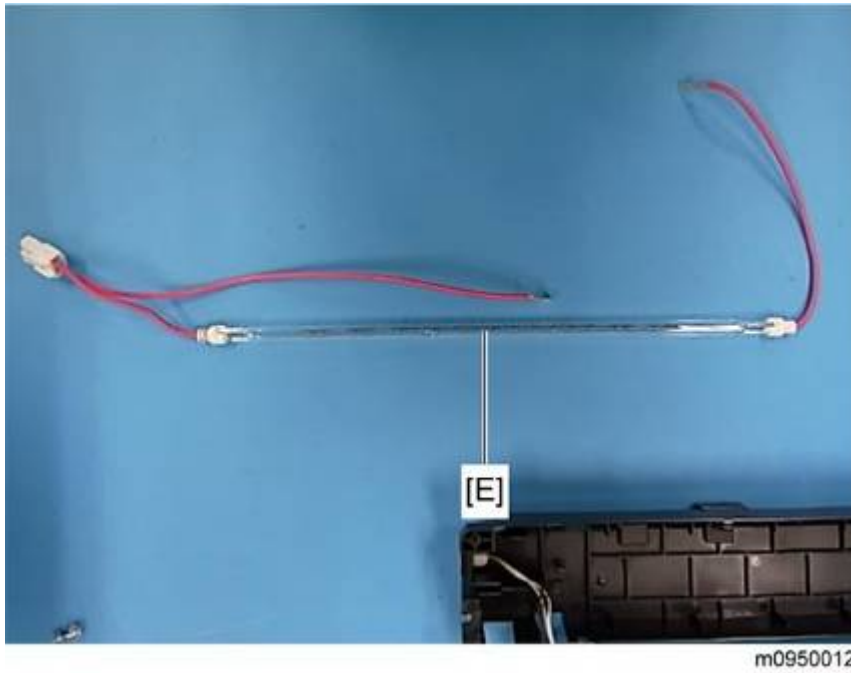

### ***When Reinstalling the Fusing Lamp***

The end of the fusing lamp [A], which shows the voltage and power ratings, must be placed at the left side of the fusing unit (fusing cable side).

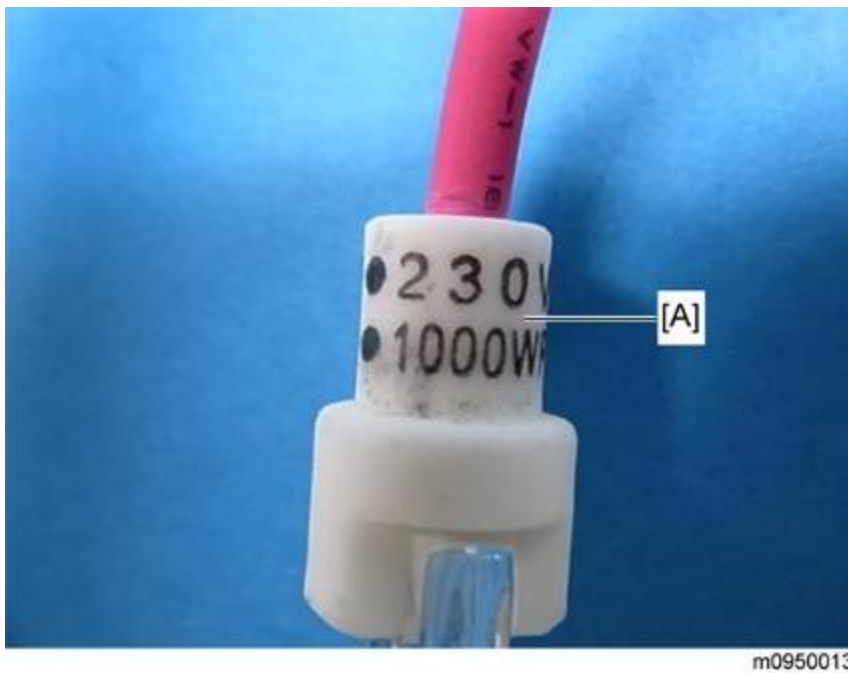

### ***When Reassembling the Fusing Unit***

Route the harness [A] as shown below when reinstalling the back cover [B].

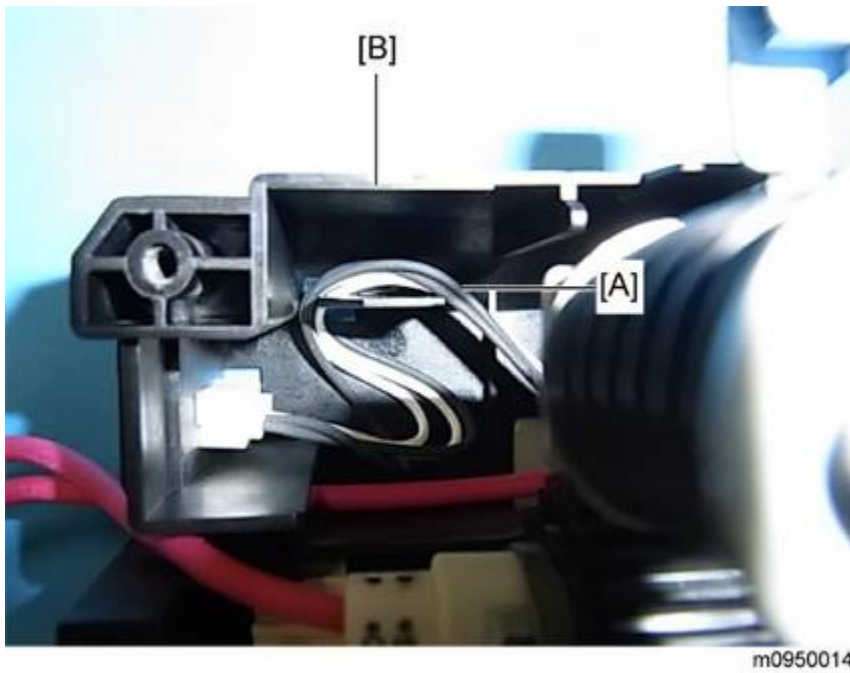

### **3.10.3 TRANSPORT/FUSING MOTOR**

1. Rear cover (page 3-6 "Rear Cover")
2. Left cover (page 3-8 "Left Cover")
3. Disconnect the fusing connector [A] and remove the fusing relay harness [B] (2 hooks).

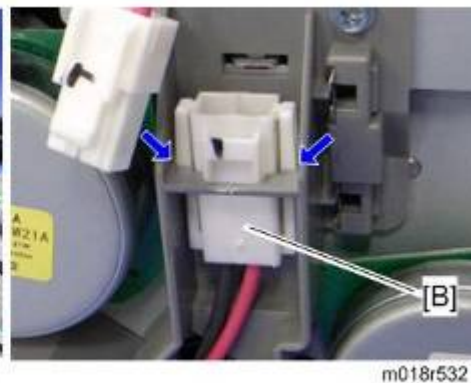
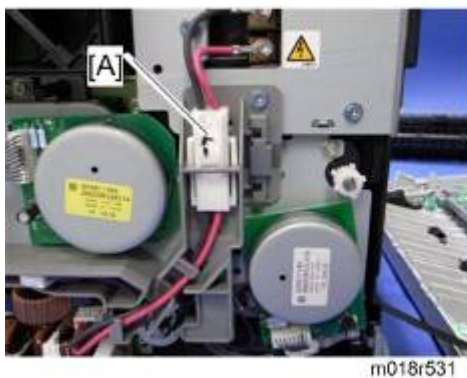

4. Fusing harness guide [C] (  x 2)
5. Duplex timing belt [D]



6. Transport/Fusing motor assembly [E] (  x 3,  x 3,  x 1, grounding plate [F] x 1 )

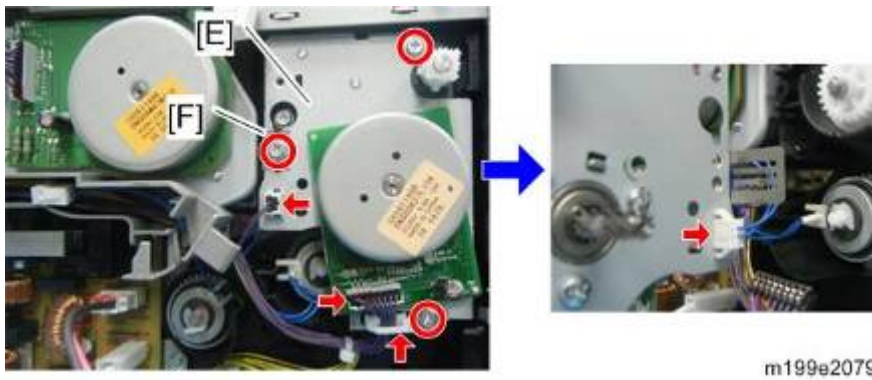

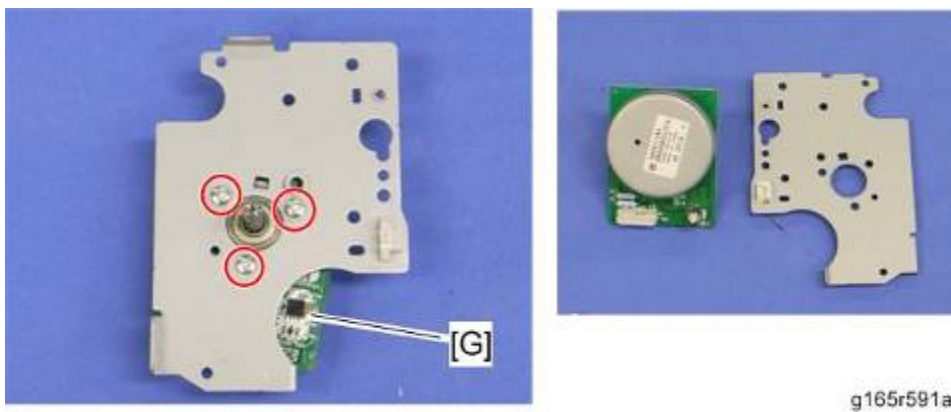

7. Transport/Fusing motor [G] (  x 3 )



## 3.11 PAPER FEED

### 3.11.1 PAPER FEED CLUTCH

1. Rear cover (page 3-6 "Rear Cover")
2. Left cover (page 3-8 "Left Cover")
3. Paper feed clutch [A] (  x 1,  x 1)

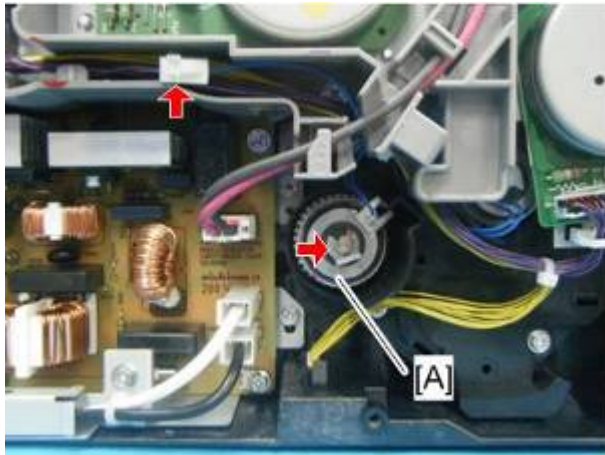

m199e2080

### 3.11.2 PAPER FEED ROLLER

1. Remove all the AIO cartridges.
2. Remove the waste toner bottle.
3. Rear cover (page 3-6 "Rear Cover")
4. Left cover (page 3-8 "Left Cover")
5. Paper feed clutch (page 3-58 "Paper Feed Clutch")
6. Close the top cover and front cover.
7. Pull out the tray.
8. Stand the machine with the rear side facing the table.



g165r597

9. Slide the paper feed shaft [A] to the left side. (  x 2)

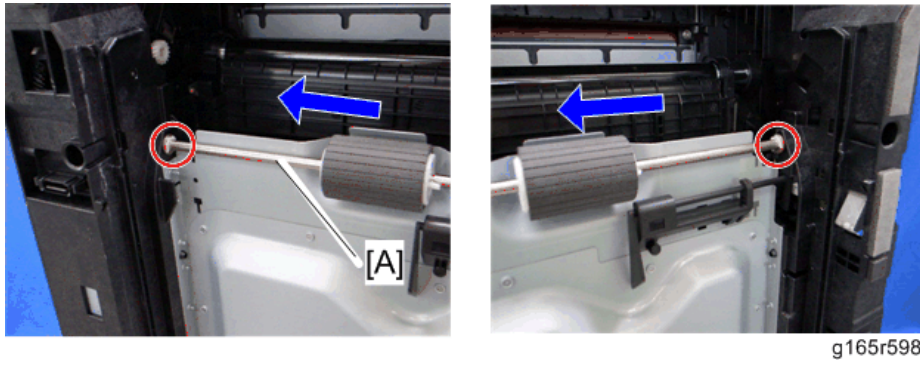

10. Paper feed roller [B] (hook)

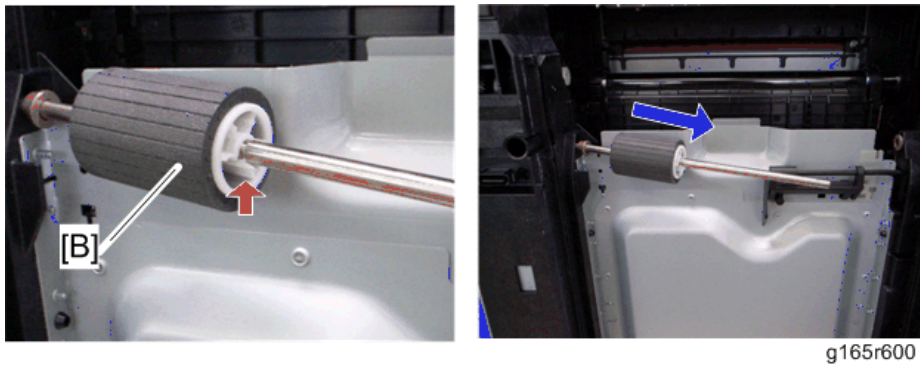

Replacement and Adjustment

3.11.3 SEPARATION PAD

1. Pull out the tray.
2. Push down the bottom plate [A].
3. Separation pad [B] (2hooks, spring x 1)

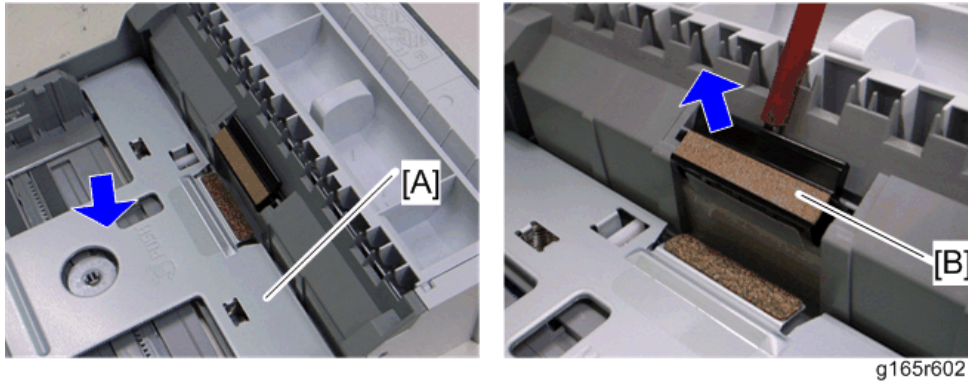

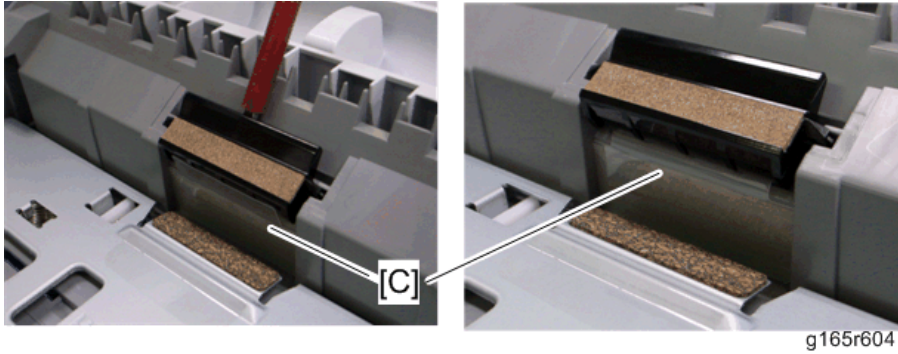

⚠ Note

- When reinstalling the separation pad, make sure that the Mylar [C] is not placed under the separation pad. The right side image below shows incorrect installation.



### 3.11.4 PAPER END SENSOR

1. Rear cover (page 3-6 "Rear Cover")
2. Operation panel (page 3-69 "Operation Panel")
3. Right cover (page 3-8 "Right Cover")
4. High voltage power supply board (page 3-81 "High Voltage Power Supply Board")
5. Paper end sensor assembly [A] (  x 1,  x 1)

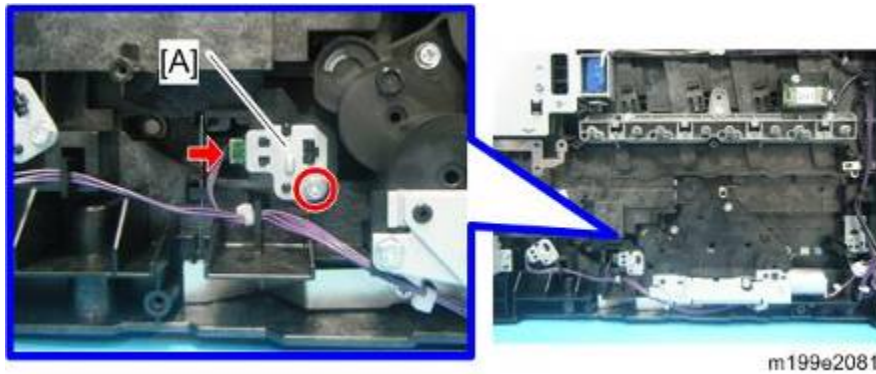

6. Paper end sensor [B] (3hooks)

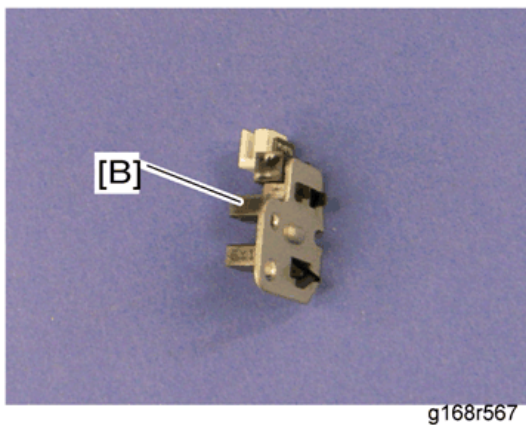

## 3.12 PAPER EXIT

### 3.12.1 PAPER EXIT ROLLER

1. Operation panel (page 3-69 "Operation Panel")
2. Remove the bushing [A] (  $\odot$  x 1)
3. Pull out the paper exit roller [B] from the right stay, and move its left side towards the front slightly, and then remove it from the mainframe. (  $\odot$  x 1)

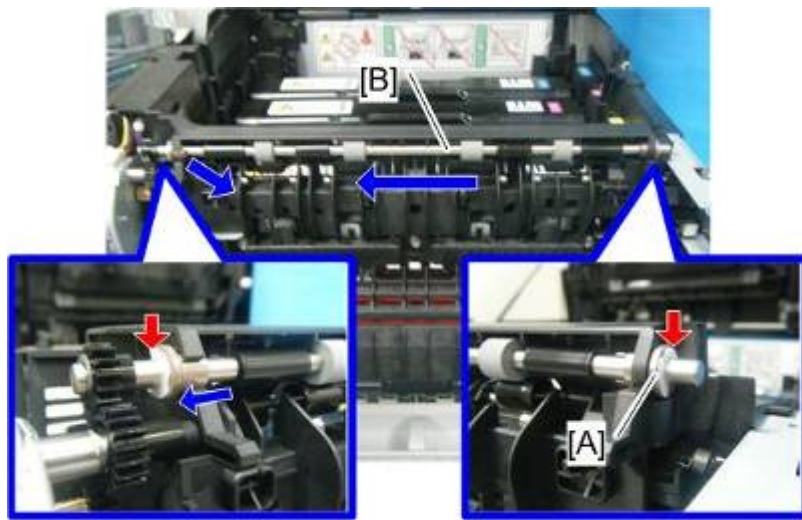

m199e2082

4. Remove the four exit guides [C] and gear [D]. (  $\odot$  x 1, bushing x 1)

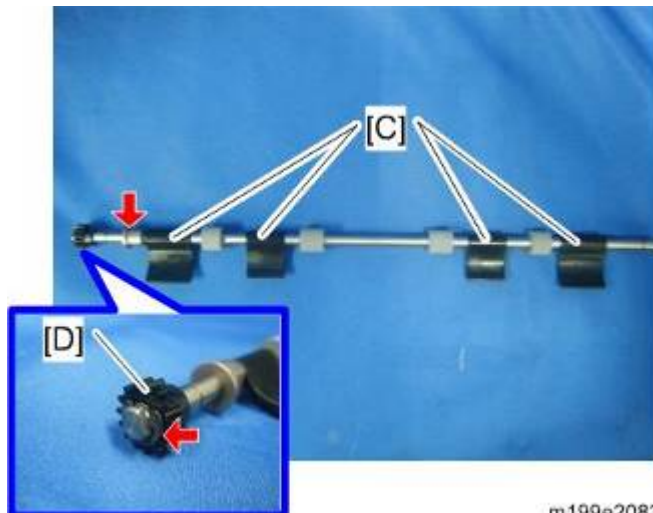

m199e2083



### 3.12.2 PAPER EXIT SENSOR

1. Rear cover (page 3-6 "Rear Cover")
2. Operation panel (page 3-69 "Operation Panel")
3. Right cover (page 3-8 "Right Cover")
4. Fusing stripper pawl solenoid assembly [A] (  × 4)

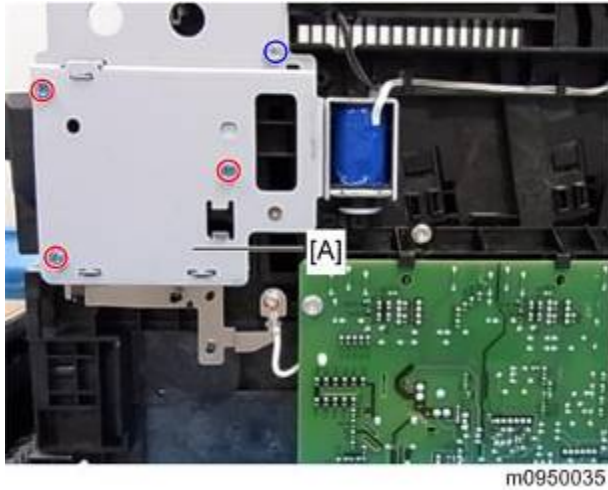

 **Note**

- The upper right screw in the above photo is different from other 3 screws.

5. Remove the paper exit sensor [C] while lightly pressing the feeler [B] in the direction shown by the arrow (4 hooks,  × 1).

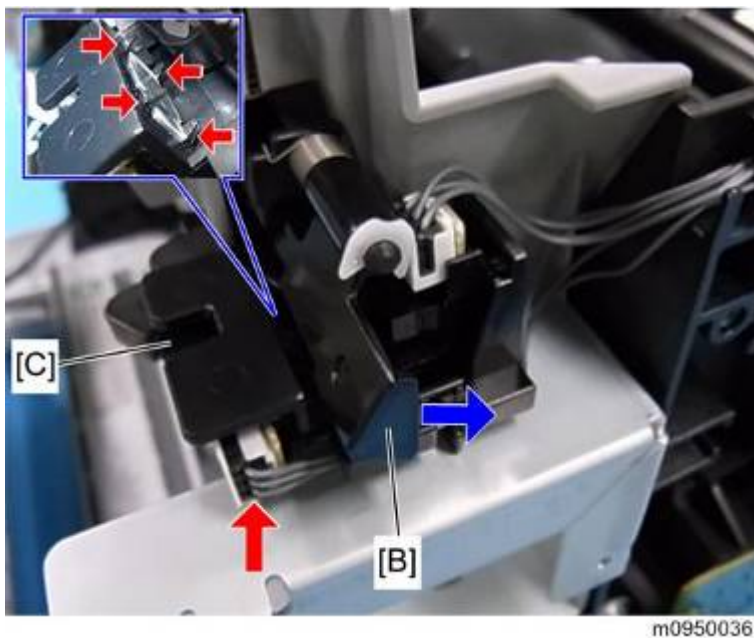

## 3.13 ELECTRICAL COMPONENTS

### 3.13.1 CONTROLLER BOARD

#### *Controller Board (Printer Models)*

1. Rear cover (page 3-6 "Rear Cover")
2. Controller box cover [A] (  × 6)

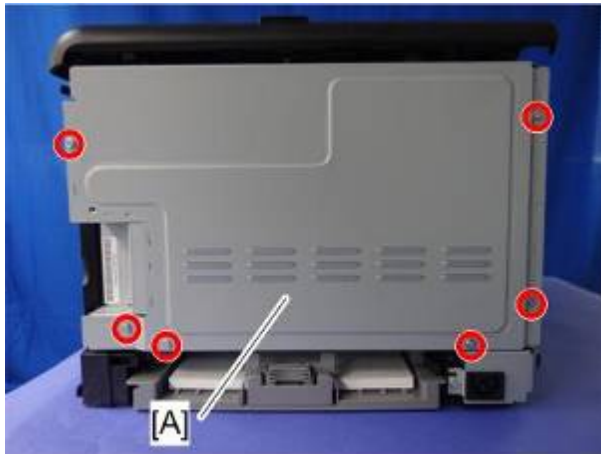

m199e2032

3. Interface bracket [B] (  × 3)



m199e2033

#### Note

- The middle screw in the above photo is different from the other 2 screws.

4. Controller board [C] (  × 5,  × 3)



m199e2034

### **Controller Board (MF Models)**

1. Rear cover (page 3-6 "Rear Cover")
2. Controller box cover [A] (  x 7 )

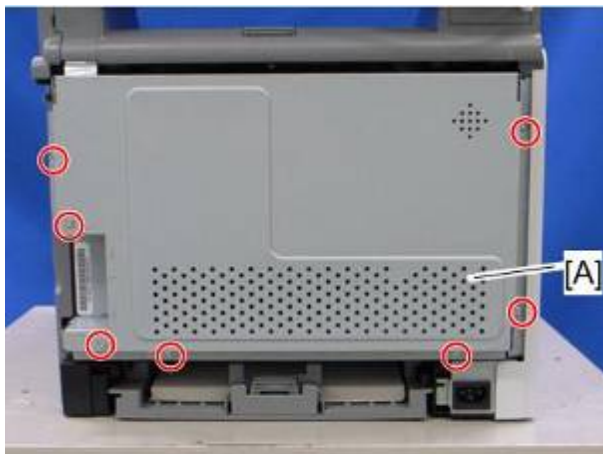



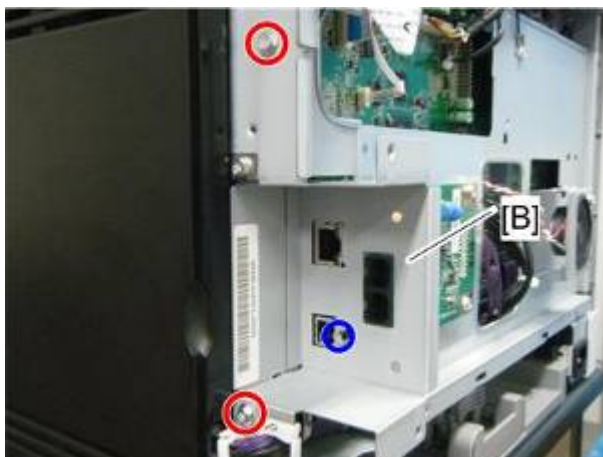

g165r505a

3. Interface bracket [B] (  x 3 )



m199e2035

↓ Note

- The middle screw in the above photo is different from the other 2 screws.
4. Disconnect the two flat cables [C] with the Ferrite core [D]. (  x2, 2 hooks)
  5. Ground wire [E] (  x 1)
  6. FCU and Speaker bracket [F] (  x 4,  x 1,  x 2)

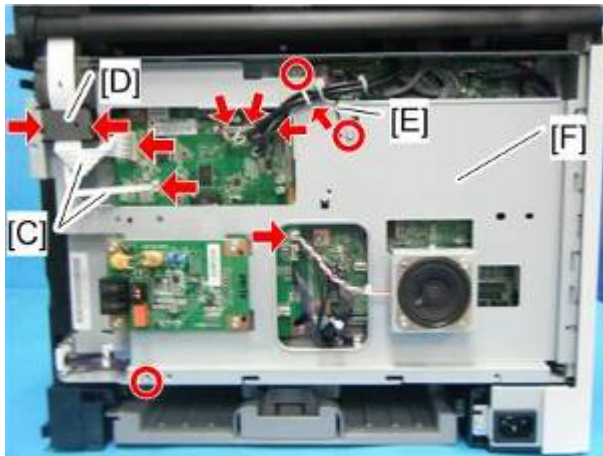

m199e2036



7. Controller board [G] (  x 6,  x4)



m199e2037

### 3.13.2 EGB (ENGINE BOARD)

#### *EGB (Printer Models)*

1. Rear cover (page 3-6 "Rear Cover")
2. Controller box cover (page 3-63 "Controller Board")
3. EGB [A] (  x 6, all s)

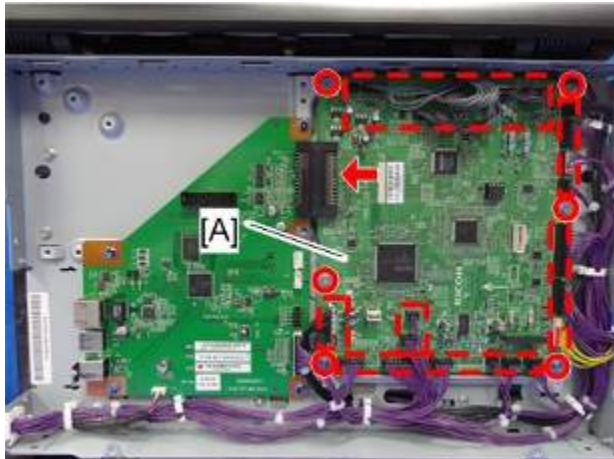

m199e2039

4. EEPROM [B]



m0950024

#### When installing the new EGB

1. Remove the EEPROM from the old EGB.
2. Install it on the new EGB with the mark [A] pointing to the right side of the board after you replace the EGB.





3. Replace the EEPROM if the EEPROM on the old EGB is defective.

**⚠ CAUTION**

- Keep the EEPROM away from objects that can cause static electricity. Static electricity can damage EEPROM data.
- Make sure that the EEPROM is correctly installed on the EGB.

### ***EGB (MF Models)***

1. Rear cover (page 3-6 "Rear Cover")
2. Controller box cover (page 3-63 "Controller Board")
3. FCU and Speaker bracket (page 3-63 "Controller Board")
4. EGB [A] (all s,  x 6)

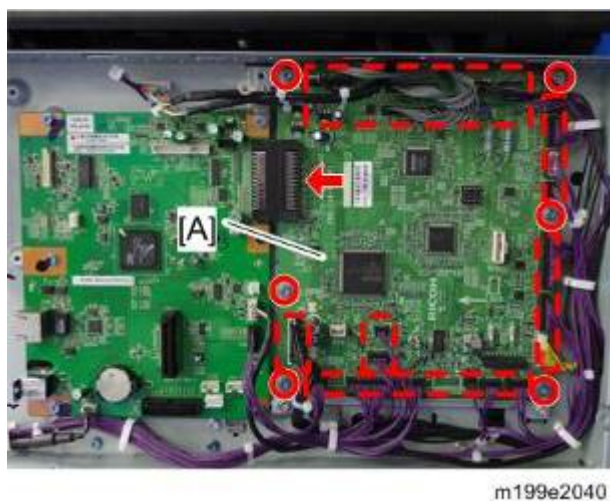

5. EEPROM [B]



**When installing the new EGB**

1. Remove the EEPROM from the old EGB.
2. Install it on the new EGB with the mark [A] pointing to the right side of the board after you replace the EGB.



3. Replace the EEPROM if the EEPROM on the old EGB is defective.

**⚠ CAUTION**

- Keep the EEPROM away from any objects that can cause static electricity. Static electricity can damage EEPROM data.
- Make sure that the EEPROM is correctly installed on the EGB.

### 3.13.3 FCU (ONLY FOR MF MODELS)

1. Rear cover (page 3-6 "Rear Cover")
2. Controller box cover (page 3-63 "Controller Board")
3. Interface bracket (page 3-63 "Controller Board")
4. FCU [A] (  x 4)

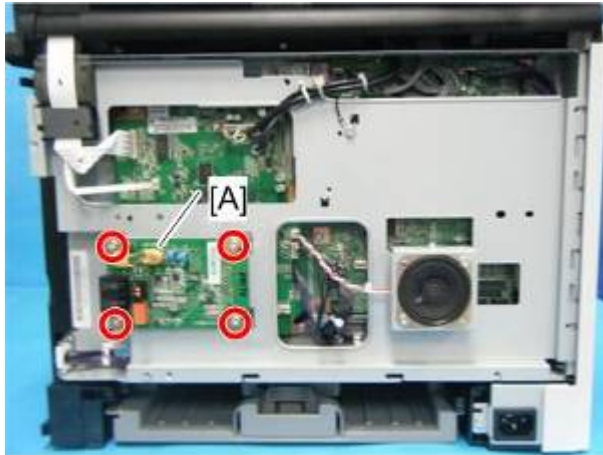

m199e2041

### 3.13.4 OPERATION PANEL

1. Open the front cover.

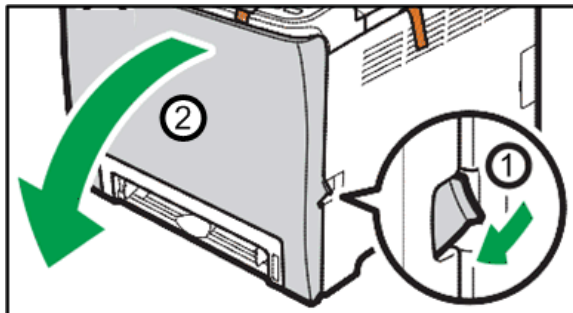

m199e2010

2. Front harness cover [A] (  x1)



m199e2042

3. Open the top cover.



**Printer Models**

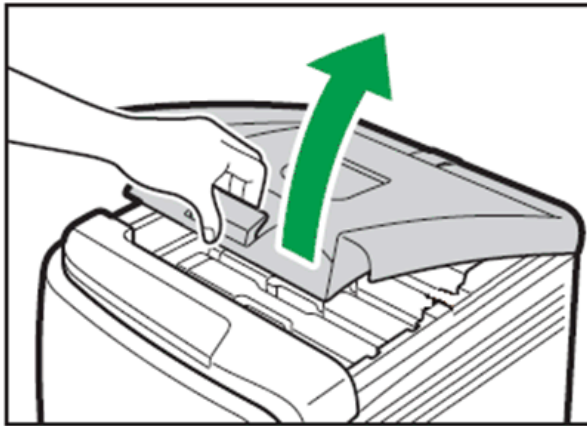

m199e2008

**MF Models**

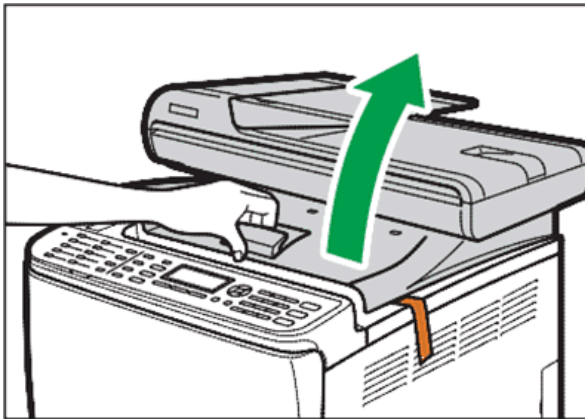

m199e2009

4. Operation panel [B] (  x 1,  x1)

**Printer Models**





**MF Models**



Replacement and Adjustment

**3.13.5 OPU**

**OPU (Printer Models)**

1. Operation panel (page 3-69 "Operation Panel")
2. Remove the key and display assembly [A] from the operation panel. (  x 2, hooks,  x 1,  x 1)



3. OPU [B] (  x 3)

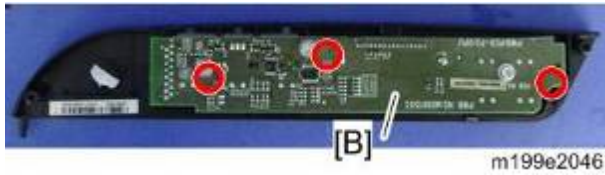

**OPU (MF Models)**

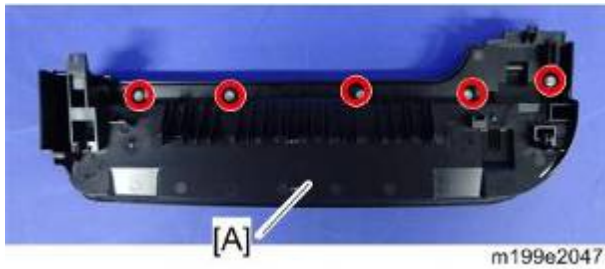

1. Operation panel (page 3-69 "Operation Panel")
2. Remove the rear cover [A] from the operation panel. (  x 5)

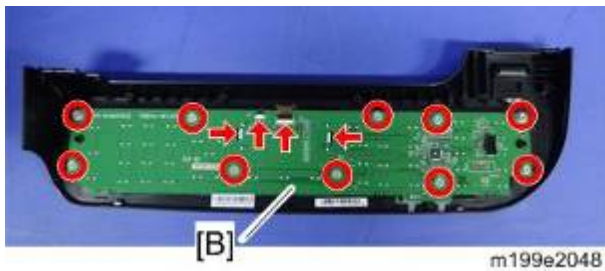

3. OPU [B] (  x 10,  x 2, 2 hooks)



### 3.13.6 WI-FI BOARD

1. Rear cover (page 3-6 "Rear Cover")
2. Operation panel (page 3-69 "Operation Panel")
3. Right cover (page 3-8 "Right Cover")
4. Remove the Wi-Fi Board [A] with the bracket. (  x 1,  x1)

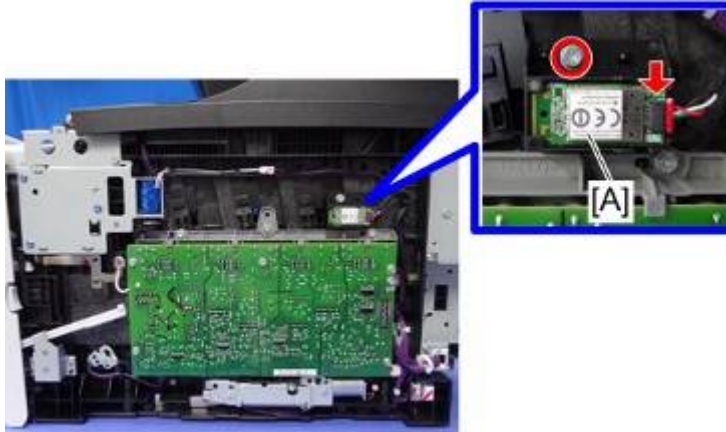

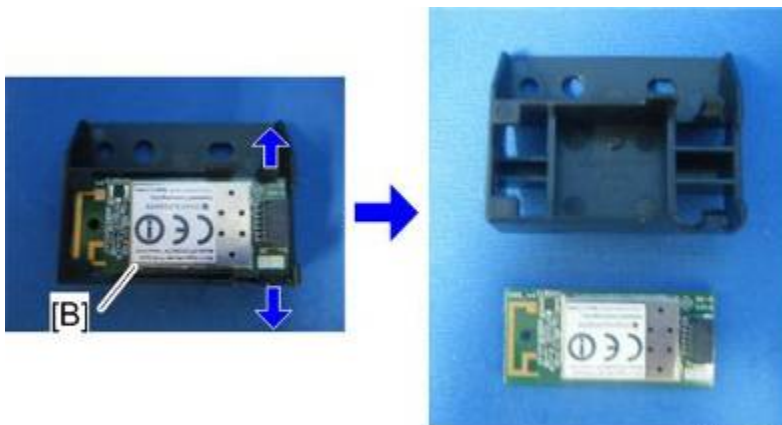

m199e2038

5. Remove the Wi-Fi Board [B] from the bracket.



m199e2084

### 3.13.7 INTERLOCK SWITCHES

1. Left cover (page 3-8 "Left Cover")
2. Interlock switch base [A] (  x 4,  x 4)

 **Note**

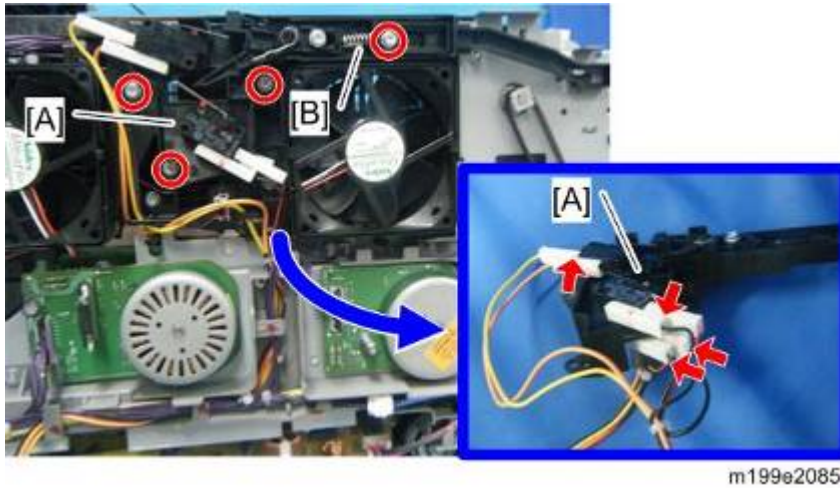

- Removing the spring [B] first makes this procedure easier.
- Remove all the connectors after the interlock switch base has been removed.

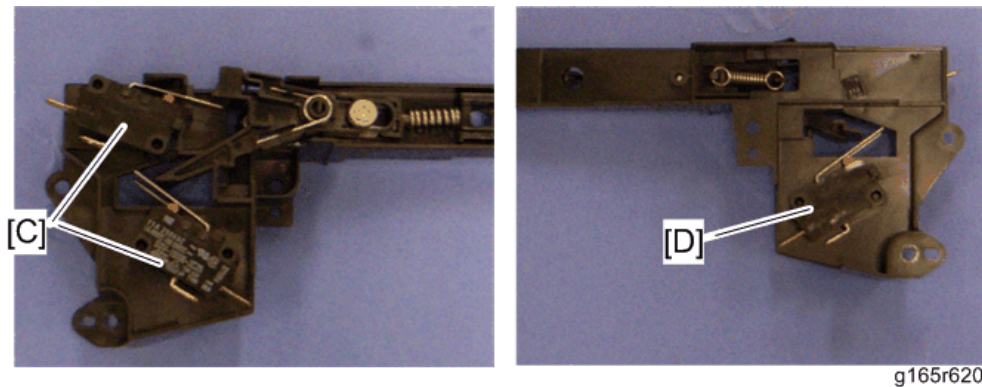

3. Two interlock switches [C] at the outside of the base and one interlock switch [D] at the inside of the base (hook x1 each)



### 3.13.8 FUSING FAN MOTOR

1. Left cover (page 3-8 "Left Cover")
2. Interlock switch base (page 3-74 "Interlock Switches")
3. Fusing fan base [A] (  x 2,  x 1 )

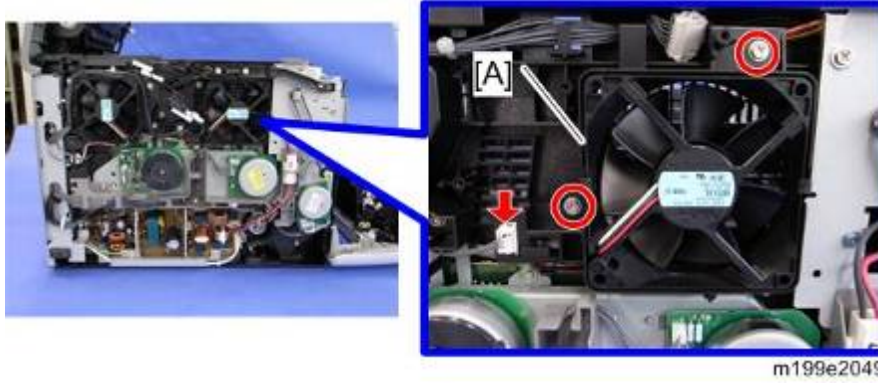

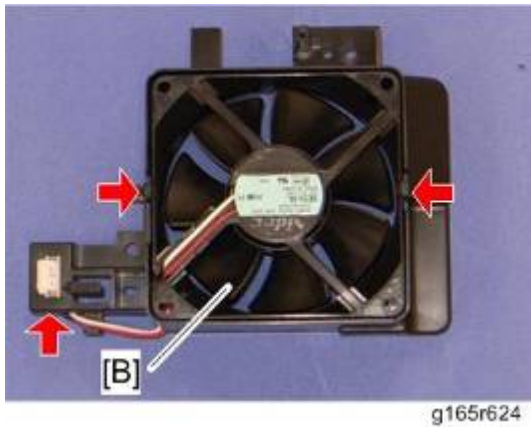

4. Fusing fan motor [B] (2hooks,  x 1)



#### CAUTION

- Install the fusing fan motor with its decal facing the outside of the machine.

### 3.13.9 FUSING STRIPPER PAWL SOLENOID

1. Open the front cover.
2. Open the top cover.
3. Rear cover (page 3-6 "Rear Cover")
4. Operation panel (page 3-69 "Operation Panel")
5. Right cover (page 3-8 "Right Cover")
6. Fusing stripper pawl solenoid assembly [A] (  x 4,  x 1 )

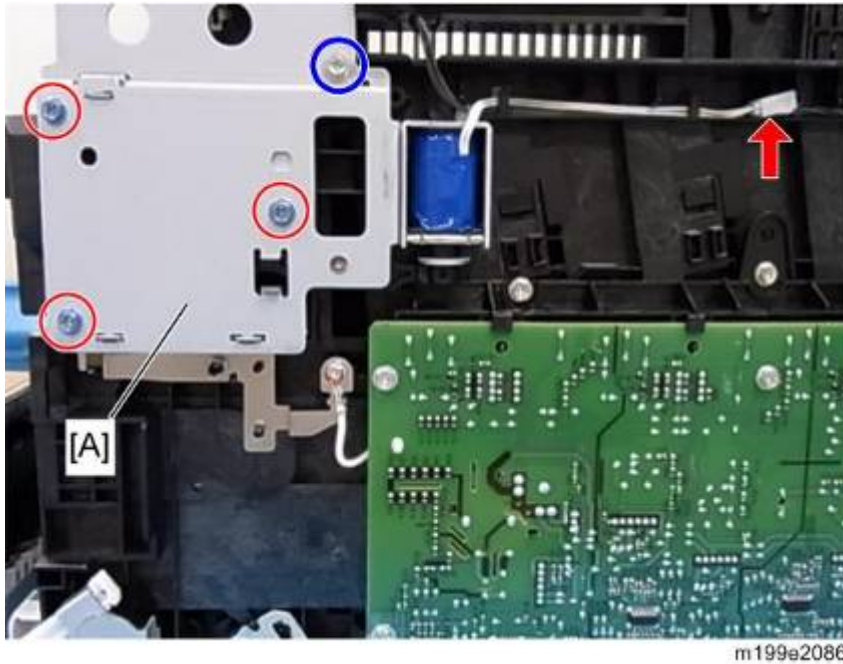

 **Note**

- The upper right screw in the above photo is different from other 3 screws.

7. Fusing stripper pawl solenoid [B] (  x 2 )

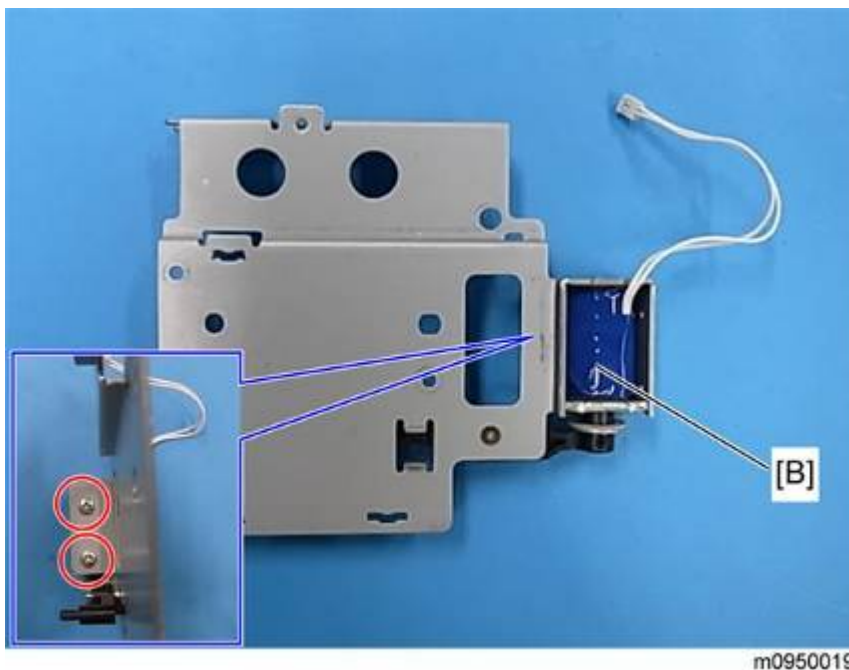



### 3.13.10 FUSING PRESSURE RELEASE SENSOR

1. Fusing stripper pawl solenoid assembly (page 3-76 "Fusing Stripper Pawl Solenoid")
2. Fusing pressure release sensor [B] (  [A] × 1, 4hooks)

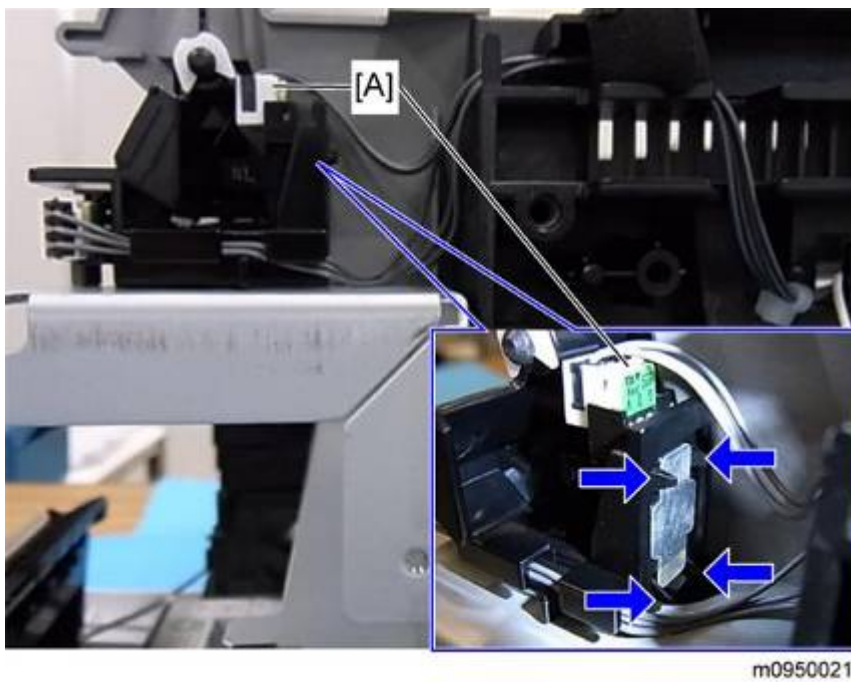



### 3.13.11 LSU FAN MOTOR

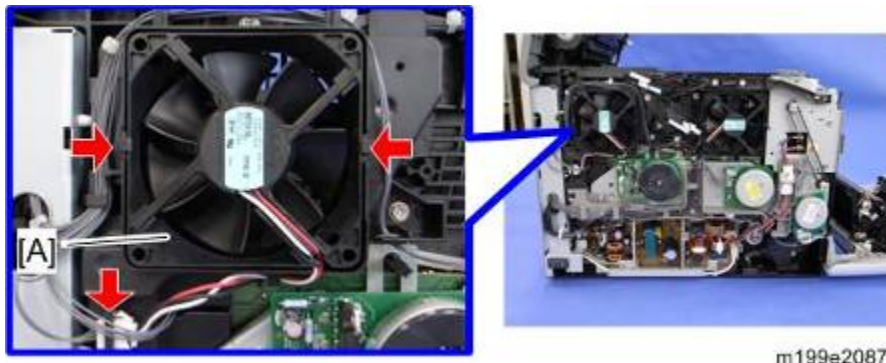

1. Left cover (page 3-8 "Left Cover")
2. LSU fan motor [A] (2hooks,  x 1)



#### CAUTION

- Install the LSU fan motor with its decal facing the outside of the machine.

### 3.13.12 ID CHIP BOARD

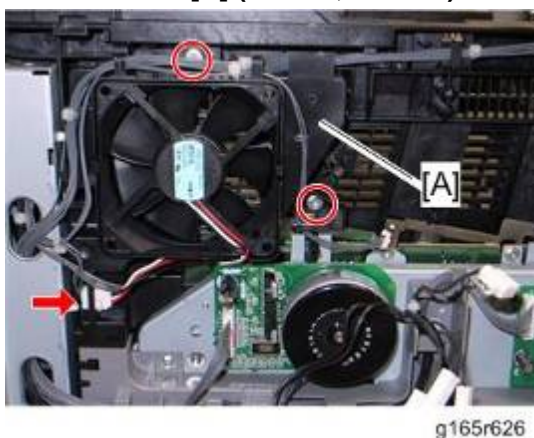

1. Rear cover (page 3-6 "Rear Cover")
2. Left cover (page 3-8 "Left Cover")
3. Controller box cover (page 3-63 "Controller Board")
4. Only for MF Models: FCU and Speaker bracket (page 3-63 "Controller Board")
5. Disconnect the connector (CN305) on the EGB.
6. Interlock switch base (page 3-74 "Interlock Switches")
7. Fusing fan base (page 3-75 "Fusing Fan Motor")
8. Drive unit (page 3-32 "Black AIO Motor")
9. Take the harnesses aside around the LSU fan base [A].
10. LSU fan base [A] (  x 2,  x 1)

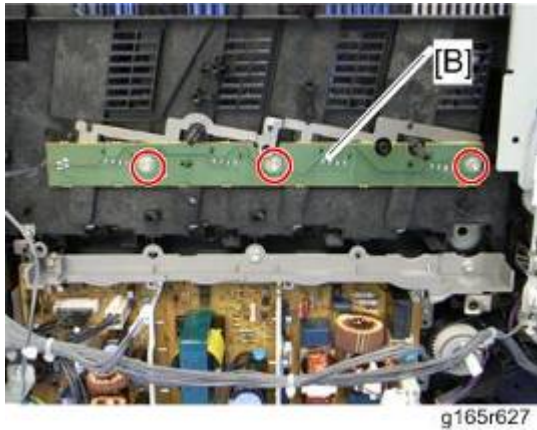

11. ID Chip Board [B] (  x 3)



### 3.13.13 PSU

1. Left cover (page 3-8 "Left Cover")
2. Harness guide (page 3-32 "Black AIO Motor")
3. Ground cable [A] (  × 1 )
4. Power cord bracket [B] (  × 2 )

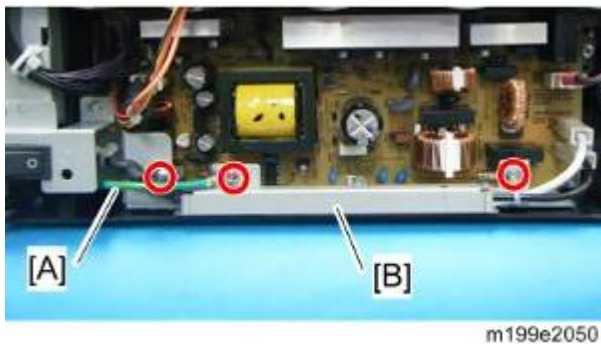

5. Power switch assembly [C] (  × 3,  × 2 )





 Note

- The left screw in the above photo is different from other 2 screws.

6. PSU assembly [D] (  × 4,  × 5 )

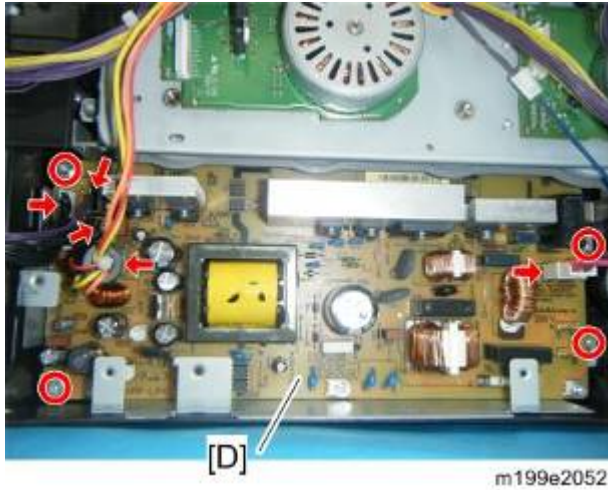

Electrical Components



7. PSU [E] (  x 4 )



### 3.13.14 HIGH VOLTAGE POWER SUPPLY BOARD

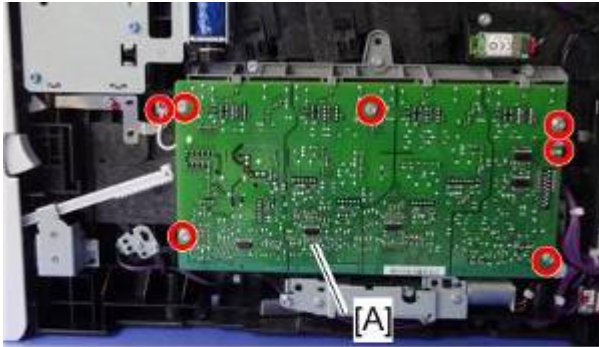

1. Rear cover (page 3-6 "Rear Cover")
2. Operation panel (page 3-69 "Operation Panel")
3. Right cover (page 3-8 "Right Cover")
4. High Voltage Power Supply Board [A] (  x 6, ground screw x 1,  x 1)



m199e2054

Replacement and Adjustment

### 3.13.15 TEMPERATURE/HUMIDITY SENSOR

1. Rear cover (page 3-6 "Rear Cover")
2. Operation panel (page 3-69 "Operation Panel")
3. Right cover (page 3-8 "Right Cover")
4. Temperature/Humidity sensor [A] (  x 1,  x 1)

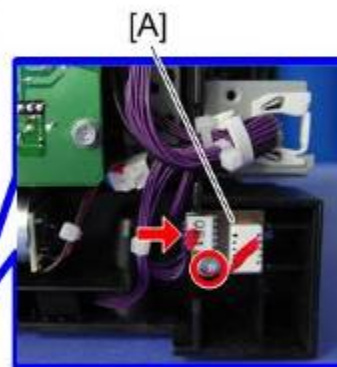
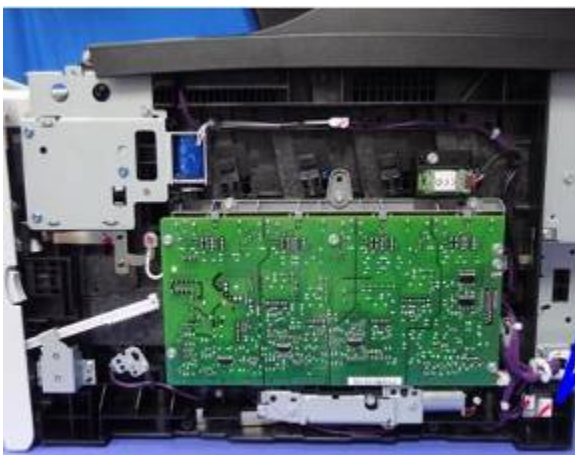

m199e2055



### 3.13.16 DUPLEX MOTOR

1. Operation panel (page 3-69 "Operation Panel")
2. Left cover (page 3-8 "Left Cover")
3. Interlock switch base (page 3-74 "Interlock Switches")
4. Disconnect the fusing connector [A] and remove the fusing relay harness [B] (2hooks).





5. Fusing harness guide [C] (  x 2)

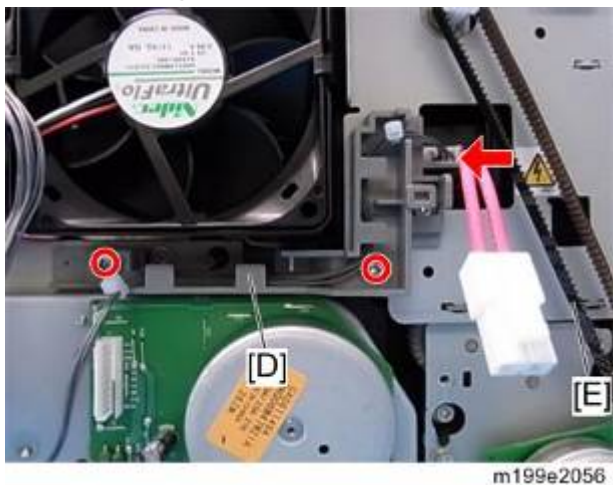

6. Fusing thermistor harness guide [D] (  x 2,  x 1)
7. Duplex timing belt [E]



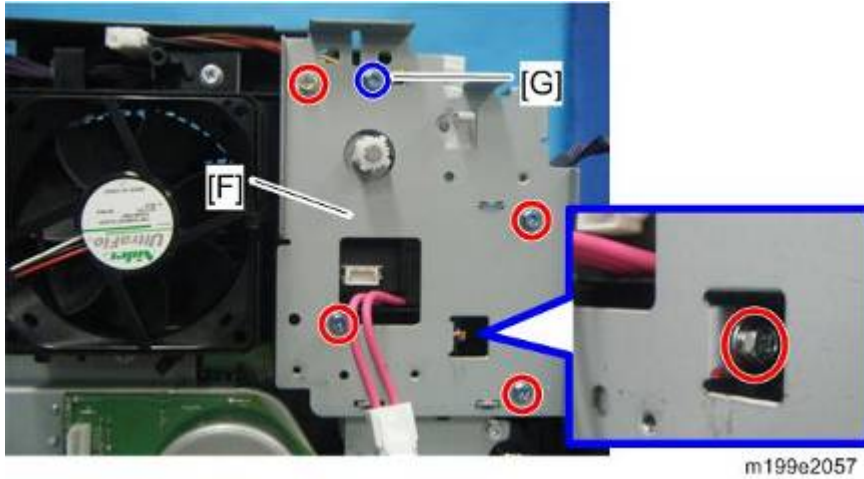

8. Left bracket [F] (Printer models:  x 5, MF Models:  x 6 including [G])

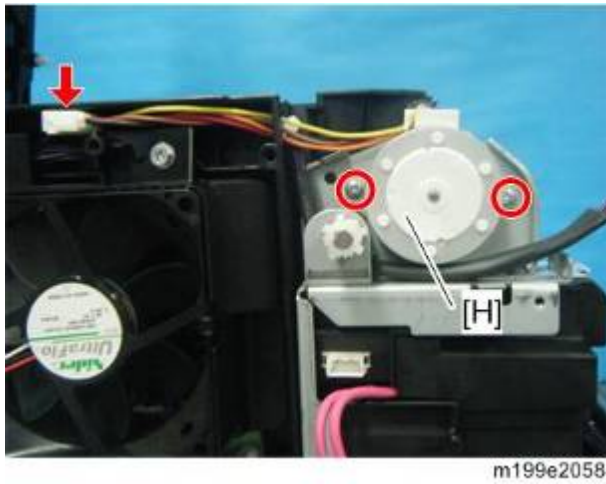

9. Duplex motor [H] (  x 2,  x 1)



### 3.13.17 SPEAKER (ONLY FOR MF MODELS)

1. Rear cover (page 3-6 "Rear Cover")
2. Controller box cover (page 3-63 "Controller Board")
3. Speaker [A] (  x 2,  x 1 )

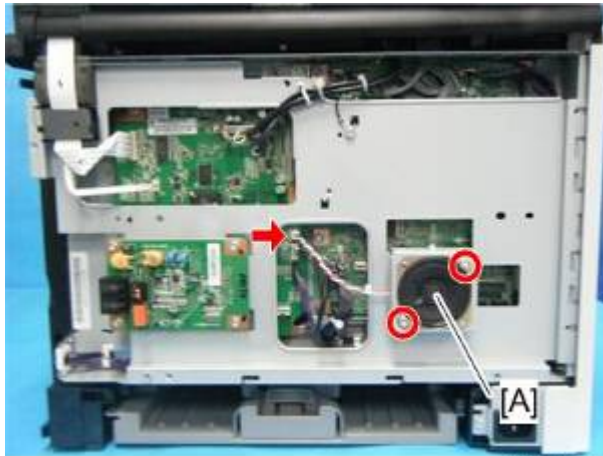

m199e2059

### 3.13.18 EEPROM

#### ↓ Note

- Replacement and Reinstallation procedures for the EEPROM are included in the page 3-66 "EGB (Engine Board)" replacement procedure. Refer to page 3-66 "EGB (Engine Board)" for details.

When replacing an old EEPROM with a new EEPROM, EEPROM setting is required. Follow the EEPROM setting procedure described below.

#### ★ Important

- **Do the following steps 1 to 9 with the front cover of the machine open. After completing these steps, turn off the machine.**

1. Open the front cover and turn on the machine.

#### ↓ Note

- The machine may issue an error code (because the cover is open), but continue this procedure.

2. Enter "Engine Maintenance" in the "Maintenance Mode Menu".
3. Select "Init Engine EEPROM" item and execute it to initialize the EEPROM.
4. Press the "Clear/Stop" key to exit the "Engine Maintenance" menu.
5. Select the "Serial No." item, and then input a serial number.

#### ↓ Note

- Ask your supervisor about how to access the serial number input display.

6. Exit the serial number input display, and then enter "Engine Maintenance" again.
7. Select "Destination", and then select a destination.
8. Select "Model", and then select a model.
9. Select "PnP Name", and then select a plug and play name.
10. Select "LSU Adjustment", and then input the LSU (laser optics housing unit) setting values if they are available.
11. Turn off the machine.
12. Turn on the machine with the front cover open.
13. Enter "Engine Maintenance" in the "Maintenance Mode Menu" again.
14. Close the front cover.
15. Select "Trans. Belt Adjust", and then execute "Trans. Belt Adjust" to adjust the ITB (Image Transfer Belt) unit.
16. Select "Fuser SC Detect", and then select "ON" or "OFF" for the consecutive fusing jam detection.



↓ **Note**

- The default setting is "OFF". Select "ON" only if the customer wants to use this feature.
17. Select "Registration", and then adjust the registration for each direction (vertical and horizontal direction) and tray if necessary.
  18. Select "2nd Transfer Fuser Temp", and then adjust the transfer roller bias and the temperature reduction of the fusing unit for each paper type and for the front and back sides. The default settings for normal operation are all '0'.
  19. Perform "Color Registration" in the "Engine Maintenance" menu.
  20. Turn the power off and on.

↓ **Note**

- MUSIC will be performed automatically.
21. Print out the test chart (page 3-25 "Laser Optics Housing Unit"), and make sure that MUSIC was performed successfully.

↓ **Note**

- If MUSIC is not performed successfully, see "If MUSIC has not been performed successfully" (page 3-25 "Laser Optics Housing Unit").
22. If necessary, adjust the registration settings for the front and rear sides of each paper tray in the "Engine Maintenance" menu.
  23. Exit "Engine Maintenance".

### Checking that MUSIC was Performed Correctly

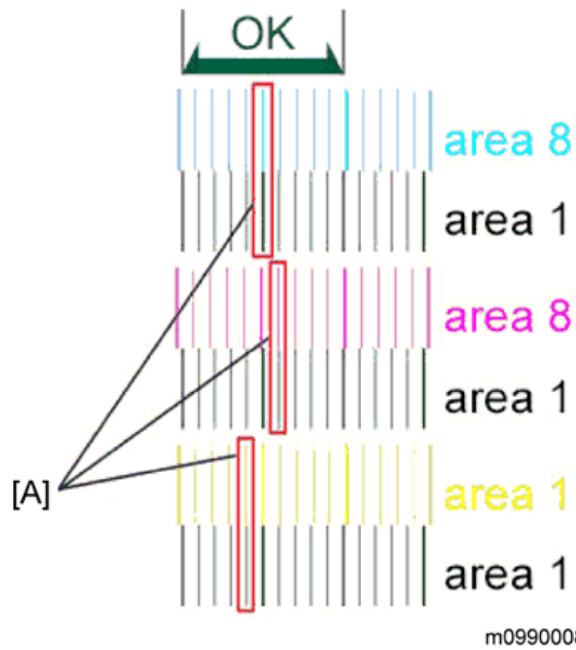

Four sets of vertical lines appear on the test chart (C and k, M and k, Y and k...). In each set, look for vertical lines that are aligned within the region defined by "OK".

If all sets have at least one set of vertical lines that are aligned [A], MUSIC was successful.

# SYSTEM MAINTENANCE REFERENCE

REVISION HISTORY		
Page	Date	Added/Updated/New
		None

## 4. SYSTEM MAINTENANCE REFERENCE

### 4.1 SERVICE MENU

#### 4.1.1 OVERVIEW

These models have several service menus. Each service menu has several adjustment items. This section explains how to enter each service menu and what you can do in each service menu. Each menu is classified into two "Modes" depending on how you enter the service menus.

#### **Menu Mode**

- "Menu Mode" can be executed by pushing a sequence of keys.

Maintenance Mode Menu (MF models) Service Mode (Printer models)	This is a menu for maintenance and service.
--	---

#### **Special Mode**

- "Special Mode" can be executed if you press certain keys at the same time as you turn the power on.

DFU Factory SP Factory Default Settings Menu (only for MF models)	<p>This is a menu for initializing all information stored in the controller, except for some counters.</p> <ul style="list-style-type: none"> <li>▪ These counters are initialized: Print/Scan/Copy/Fax functional Counter, Jam Counter</li> <li>▪ These counters are not initialized: Printer/Scanner Engine Counter, which are printed in the "Configuration Page".</li> </ul> <p>After initializing with this menu, when the user powers on the machine, the Initial Setup Menu appears. The user must select Language in Country in this menu.</p>
Fax Service Test Menu (only for MF models)	This is a menu for checking the fax mode.

Size Mismatch Detection	Specifies whether to detect the paper size mismatch
-------------------------	---

### 4.1.2 MAINTENANCE MODE MENU (MF MODELS)

#### *Menu List*

Display Info		
Model Name		Displays the Model Name, Depends on Engine Firmware Settings
FW Version	CTL FW Version	Displays the Firmware Version
	FAX FW Version	Displays the Facsimile Firmware Version. (M203 doesn't support this)
	Engine FW Version	Displays the Engine Firmware Version
Counter	Printer Counter	Displays the following counters of the printer engine. Total Page/ Color Image/ Black Image
	Scanner Counter	Displays the sum total of scanner counters for each mode. Total Page/ Black Page/ Color Page / ADF Used
	Jam Counter	Displays the number of paper jams at each location. Total/ ADF/ Printer Output Bin/ Internal/ Tray1 / Tray2
	Coverage	Displays the number of paper misfeeds with tray 1 or tray 2. Coverage1 (Tray 1)/ Coverage2 (Tray2)

Print Reports	
G3 Protocol dump list	G3 protocol dump of the latest communication is printed. (M203 doesn't support this) Off (Default)/ Error/ On

Engine Maintenance		
Toner Limit	Text	Determines the maximum amount of ink/toner you can use in any area of your text. This is where you are controlling exactly how much ink will be used during printing. [200 to 400 / 250 (Default)/ 10/step]
	Graphic	Determines the maximum amount of ink/toner you can use in any area of your graphic. This is where you are controlling exactly how much ink will be used during printing. [200 to 400 / 250 (Default)/ 10/step]
	Image	Determines the maximum amount of ink/toner you can use in any area of your image. This is where you are controlling exactly how much ink will be used during printing. [200 to 400 / 250 (Default)/ 10/step]
P <sub>N</sub> P Name	NA Model: RICOH/ 'nul' EU Model: RICOH/ NRG/ LANIER ASIA Model: RICOH/ LANIER China Model: RICOH [0x00 to 0x7F / - / -]	
Destination	Sets the destination and updates the engine setting. DOM/ NA (Default)/ EU/ CHN/ TAIWAN/ ASIA / LA	

2nd Transfer Fuser Temp.	Media Type	Sets the Media type. Plain paper, Thick Paper 2, Middle Thick Paper, Thick Paper 1, Recycled Paper, Color Paper, Letterhead, Preprinted Paper, Prepunched Paper, Label Paper, Bond Paper, Cardstock, Envelope, Thick Post, Thin Paper
	2nd Transfer Front	Adjusts the transfer roller current, based on the default value. [-15 to 15 / 0 (Default) / 1 $\mu$ A/step]
	2nd Transfer Back	Adjusts the transfer roller current, based on the default value. [-15 to 15 / 0 (Default) / 1 $\mu$ A/step]
	Fuser Temperature	Adjusts the temperature of the fusing unit, based on the default value. [-30 to 0 / 0 (Default) / 2°C/step]
Registration	Horiz. Tray1	Adjusts the horizontal registration for tray 1. If the machine settings are reset to the factory defaults, this value does not change. [-15 to 15 / 0 (Default) / 1 mm/step]
	Vert.Tray1	Adjusts the vertical registration for tray 1. If the machine settings are reset to the factory defaults, this value does not change. [-15 to 15 / 0 (Default) / 1 mm/step]
	Horiz.Tray2	Adjusts the horizontal registration for tray 2. If the machine settings are reset to the factory defaults, this value does not change. [-15 to 15 / 0 (Default) / 1 mm/step]
	Vert.Tray2	Adjusts the vertical registration for tray 2. If the machine settings are reset to the factory defaults, this value does not change. [-15 to 15 / 0 (Default) / 1 mm/step]

	Horiz Bypass Tray	Adjusts the horizontal registration for the bypass tray. If the machine settings are reset to the factory defaults, this value does not change. [-15 to 15 / 0 (Default) / 1 mm/step]
	Vert Bypass Tray	Adjusts the vertical registration for the bypass tray. If the machine settings are reset to the factory defaults, this value does not change. [-15 to 15 / 0 (Default) / 1 mm/step]
	Horiz.Dup Back	Adjusts the horizontal registration for the back side in duplex mode. If the machine settings are reset to the factory defaults, this value does not change. [-15 to 15 / 0 (Default) / 1 mm/step]
	Vert.Dup Back	Adjusts the vertical registration for the back side in duplex mode. If the machine settings are reset to the factory defaults, this value does not change. [-15 to 15 / 0 (Default) / 1 mm/step]
Init Engine EEPROM	<p>This clears all counters except "Full Color" and "Black and White" in the total counter.</p> <p>When you execute "Init Engine EEPROM", the engine EEPROM is initialized.</p> <p>Turn the machine power off/on after you change this setting.</p>	
Model	<p>DFU (Designed for Factory Use)</p> <p>Do not change this setting.</p> <p>Displays only</p> <p>Displays the current model in a dropdown list.</p>	
Brand ID	<p>DFU (Designed for Factory Use)</p> <p>Do not change this setting.</p> <p>00* – 7F</p> <p>Displays the current brand ID number.</p>	
Maintenance ID	<p>DFU (Designed for Factory Use)</p> <p>Do not change this setting.</p> <p>00* – 7F</p> <p>Displays the current maintenance ID number.</p>	



## Service Menu

LSU Adjustment	Input 160 bytes setting.	Character: alphanumeric "0-9", "a-f", "A-F", only valid data can be input. Input length: 160 bytes
Trans. Belt Adjust	When you execute "Trans. Belt Adjust", the transfer belt adjustment is done. This calibrates the motor speed to match the length of the new transfer belt.	
Fuser SC Detect	On/Off*	If On, the engine detects SC559. If Off, the engine does not detect "Fusing SC Reset".
Color Registration	The engine will do color registration and density tuning automatically. The printer will warm up automatically after this setting is changed.	
Reset Transfer Unit	Resets the transfer unit life counter.	
Reset Fuser Unit	Resets the fusing unit life counter.	
Fuser SC Reset	Resets the Fusing related SC.	
Reset 2nd Transfer unit	Resets the 2nd transfer unit (transfer roller) life counter.	
Special Mode	DFU (Designed for Factory Use) Do not change this setting.	
Economy Color Print	Tentative Density	Sets the tentative density of each mode. Text: 100 / 50 / 30 (Default: 100) Image: 100 / 50 / 30 (Default: 50) Graphic: 100 / 50 / 30 (Default: 30)
	Conversion Mode	Sets the conversion mode for the economy color print. No: No conversion is executed. Color Up Mode: Converts into economy color. The image density is decreased. B&W Up Mode: Converts into Economy Black and white.
PM Parts Rep Notice	Sets whether to display the PM parts replacement notice and whether to stop the engine.	
	0	At near end: No Notice / Not Stopped

		At life end: Notice "Replace Now" / Not Stopped
1		At near end: No Notice / Not Stopped
		At life end: No Notice / Not Stopped
2 (default)		At near end: Notice / Not Stopped
		At life end: Notice "Replace Now" / Not Stopped
3		At near end: Notice "Replace Soon" / Not Stopped
		At life end: Notice "Replace Now" / Stopped

Scan Maintenance		
Mono Compression	Sets the monochrome compression type for scanning. MH (Default)/ MR/ MMR	
Registration Adjust	ADF Main Reg.	Adjusts the ADF Scan main-scan registration. [-1.0 to 1.5 / 0 (Default)/ 0.1 mm/step]
	ADF Sub Reg.	Adjusts the ADF Scan sub-scan registration. [-1.0 to 1.5 / 0 (Default)/ 0.1 mm/step]
	Flatbed Main Reg.	Adjusts the Flatbed Scan main-scan registration. [-1.0 to 1.5 / 0 (Default)/ 0.1 mm/step]
	Flatbed Sub Reg.	Adjusts the Flatbed Scan sub-scan registration. [-1.0 to 1.5 / 0 (Default)/ 0.1 mm/step]
Size Adjust	ADF Main Reg.	Adjusts the ADF Scan main-scan magnification. [-0.9 to 0.9 / 0 (Default)/ 0.1 %/step]
	ADF Sub Reg.	Adjusts the ADF Scan sub-scan magnification. [-0.9 to 0.9 / 0 (Default)/ 0.1 %/step]
	Flatbed Main Reg.	Adjusts the Flatbed Scan main-scan magnification. [-0.9 to 0.9 / 0 (Default)/ 0.1 %/step]
	Flatbed Sub Reg.	Adjusts the Flatbed Scan sub-scan magnification. [-0.9 to 0.9 / 0 (Default)/ 0.1 %/step]

Fax Maintenance
-----------------

Modem Settings	RX Level	Sets the reception level. [-43 dBm (Default)/ -33 dBm/ -26 dBm / -16 dBm]
	TX Level	Sets the transmission level. [0 dBm/ -1 dBm/ -2 dBm/ -3 dBm/ -4 dBm / -5 dBm/ -6 dBm/ -7 dBm/ -8 dBm/ -9 dBm / -10 dBm/ -11 dBm/ -12 dBm/ -13 dBm / -14 dBm/ -15 dBm]
	Cable Equalizer	These selectors are used to improve the pass-band characteristics of analogue signals on the telephone line. [0Km (Default)/ 1.8Km/ 3.6Km/ 7.2Km]
Protocol Definition	Training Retries	This sets the number of training retries to be repeated before automatic fallback. [1 Time/ 2 Times (Default)/ 3 Times/ 4 Times]
	Encoding	Sets the compression method for Tx/Rx. [MMR+MR+MH (Default)/ MR+MH/ MH]
Protocol Definition Timer	T0 Timer	Timeout for response from the called station in automatic sending mode [35 Sec/ 45 Sec/ 55 Sec/ 60 Sec(Default)/ 90 Sec/ 140 Sec]
	T1 Timer	Set the time length for the T1 timer. [40 Sec (Default)/ 50 Sec]
	T4 Timer	Set the time length for the T4 timer. [3 Sec (Default/ 4.5 Sec]
RX Settings	Silence Detection	Silence (No tone) detection time (Rx mode : FAX/ TAD Only) After the line is connected via the external telephone, the machine can detect silence (no tone) for the time length specified by this setting. [30 sec (Default)]

	CNG Tone Detection Time	CNG tone detection time ( RX mode : FAX / TEL, FAX / TAD Only) After the line is connected via the external telephone, the machine can detect a CNG signal for the time length specified by this setting. [5 Sec (Default)/ 10 Sec]
	CNG Cycles	Number of CNG cycles to be detected This setting is only effective for FAX/TAD mode. [1.5 Cycle (Default)/ 2.0 Cycle]
	Tone Sound Monitoring	Determines the period when tones from the line are monitored. [No Monitoring/ Up To Phase B (Default)/ All TX Phases]
RX Settings	Stop/Clear key	Pressing the Stop/Clear key can stop the current receiving operation. Received data is lost. [No Functional (Default)/ Functional]
	Off-Hook Level	DFU (Designed for Factory Use) Do not change this setting. [10V (Default)/ 15V/ 20V/ 25V]
	Off-Hook Detection Period	Sets the Off-Hook detection period. 200 ms (default) 800 ms
	Number for Remote Switch	- [0 to 9 / - / 1step]
	Number of time to press	- [1 to 3 / - / 1step]
	Period for TEL to FAX	- [Limitless / 10 sec / 20 sec / 30 sec/ 40 sec]
TX Settings	Redial Interval	Sets the redial interval when Tx fails. [5 Min/ 6 Min]
	Redialings	Sets the number of redials when Tx fails. [2 times/ 3 Times/ 4 Times/ 5 Times]

Overseas Comm Mode Settings	Overseas Comm Mode	This sets the machine to ignore a DIS signal sent from the called station once in a sending operation. [Off (Default)/ Ignore DIS Once]
	Minimum Time Length	If this setting is set to "On", the machine detects the CNG signal after the line is connected. If it is set to "Off", the machine detects the CNG signal as long as the line is connected. [100 Ms/ 200 Ms/ 300 Ms/ 400 Ms (Default)]
Dial Pulse Setting	Dial Pulse Type	This sets the number of pulses that are generated during dialing. <ul style="list-style-type: none"> <li>▪ N: Dialing '0' generates 10 pulses --- Dialing '9' generates 9 pulses.</li> <li>▪ N+1: Dialing '0' generates 1 pulses --- Dialing '9' generates 10 pulses.</li> <li>▪ 10-N: Dialing '0' generates 10 pulses --- Dialing '9' generates 1 pulse.</li> </ul>
Tone Signal Settings	Tone Signal Transmission Time Length	Sets the tone signal transmission time length [100 ms (Default)]
	Minimum Pause in Tone Dialing	Sets the minimum pause during tone dialing [100 ms (Default)/ 150 ms/ 200 ms]
	Attenuator For Pseudo RingBack tone To the Line	Sets the attenuator for pseudo ringback tone to the line [0 to 15 / 10 (Default)/ 1 dB/step]
	DTMF Level	Sets the transmission level of DTMF tones. [-12 dBu / -11 dBu/ -10 dBu/ -8 dBu/ -6 dBu]
	DTMF Delta	Sets the level difference between high band frequency signals and low band frequency signals when sending DTMF tones. [2 dBu/ 3 dBu]

1Dial Tone Detection	Wait Time	The machine starts dialing after the specified interval without detection of a dial tone when Dial tone detection is set to "No detection". [3.5 Sec (Default)/ 7.0 Sec/ 10.5 Sec / 14.0 Sec]
	Timeout Length	This setting sets the time-out length for the 1st dial tone detection. The machine waits for a dial tone for the specified time and disconnects itself from the line when no dial tone is input. [10 Sec (Default)/ 15 Sec/ 20 Sec/ 30 Sec]
BT (Busy Tone) Detection	BT Setting	DFU (Designed for Factory Use) Do not change this setting. [Off/ On] BT: Busy tone
	BT Frequency	DFU (Designed for Factory Use) Do not change this setting. [300-550 Hz/ 300-650 Hz/ 325-525 Hz/ 340-550 Hz/ 350-500 Hz/ 350-550 Hz/ 375-475 Hz/ 380-520 Hz]
	BT Level	DFU (Designed for Factory Use) Do not change this setting. [-35 dB/ -36 dB/ -37 dB/ -38 dB/ -39 dB]
	BT Cadence	DFU (Designed for Factory Use) Do not change this setting. [0.10/ 0.15/ 0.20/ 0.25/ 0.30/ 0.35/ 0.40/ 0.45/ 0.50/ 0.75]
Comm Settings	RTN Rate	The machine checks the actual data reconstruction errors and then transmits an RTN depending on the decoding error rate that is set by this setting (Number of lines containing an error per page / Total number of lines per page). [10%/ 15%]
	V34 Modem	DFU (Designed for Factory Use) Do not change this setting. [Permitted (Default)/ Prohibited]

Service Menu

	V17 Modem	DFU (Designed for Factory Use) Do not change this setting. [Permitted (Default)/ Prohibited]
V34 Settings	Equalizer	These selectors set the equalizer's training level to be applied if training fails due to poor line connection. [Automatic (Default)/ 4 Point/ 16 Point]
	Redialing	Resend when a communication error occurs. [Disabled (Default)/ Not Disabled]
	First TX Speed	Sets the first transmission speed choice, before fallback. [2400 Bps/ 4800 Bps/ 7200 Bps/ 9600 Bps / 12000 Bps/ 14400 Bps/ 16800 Bps/ 19200 Bps/ 21600 Bps/ 24000 Bps/ 26400 Bps/ 28800 Bps/ 31200 Bps/ 33600 Bps (Default)]
	Symbol Rate	This setting limits the transmission speed range in V.34 mode by masking the desired symbol rate(s). [Not Used (Default)/ 3429 Sym/Sec / 3200 Sym/Sec/ 3000 Sym/Sec / 2800 Sym/Sec/ 2400 Sym/Sec]
Internet Fax Function (only for :M204)	Disable/Enable	Decides whether the Internet Fax function is used or not. Default: Enabled
	Reply-To Setting	Sets "Reply-To" in the SMTP authentication. Yes: Sets the e-mail address that is usually set in the "From" field in the "Reply-To" field, and sets the "Administrator e-mail Address" in the "From" field. No: Not set. Default: No
	Prt Rec Txt Mail Header	Selects whether or not to print the header part of E-mail. Default: No

All Document Transfer	<p>If the machine cannot print faxes due to a printer malfunction or for any other reason, transfer the data to another fax machine for printing.</p> <p>This feature is for both TX/RX jobs of fax and Internet Fax, and excludes reports. Below is a list of target data that should be transferred:</p> <ol style="list-style-type: none"><li>1. Fax RX image data (receive/forward)</li><li>2. Fax TX image data (redial)</li><li>3. Internet Fax RX image data (receive/forward)</li><li>4. Internet Fax TX image data (redial)</li><li>5. PC fax jobs (redial)</li></ol> <p>Max. 40 characters (one byte)</p>
-----------------------	---



### 4.1.3 SERVICE MODE (PRINTER MODELS)

#### Menu List

Service Menu		
Toner Limit	Toner Limit Tex	Determines the maximum amount of ink/toner you can use in any area of your text. This is where you are controlling exactly how much ink will be used during printing. [200 to 400 / 250 (Default)/ 10/step] Setting 0: Off
	Toner Limit Gra	Determines the maximum amount of ink/toner you can use in any area of your graphic. This is where you are controlling exactly how much ink will be used during printing. [200 to 400 / 250 (Default)/ 10/step] Setting 0: Off
	Toner Limit Ima	Determines the maximum amount of ink/toner you can use in any area of your image. This is where you are controlling exactly how much ink will be used during printing. [200 to 400 / 250 (Default)/ 10/step] Setting 0: Off

Engine Maintenance	
Model	Displays only Displays the current model in a dropdown list. Do not change this setting (Designed for Factory Use).
Brand	00* – 7F Displays the current brand ID number. Do not change this setting (Designed for Factory Use).

P <sub>N</sub> P Name	NA Model: RICOH/ 'nul' EU Model: RICOH/ NRG/ LANIER ASIA Model: RICOH/ LANIER China Model: RICOH [0x00 to 0x7F / - / -]	
Destination	Sets the destination and updates the engine setting. DOM/ NA (Default)/ EU/ CHN/ TAIWAN/ ASIA / LA	
2nd Transfer	Media Type	Sets the Media type. *Plain paper, Thin Paper, Thick Paper 2, Thick Paper 1, Envelope, Cardstock, Bond Paper, Label Paper, Prepunched, Preprinted, Letterhead, Color Paper, Recycled Paper, Middle Thick
	2nd Front	Adjusts the transfer roller current, based on the default value. [-15 to 15 / 0 (Default) / 1 $\mu$ A/step]
	2nd Back	Adjusts the transfer roller current, based on the default value. [-15 to 15 / 0 (Default) / 1 $\mu$ A/step]
	Fuser Temp.	Adjusts the temperature of the fusing unit, based on the default value. [-30 to 0 / 0 (Default) / 2°C/step]
Registration	Horiz. Tray1	Adjusts the horizontal registration for tray 1. If the machine settings are reset to the factory defaults, this value does not change. [-15 to 15 / 0 (Default) / 1 mm/step]
	Vert.Tray1	Adjusts the vertical registration for tray 1. If the machine settings are reset to the factory defaults, this value does not change. [-15 to 15 / 0 (Default) / 1 mm/step]
	Horiz Bypass Tray	Adjusts the horizontal registration for the bypass tray. If the machine settings are reset to the factory defaults, this value does not change. [-15 to 15 / 0 (Default) / 1 mm/step]

	Vert Bypass Tray	Adjusts the vertical registration for the bypass tray. If the machine settings are reset to the factory defaults, this value does not change. [-15 to 15 / 0 (Default) / 1 mm/step]
	Horiz.Dup Back	Adjusts the horizontal registration for the back side in duplex mode. If the machine settings are reset to the factory defaults, this value does not change. [-15 to 15 / 0 (Default) / 1 mm/step]
	Vert.Dup Back	Adjusts the vertical registration for the back side in duplex mode. If the machine settings are reset to the factory defaults, this value does not change. [-15 to 15 / 0 (Default) / 1 mm/step]
Counter Reset	Resets counters to factory defaults.	
Clear log	Clears the error and the jam counter logs.	
Reset Transfer	Resets the transfer unit life counter.	
Reset Fuser	Resets the fusing unit life counter.	
Reset 2nd	Resets the 2nd transfer unit (transfer roller) life counter.	
Maintenance ID	00* – 7F Displays the current maintenance ID number. Do not change this setting (Designed for Factory Use).	
LSU Adjustment	Input 160 bytes setting.	Character: alphanumeric "0-9", "a-f", "A-F", only valid data can be input. Input length: 160 bytes
Trans. Belt Adj	When you execute "Trans. Belt Adj", the transfer belt adjustment is done. This calibrates the motor speed to match the length of the new transfer belt.	
Fuser SC Detect	On/Off*	If On, the engine detects SC559. If Off, the engine does not detect "Fusing SC Reset".
Fuser SC Reset	Resets the Fusing related SC.	
Color Regist	The engine will do color registration and density tuning automatically. The printer will warm up automatically after this setting is changed.	

Special Mode	DFU (Designed for Factory Use) Do not change this setting.
--------------	---

Economy Color	
Tentative Den	Text: 100 / 50 / 30 (Default: 100) Image: 100 / 50 / 30 (Default: 50) Graphic:100 / 50 / 30 (Default: 30)
Conversion Mode	Sets the conversion mode for the economy color print. No: No conversion is executed. Color Up Mode: Converts into economy color. The image density is decreased. B&W Up Mode: Converts into Economy Black and white.

#### 4.1.4 FAX SERVICE TEST MENU (ONLY FOR MF MODELS)

##### ***Entering the Fax Service Test Menu***

Turn on the machine while pressing the "Facsimile" key.

##### ***Selecting an Item***

To select the item, press the "Up" or "Down" key.

##### ***Going into the Next Level/ Returning to the Previous Level***

- To go into the next level of an item, select an item then press the "OK" key.
- To return to the previous level of an item, press the "Return" key.

##### ***Exiting the Maintenance Mode Menu***

To exit the maintenance mode menu, press the "Clear/Stop" or "Return" key until the "Ready" display appears.

##### ***Menu List***

Fax Test (only for MF models)		
Off-Hook Test	On Hook	Executes the on hook test.
	Off Hook	Executes the off hook test
CED Test		Executes the CED test.
CNG Test	1100 Hz	Executes the CNG test
ANSam		Executes the ANSam test.
Ring Tone Test		Executes the ring tone test.
DTMF Test	Tone [0] to [9]	Executes the DTMF tone 0 to 9 test.
	Tone [*]	Executes the DTMF tone * test.
	Tone [#]	Executes the DTMF tone # test.
	Tone Stop	Executes the Stop DTMF tone test.
Modem Test	[V34] 33600 bps	Generates the [V34] 33600 bps signal.
	[V34] 28800 bps	Generates the [V34] 28800 bps signal.

[V17] 14400 bps	Generates the [V17] 14400 bps signal.
[V17] 12000 bps	Generates the [V17] 12000 bps signal.
[V17] 9600 bps	Generates the [V17] 9600 bps signal.
[V17] 7200 bps	Generates the [V17] 7200 bps signal.
[V29] 9600 bps	Generates the [V29] 9600 bps signal.
[V29] 7200 bps	Generates the [V29] 7200 bps signal.
[V27] 4800 bps	Generates the [V27] 4800 bps signal.
[V27] 2400 bps	Generates the [V27] 2400 bps signal.
[V21] 300 bps	Generates the [V21] 300 bps signal.
Signal Stop	Generates the Stop signal.

## 4.1.5 SIZE MISMATCH DETECTION MENU

### *Entering the Size Mismatch Detection Menu*

Press "OK", "Escape", "User Tools" key in sequence.

Engine maintenance	
Size Mismatch Detection	Specifies whether to detect the paper size mismatch. Yes: The error recovery procedure is performed after the paper size mismatch is detected. No: The error recovery procedure will not be performed regardless of the size mismatch. Default: Yes Machine Reboot: Not required

## 4.2 CONFIGURATION, MAINTENANCE AND TEST PAGE INFORMATION

### 4.2.1 OVERVIEW

The configuration page, maintenance page and test page for these models have information about the machine's status. Print this sheet as shown below. Check the configuration page, maintenance page or test page when doing machine maintenance.

#### ***To Print the Configuration Page/ Test Page/ Maintenance Page (Printer Models)***

1. Turn on the machine.
2. Press the "Menu" key.
3. Press the "▲" or "▼" key to select "List/Test Print", and then press the "OK" key.
4. Press the "▲" or "▼" key to select "Config. Page" or "Test Page" or "Maintenance Pg", and then press the "OK" key.
5. The configuration page or test page or maintenance page is printed.

#### **Note**

- Press "Escape" to return to the previous menu.

#### ***To Print the Configuration Page/ Maintenance Page (MF Models)***

1. Turn on the machine.
2. Press the "User Tools" key.
3. Press the "▲" or "▼" key to select "Print List/Report", and then press the "OK" key.
4. Press the "▲" or "▼" key to select "Configuration Page" or "Maintenance Page", and then press the "OK" key.
5. Press "Yes" in the confirmation screen.
6. The configuration page or maintenance page is printed.

#### **Note**

- Press "Escape" to return to the previous menu.



## 4.2.2 ERROR LOG

The Error Log on the configuration page has the error logs (SC codes) and the following information. However, the following error codes cannot be stored after turning off the machine.

Error Code	Description
Code 3	<ul style="list-style-type: none"> <li>▪ Paper misfeed</li> <li>▪ Paper is not detected in the tray.</li> <li>▪ The loaded paper size does not match the setting.</li> <li>▪ Some unit(s) is not correctly installed.</li> </ul>
Code 4	Print/Data Error
Code 5	A consumable supply has run out
Code 6	Warning; Toner near end, Waste toner bottle near full, TM sensor cleaning, Fusing belt near end or Transfer belt near end
Code 7	Alert; Diagnostic Error

### 4.2.3 COUNTER AND COVERAGE (ONLY FOR PRINTER MODELS)

#### Configuration Page

The configuration page for the printer models has the paper jam, coverage and consumed AIO counters in the bottom line, but these counter names are not printed on the configuration page. These counters give the following information;

Three counters [A]:	Feed jam counter, inner jam counter, duplex jam counter
Four counters [B]:	Recent coverage of K, C, M, Y
Four counters [C]:	Accumulated Coverage of K, C, M, Y
Four counters [D]:	Consumed High Yield AIO counter of K, C, M, Y
Four counters [E]:	Consumed Short Yield AIO counter of K, C, M, Y
Four counters [F]:	High yield AIO Replacement counter of K, C, M, Y
Four counters [G]:	Short yield AIO Replacement counter of K, C, M, Y

System Maintenance Reference

The symbols [H] printed beside the remaining toner counter indicate the type of the AIO.

- S: Short Yield AIO
- H: High Yield AIO

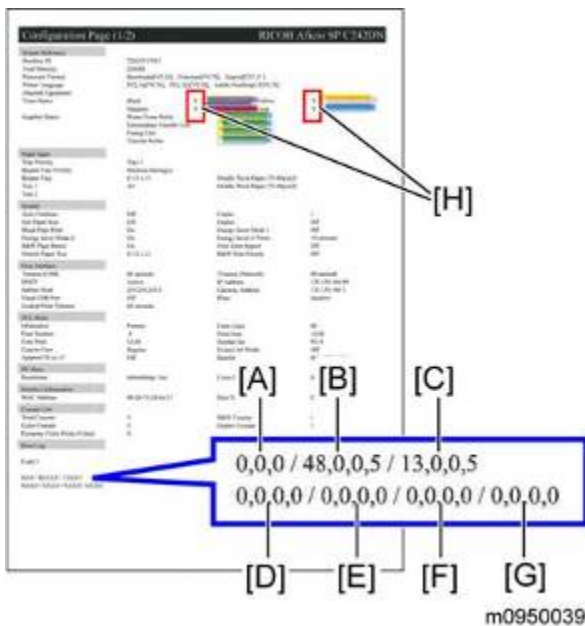

## 4.3 FIRMWARE UPDATING

### CAUTION

- Do not turn off the main power of the machine during the firmware updating. If doing so, the engine board or controller board may be damaged.
- Never disconnect the cable you are using for the updates during the update process.

### 4.3.1 CHECKING THE MACHINE FIRMWARE VERSION

Print the configuration page and take note of the current firmware version (shown under "Firmware Version" on the configuration page).

#### ***To Print the Configuration Page (Printer Models)***

1. Turn the machine on.
2. If the printer driver is not installed on your PC, install the printer driver now.
3. Press the "Menu" key.
4. Press the "▲" or "▼" key to select "List/Test Print", and press the "OK" key.
5. Press the "▲" or "▼" key to select "Config. Page", and then press the "OK" key.

#### ***To Print the Configuration Page (MF Models)***

1. Turn the machine on.
2. If the printer driver is not installed on your PC, install the printer driver now.
3. Press the "User Tools" key.
4. Press the "▲" or "▼" key to select "Print List/Report", and then press the "OK" key.
5. Press the "▲" or "▼" key to select "Configuration Page", and then press the "OK" key.
6. Press "Yes" in the confirmation screen.

### 4.3.2 UPDATING THE CONTROLLER FIRMWARE

Using the following procedure to update the controller firmware, be sure to print the configuration page both before and after the update. Comparing pre- and post-update configuration pages allows you to check whether or not the update was successful.

#### **Procedure**

When updating firmware, always disconnect any cable(s) other than the one being used for the update operation.

1. Download the firmware files to your computer.
  - FwUpdateToolSP.exe (Service mode execute file)
  - Setting.ini (Parameter setting)
  - xxx.brn (Controller Firmware)
2. Make a folder on a local drive of your computer and save the files there.
3. Turn the machine on.
4. Connect the computer and the machine through a network or directly by USB.
5. Double-click the "FWUpdateToolSP.exe" file to execute the updating program.  
A dialog box with cautionary statements appears.
6. Read the cautionary statements carefully, and then click "OK".



m199e2088

The firmware update tool opens.

7. For a USB connection, click "F/W Update (USB)" [A].  
For a network connection, enter the machine's IP address in "Machine IP" [B], and then click "F/W Update (NET)" [C].

## Firmware Updating



The firmware update starts.

### ↓ Note

- When the firmware update starts:
  - For Printer models: The alert LED starts to light up.
  - For MF models: The alert LED starts to light up and machine makes a beep sound.

8. Check the machine's control panel for messages and the update's current percentage of completion.

### ↓ Note

- Do not turn the main power off from this point until the update procedure is completed.

9. Wait until the update completion message appears on the machine's control panel.

### ↓ Note

- When the firmware update is completed:
  - For Printer models: The alert LED starts flashing.
  - For MF models: The alert LED starts flashing and machine makes a beep sound.

10. Click "Close" [A] to close the update tool.

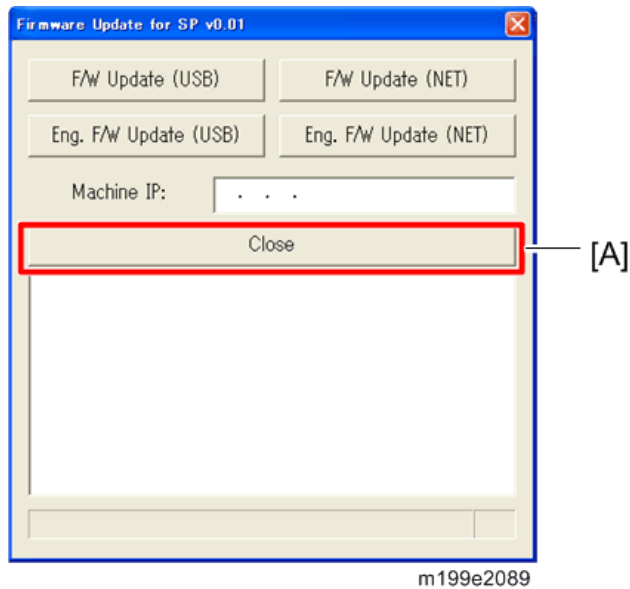

11. Turn off the power of the machine, and then turn it back on.
12. Print a configuration or maintenance page to check the machine's firmware version.

**⚠ CAUTION**

- Do not turn off the machine until the update completion message appears on the machine's control panel. Otherwise, the controller board will be damaged.
- If the update completion message does not appear, the download failed. Try again. You can also switch from an Ethernet connection to a USB connection and see if that works. If you still cannot download the firmware, it may be necessary to change the EGB and/or the controller board.
- If power failed during the download, try again. If you still cannot download the firmware, it may be necessary to change the EGB and/or the controller board.

### 4.3.3 UPDATING THE ENGINE FIRMWARE

When updating firmware, always disconnect any other cable(s) than the one being used for the update operation.

1. Download the firmware files to your computer.
  - FwUpdateToolSP.exe (Service mode execute file)
  - Setting.ini (Parameter setting)
  - yyy.bin (Engine Firmware)
2. Make a folder on a local drive of your computer and save the files there.
3. Turn the machine on.
4. Connect the computer and the machine through a network or directly by USB.
5. Open the top cover.
6. Double-click the "FWUpdateToolSP.exe" file to execute the updating program.  
A dialog box with cautionary statements appears.
7. Read the cautionary statements carefully, and then click "OK".

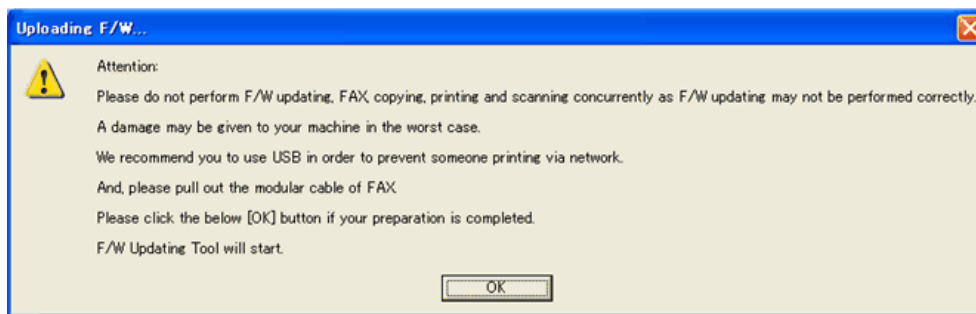

m199e2088

The firmware update tool opens.

8. For a USB connection, click "Eng. F/W Update (USB)" [A].  
For a network connection, enter the machine's IP address in "Machine IP" [B], and then click "Eng. F/W Update (NET)" [C].



The firmware update starts.

**Note**

- When the firmware update starts:  
For Printer models: The alert LED starts to light up.
- For MF models: The alert LED starts to light up and machine makes a beep sound.

**Note**

- Do not turn the main power off from this point until the update procedure is completed.

9. Wait until the update completion message appears on the machine's control panel.

**Note**

- When the firmware update is completed:  
For Printer models: The alert LED starts flashing.
- For MF models: The alert LED starts flashing and machine makes a beep sound.

10. Click "Close" [A] to close the update tool.

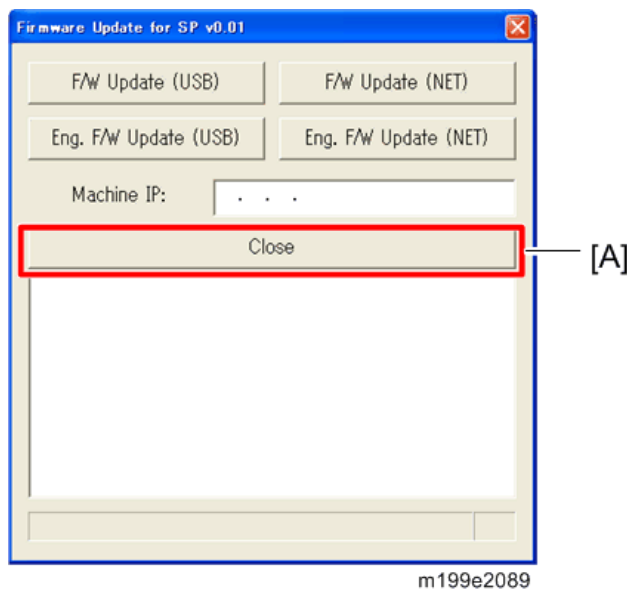



11. Close the top cover.
12. Turn off the power of the machine, and then turn it back on.
13. Print a configuration or maintenance page to check the machine's firmware version.

### **CAUTION**

- Do not turn off the machine until the update completion message appears on the machine's control panel. Otherwise, the controller board will be damaged.
- If the update completion message does not appear, the download failed. Try again. You can also switch from an Ethernet connection to a USB connection and see if that works. If you still cannot download the firmware, it may be necessary to change the EGB and/or the controller board.
- If power failed during the download, try again. If you still cannot download the firmware, it may be necessary to change the EGB and/or the controller board.

### **4.3.4 BOOT LOADER FIRMWARE**

This is also listed on the configuration page, but this firmware is not updated in the field.

# TROUBLESHOOTING

REVISION HISTORY		
Page	Date	Added/Updated/New
		None

## 5. TROUBLESHOOTING

### 5.1 SERVICE CALL CONDITIONS

#### 5.1.1 SUMMARY

This machine issues an SC (Service Call) code if an error occurs on the machine. The error code can be seen on the operation panel.

Make sure that you understand the following points;

1. All SCs are logged.
2. At first, always turn the main switch off and on if an SC code is issued.
3. First, disconnect then reconnect the connectors before you replace the PCBs, if the problem concerns electrical circuit boards.
4. First, check the mechanical load before you replace motors or sensors, if the problem concerns a motor lock.
5. Fusing related SCs: To prevent damage to the machine, the main machine cannot be operated until the fusing related SC has been reset by a service representative.
  - Enter the engine maintenance mode.
  - Press "O.K" in "Fuser SC Reset" with engine maintenance mode, and then turn the main power switch off and on.

#### 5.1.2 ENGINE SC

##### **SC 1xx (Other Error)**

195	Serial Number Error
	The serial number stored in the memory (EGB) is not correct.
	<ul style="list-style-type: none"> <li>▪ EEPROM defective</li> <li>▪ EGB replaced without original EEPROM</li> </ul> <ol style="list-style-type: none"> <li>1. Check the serial number.</li> <li>2. If the stored serial number is incorrect, contact your supervisor.</li> </ol>

**SC 2xx (Laser Optics Error)**

202	Polygon motor error 1: ON timeout
	The polygon mirror motor does not reach the targeted operating speed within 5 sec. after turning on or changing speed.
203	Polygon motor error 2: OFF timeout
	The polygon mirror motor does not leave the READY status within 3 sec. after the polygon motor switched off.
204	Polygon motor error 3: XSCRDY signal error
	The SCRDY_N signal remains HIGH for 200 ms while the LD unit is firing.
	<ul style="list-style-type: none"> <li>▪ Polygon motor/driver board harness loose or disconnected</li> <li>▪ Polygon motor/driver board defective</li> <li>▪ Laser optics unit defective</li> <li>▪ IPU (EGB) defective                             <ol style="list-style-type: none"> <li>1. Replace the interface harness of the laser optics unit.</li> <li>2. Replace the laser optics unit.</li> <li>3. Replace the EGB (Engine Board).</li> </ol> </li> </ul>

220	Laser Synchronizing Detection Error: [K]/[Y]
	The laser synchronizing detection signal for LDB [K]/[Y] is not output after the LDB unit has turned on while the polygon motor is rotating normally.
222	Laser Synchronizing Detection Error: [M]/[C]
	The laser synchronizing detection signal for LDB [M]/[C] is not output after the LDB unit has turned on while the polygon motor is rotating normally.
	<ul style="list-style-type: none"> <li>▪ Disconnected cable from the laser synchronizing detection unit or defective connection</li> <li>▪ Defective laser synchronizing detector</li> <li>▪ Defective LDB</li> <li>▪ Defective EGB                             <ol style="list-style-type: none"> <li>1. Check the connectors.</li> <li>2. Replace the laser optics unit.</li> <li>3. Replace the EGB.</li> </ol> </li> </ul>

240	LD error
	The IPU (EGB) detects a problem at the LD unit.
	<ul style="list-style-type: none"> <li>▪ Worn-out LD</li> <li>▪ Disconnected or broken harness of the LD.</li> </ul> <ol style="list-style-type: none"> <li>1. Replace the laser optics unit.</li> </ol>

### SC 3xx (Charge Error)

300	High voltage power output error
	The measured voltage is not correct when the EGB measures each charge output (charge, development, image transfer belt unit, and transfer unit).
	<ul style="list-style-type: none"> <li>▪ Disconnected or defective high voltage harness</li> <li>▪ Defective high voltage power supply</li> <li>▪ Defective EGB</li> </ul> <ol style="list-style-type: none"> <li>1. Check or replace the harnesses.</li> <li>2. Replace the high voltage power supply board</li> <li>3. Replace the EGB.</li> </ol>

396	Black drum motor error
	The LOCK signal error is detected when the EGB monitors the black drum motor state. (This monitoring is done immediately after power-on, when the motor starts rotating, and immediately after the motor stops.)
	<ul style="list-style-type: none"> <li>▪ Disconnected or defective motor harness.</li> <li>▪ Motor slips due to excessive load</li> </ul> <ol style="list-style-type: none"> <li>1. Check the harness from the black drum motor. Replace it if necessary.</li> </ol>
397	Color drum motor error
	The LOCK signal error is detected when the EGB monitors the color drum motor state. (This monitoring is done immediately after power-on, when the motor starts rotating, and immediately after the motor stops.)

	<ul style="list-style-type: none"> <li>▪ Disconnected or defective motor harness.</li> <li>▪ Motor slips due to excessive load             <ol style="list-style-type: none"> <li>1. Check the harness from the color drum motor. Replace it if necessary.</li> </ol> </li> </ul>
--	---

**SC 4xx (Image Transfer and Transfer Error)**

400	TM sensor error
	The CPU detected a low voltage of the positive reflection output under the threshold in the TM sensor.
	<ul style="list-style-type: none"> <li>▪ TM sensors are dirty.</li> <li>▪ A solid print out due to an electrostatic charging error</li> <li>▪ The TM sensor is defective.</li> </ul> <ol style="list-style-type: none"> <li>1. Clean the TM sensors.</li> <li>2. Replace the TM sensors.</li> <li>3. Check the image transfer unit.</li> <li>4. Turn the power Off and On.</li> </ol>
445	ITB (Image Transfer Belt) Unit: Home Position Error
	The ITB contact sensor does not detect the home position of the ITB for 5 seconds after the ITB unit initialization has been done.
	ITB (Image Transfer Belt) Unit: Contact Position Error
	The ITB contact sensor does not detect the contact position of the ITB for 5 seconds after the ITB unit has moved to the contact position.
	ITB (Image Transfer Belt) Unit: No-contact Position Error
	The ITB contact sensor does not detect the home position of the ITB for 5 seconds after the ITB unit has moved to no-contact position.
	<ul style="list-style-type: none"> <li>▪ Defective ITB contact motor</li> <li>▪ Defective ITB contact sensor</li> <li>▪ Defective ITB unit             <ol style="list-style-type: none"> <li>1. Replace the ITB contact motor.</li> <li>2. Replace the ITB contact sensor.</li> <li>3. Replace the ITB unit.</li> </ol> </li> </ul>

480	Agitator Motor Error
	The agitator motor error is detected twice for 10 msec during the initialization at power-on or after the cover is closed.
	<ul style="list-style-type: none"> <li>▪ Disconnected or defective harness</li> <li>▪ Defective agitator motor             <ol style="list-style-type: none"> <li>1. Check or replace the harness.</li> <li>2. Replace the agitator motor.</li> </ol> </li> </ul>

490	ITB (Image Transfer Belt) Unit Set Error
	The TM sensor does not detect the reflection from the ITB.
	<ul style="list-style-type: none"> <li>▪ No ITB unit in the machine</li> <li>▪ Dirty TM sensor             <ol style="list-style-type: none"> <li>1. Check the installation of the ITB unit.</li> <li>2. Clean the TM sensor.</li> </ol> </li> </ul>

### SC 5xx (Motor and Fusing Error)

500	Transport/Fusing Motor Error
	The LOCK signal error is detected when the EGB monitors the transport/fusing motor state. (This monitoring is done immediately after power-on, when the motor starts rotating, and immediately after the motor stops.)
	<ul style="list-style-type: none"> <li>▪ Disconnected or defective motor harness.</li> <li>▪ Motor slips due to excessive load             <ol style="list-style-type: none"> <li>1. Check the harness from the transport/fusing motor. Replace it if necessary.</li> </ol> </li> </ul>

530	LSU Fan Motor Error
	A LOCK signal is not detected for more than ten seconds while the motor START signal is on and if this error occurs twice consecutively, this SC is issued.

## Service Call Conditions

	<ul style="list-style-type: none"> <li>▪ Disconnected or defective motor harness.</li> <li>▪ Defective LSU fan motor             <ol style="list-style-type: none"> <li>1. Check or replace the motor harness.</li> <li>2. Replace the LSU fan motor.</li> </ol> </li> </ul>
--	--

	Fusing Fan Motor Error
	A LOCK signal is not detected for more than ten seconds while the motor START signal is on and if this error occurs twice consecutively, this SC is issued.
531	<ul style="list-style-type: none"> <li>▪ Disconnected or defective motor harness.</li> <li>▪ Defective LSU fan motor             <ol style="list-style-type: none"> <li>1. Check or replace the motor harness.</li> <li>2. Replace the fusing fan motor.</li> </ol> </li> </ul>

	Thermistor Error
	The thermistor output is less than 0°C for 7 seconds.
541	<ul style="list-style-type: none"> <li>▪ Disconnected thermistor</li> <li>▪ Defective harness connection             <ol style="list-style-type: none"> <li>1. Check the harness connection of the thermistor.</li> <li>2. Replace the fusing unit.</li> </ol> </li> </ul> <p> <b>Important</b></p> <ul style="list-style-type: none"> <li>▪ Execute "Engine Maintenance Menu" to recover the machine after completing the recovery procedure. Otherwise, the machine continues to issue this SC code and cannot be operated.</li> </ul>

	Print Ready Temperature Error
542	<ul style="list-style-type: none"> <li>▪ The heating roller temperature increase during a set time is not correct.</li> <li>▪ The fusing temperature does not reach the print ready temperature within a set time after the fusing lamp has turned on.</li> </ul>



	<ul style="list-style-type: none"> <li>▪ Defective thermistor</li> <li>▪ Incorrect power supply input at the main power socket</li> <li>▪ Defective fusing lamp                             <ol style="list-style-type: none"> <li>1. Check the voltage of the wall outlet.</li> <li>2. Replace the fusing unit</li> <li>3. Replace the fusing lamp.</li> </ol> </li> </ul> <p><b>★ Important</b></p> <ul style="list-style-type: none"> <li>▪ Execute "Engine Maintenance Menu" to recover the machine after completing the recovery procedure. Otherwise, the machine continues to issue this SC code and cannot be operated.</li> </ul>
--	--

543	High Temperature Detection Error
	<p>This SC is issued if one of following conditions occurs:</p> <ul style="list-style-type: none"> <li>▪ The thermistor (center) detects 255°C or thermistor (end) detects 245°C.</li> <li>▪ The thermistor (center) detects a 3°C increment or more for five seconds at 220°C or more or the thermistor (end) detects a 4°C increment or more for five seconds at 210°C or more.</li> </ul>
	<ul style="list-style-type: none"> <li>▪ Defective I/O control (EGB)</li> <li>▪ Defective EGB                             <ol style="list-style-type: none"> <li>1. Replace the EGB</li> </ol> </li> </ul> <p><b>★ Important</b></p> <ul style="list-style-type: none"> <li>▪ Execute "Engine Maintenance Menu" to recover the machine after completing the recovery procedure. Otherwise, the machine continues to issue this SC code and cannot be operated.</li> </ul>

545	Heating Lamp Full-Power Error
	<p>The fusing lamp is fully-powered for a certain time while the fusing unit stays in the stand-by mode and is not rotating.</p>

	<ul style="list-style-type: none"> <li>▪ Deformed thermistor</li> <li>▪ Thermistor not in the correct position</li> <li>▪ Defective fusing lamp                             <ol style="list-style-type: none"> <li>1. Replace the fusing unit.</li> <li>2. Replace the fusing lamp.</li> </ol> </li> </ul> <p><b>★ Important</b></p> <ul style="list-style-type: none"> <li>▪ Execute "Engine Maintenance Menu" to recover the machine after completing the recovery procedure. Otherwise, the machine continues to issue this SC code and cannot be operated.</li> </ul>
--	---

	Zero Cross Error
	The zero cross signal is not detected for three seconds even though the fusing lamp relay is on after turning on the main power or closing the front door.
547	<ul style="list-style-type: none"> <li>▪ Defective fusing lamp relay                             <ol style="list-style-type: none"> <li>1. Turn the main power switch off and on.</li> </ol> </li> </ul> <p><b>★ Important</b></p> <ul style="list-style-type: none"> <li>▪ Execute "Engine Maintenance Menu" to recover the machine after completing the recovery procedure. Otherwise, the machine continues to issue this SC code and cannot be operated. The power should be turned off and on after the recovery procedure.</li> </ul>

	Low Temperature Error
	The center thermistor detects 100°C or less for 4 seconds.
548	<ul style="list-style-type: none"> <li>▪ Defective fusing lamp</li> <li>▪ Defective thermistor                             <ol style="list-style-type: none"> <li>1. Replace the fusing unit.</li> <li>2. Replace the fusing lamp.</li> </ol> </li> </ul> <p><b>★ Important</b></p> <ul style="list-style-type: none"> <li>▪ Execute "Engine Maintenance Menu" to recover the machine after completing the recovery procedure. Otherwise, the machine continues to issue this SC code and cannot be operated.</li> </ul>

557	Zero Cross Frequency Error
	The detection error occurs ten times consecutively in ten zero cross signal detections. This error is defined when the detected zero cross signal is 17 or less/27 or more for 0.2 seconds.
	<ul style="list-style-type: none"> <li>▪ Defective fusing lamp relay</li> <li>▪ Unstable input power source             <ol style="list-style-type: none"> <li>1. Check the power supply source.</li> <li>2. Replace the fusing unit.</li> <li>3. Turn the main power switch off and on.</li> </ol> </li> </ul> <p><b>★ Important</b></p> <ul style="list-style-type: none"> <li>▪ Execute "Engine Maintenance Menu" to recover the machine after completing the recovery procedure. Otherwise, the machine continues to issue this SC code and cannot be operated. The power should be turned off and on after the recovery procedure.</li> </ul>

559	Consecutive Fusing Jam
	<p>The paper jam counter for the fusing unit reaches 3. The paper jam counter is cleared if the paper is fed correctly.</p> <p>This SC is activated only when this function is enabled with "Engine Maintenance" (default "OFF").</p>
	<ul style="list-style-type: none"> <li>▪ Defective fusing unit</li> <li>▪ Defective fusing control             <ol style="list-style-type: none"> <li>1. Clear this SC to send a command after a jam removal.</li> <li>2. Turn off this function after a jam removal.</li> </ol> </li> </ul> <p><b>★ Important</b></p> <ul style="list-style-type: none"> <li>▪ Execute "Engine Maintenance Menu" to recover the machine after completing the recovery procedure. Otherwise, the machine continues to issue this SC code and cannot be operated.</li> </ul>

**SC 6xx (Communication and Other Error)**

669	EEPROM Error
	An unexpected value exists in the initialization flag of the EEPROM
	<ul style="list-style-type: none"> <li>▪ EEPROM not initialized</li> <li>▪ Defective EEPROM             <ol style="list-style-type: none"> <li>1. Initialize the EEPROM.</li> <li>2. Replace the EEPROM.</li> <li>3. Replace the EGB.</li> </ol> </li> </ul>

690	GAVD Communication Error
	The ID of the GAVD is not identified during initialization.
	The chip ID of the GAVD cannot be detected by the machine at power-on.
	<ul style="list-style-type: none"> <li>▪ Defective EGB             <ol style="list-style-type: none"> <li>1. Replace the EGB.</li> </ol> </li> </ul>

### 5.1.3 CONTROLLER SC

#### SC8xx

819	Service Cycle Power
	<ul style="list-style-type: none"> <li>▪ Incorrect combination of EGB and controller board.</li> <li>▪ An unexpected error occurs in the EEPROM on the controller board.</li> </ul>
	<ul style="list-style-type: none"> <li>▪ Controller board defective               <ol style="list-style-type: none"> <li>1. Install the correct EGB and controller boards for this machine.</li> <li>2. Replace the controller board</li> </ol> </li> </ul>
823	USB/ Network Device Error
	An interface error in the USB connection or NIB connection occurs.
	<ul style="list-style-type: none"> <li>▪ Controller board defective               <ol style="list-style-type: none"> <li>1. Replace the controller board.</li> </ol> </li> </ul>
824	EEPROM Error
	An EEPROM check error at power-on occurs.
	<ul style="list-style-type: none"> <li>▪ Controller board defective               <ol style="list-style-type: none"> <li>1. Replace the controller board.</li> </ol> </li> </ul>
827	On-Board Memory Check Error
	An on-board memory check error at power-on occurs.
	<ul style="list-style-type: none"> <li>▪ Controller board defective               <ol style="list-style-type: none"> <li>1. Replace the controller board.</li> </ol> </li> </ul>
828	ROM Checksum Error
	A ROM checksum error at power-on occurs.
	<ol style="list-style-type: none"> <li>1. Replace the controller board.</li> </ol>

## 5.2 ERROR CODES

### 5.2.1 OVERVIEW

The error codes will be displayed on the LCD if the machine has a problem. These can be recovered by a customer.

### 5.2.2 ERROR CODES LIST

000	Cover Open
	The front or top cover is open.
	<ol style="list-style-type: none"> <li>1. Close the front or top cover.</li> <li>2. Replace the interlock switches or actuator mechanism.</li> </ol>

010	AIO Set Error (Black)
011	AIO Set Error (Magenta)
012	AIO Set Error (Cyan)
013	AIO Set Error (Yellow)
	<ul style="list-style-type: none"> <li>▪ AIO not set</li> <li>▪ Defective connection of the ID chip terminal on the AIO</li> </ul>
	<ol style="list-style-type: none"> <li>1. Install the AIO (black, magenta, cyan or yellow).</li> <li>2. Reinstall or replace the AIO (black, magenta, cyan or yellow).</li> </ol>

014	Waste Toner Bottle Set Error
	<ul style="list-style-type: none"> <li>▪ Waste toner bottle not set</li> <li>▪ Disconnected or defective harness of the waste toner bottle set sensor</li> <li>▪ Defective waste toner bottle set sensor</li> </ul>
	<ol style="list-style-type: none"> <li>1. Install the waste toner bottle.</li> <li>2. Check or replace the harness of the waste toner bottle set sensor.</li> <li>3. Replace the waste toner bottle set sensor.</li> </ol>

030	Tray/Paper Selection Error
	<ul style="list-style-type: none"> <li>▪ No paper in the tray or tray not set in the machine</li> <li>▪ Paper size requested by the job does not match the paper in the tray</li> </ul>
	<ol style="list-style-type: none"> <li>1. Install the tray or put the correct size paper in the tray.</li> <li>2. Check the paper setting in the user menu mode.</li> </ol>

031	Paper Selection Error: Feed and Exit
	<ul style="list-style-type: none"> <li>▪ Paper size requested by the job does not match the paper in the tray</li> <li>▪ Selection error for the paper feed and paper exit location in duplex mode</li> </ul>
	Check the paper feed and exit location in the user menu mode.

050	Jam Error: No Feed from Tray 1
	<ul style="list-style-type: none"> <li>▪ Paper slipped</li> </ul>
	Remove the paper jam at tray 1.

052	Jam Error: No Feed from Optional Tray
	<ul style="list-style-type: none"> <li>▪ Paper slipped</li> </ul>
	Remove the paper jam at the optional tray (Tray 2).

055	Inner Jam Error: Registration/ Paper Exit
	A sheet of paper stays at the registration sensor or paper exit sensor.
	<ul style="list-style-type: none"> <li>▪ Paper slipped</li> <li>▪ Paper double feed</li> </ul>
Remove the paper jam at the registration sensor or paper exit sensor.	

Error Codes

056	Paper Exit Jam Error: Paper Exit/ Fusing Unit
	A sheet of paper stays at the paper exit sensor or winds around the rollers in the fusing unit. <ul style="list-style-type: none"> <li>▪ Paper slipped</li> <li>▪ A sheet of paper is wound around the rollers in the fusing unit</li> </ul>
	Remove the paper jam at the paper exit sensor or in the fusing unit.

070	Printing Error: No Paper
	<ul style="list-style-type: none"> <li>▪ No paper in the tray</li> </ul>
	Put paper in the tray.

080	Toner Near End: Black AIO
081	Toner End: Black AIO
	<ul style="list-style-type: none"> <li>▪ Black toner near-end or end</li> </ul>
	Replace the black AIO.

082	Toner Near End: Magenta AIO
083	Toner End: Magenta AIO
	<ul style="list-style-type: none"> <li>▪ Magenta toner near-end or end</li> </ul>
	Replace the magenta AIO.

084	Toner Near End: Cyan AIO
085	Toner End: Cyan AIO
	<ul style="list-style-type: none"> <li>▪ Cyan toner near-end or end</li> </ul>
	Replace the Cyan AIO.



086	Toner Near End: Yellow AIO
087	Toner End: Yellow AIO
	<ul style="list-style-type: none"> <li>▪ Yellow toner near-end or end</li> </ul>
	Replace the yellow AIO.

088	Waste Toner Bottle: Near Full
089	Waste Toner Bottle: Full
	<ul style="list-style-type: none"> <li>▪ Waste toner bottle near-full or full</li> </ul>
	Replace the waste toner bottle.

999	Color Registration (MUSIC) Error
	<ul style="list-style-type: none"> <li>▪ Color registration (MUSIC) failure</li> </ul>
	This error is not displayed even if this error occurs. It is just logged. This error is automatically recovered after the color registration (MUSIC) has been done successfully.

## 5.3 FAX ERROR CODE DEFINITION (ONLY FOR MF MODELS)

This error code definition is for dial errors, TX communication errors, and RX communication errors.

The Error Code is printed on the TX Report/Activity Report/G3 Protocol dump list.

### 5.3.1 BASIC ERROR CODE STRUCTURE

Error codes consist of six hexadecimal digits (0–5).

***Digit 5 (far left): TX or RX***

TX:	1xxxxx
RX:	2xxxxx
Internet Fax TX:	3xxxxx
Internet Fax RX:	4xxxxx

***Digit 4: Coding (MH/MR/MMR/JBIG)***

MH:	x1xxxx
MR:	x2xxxx
MMR:	x3xxxx
JBIG:	x4xxxx

**Digit 3: Modem mode**

V27ter nonECM	xx1xxx
V29 nonECM	xx2xxx
V17 nonECM	xx3xxx
V33 nonECM	xx4xxx
V34	xx5xxx
V27ter ECM	xx9xxx
V29 ECM	xxaxxx
V17 ECM	xxbxxx
V33 ECM	xxcxxx

***Digit 2: Modem speed***

2400	xxx1xx
4800	xxx2xx
7200	xxx3xx
9600	xxx4xx
12000	xxx5xx
14400	xxx6xx
16800	xxx7xx
19200	xxx8xx
21600	xxx9xx
24000	xxxaxx
26400	xxxbxx
28800	xxxcxx
31200	xxxdxx
33600	xxxexx

Digits 1-0 are assigned to indicate detailed error descriptions.

### 5.3.2 ERROR CODE TABLE

Error Type	Error Description	Error Code
General	Normal (No Error)	0
	STOP	xxxx01
	Unknown Error	xxxxFF
	RX T1 Time Out	Not logged in activity report
Local Mechanical error	Scanner Error during TX	1xxx11
	Memory Full during RX	2xxx14
	Authorized Reception = Enable, Since received TSI was not match, reception was refused.	xxxx06
Dial failure	Connection Fail	xxxx21
	Dial Fail	xxxx22
	Redial All Failed	xxxx23
Comm. Error	TX T1 Time Out	xxxx31
	V8 negotiation Fail	xxxx32
	Retry Out	xxxx40
	Too many FTT	xxxx41
	Too many CRP	xxxx42
	T2 Time Out	xxxx43
	DCN received	xxxx44
	Command Rec Error	xxxx45
	Resp Rec Error	xxxx46
	Invalid Command/Response RX	xxxx47
	Remoter No RX capability	xxxx48

Fax Error Code Definition (only for MF Models)

Error Type	Error Description	Error Code
	T1 time out after EOM	xxxx49
	T2 Time Out	xxxx50
	Image Data not ready	xxxx51
	Phase-C Time Out	xxxx52
	JBIG Buffer Full	xxxx53
	Retry Out	xxxx60
	T2 Time Out	xxxx61
	DCN received	xxxx62
	Too many CRP	xxxx63
	Too many PPR	xxxx64
	RNR time Out	xxxx65
	RTN/PIN Received, EOR/ERR/DCN	xxxx66
	Invalid Command/Response RX	xxxx67
Comm. Error	Command Rec Error	xxxx68
	Resp Rec Error	xxxx69
	Time Out	xxxx70
	Modem hang-up	xxxx80
	V34 abort received	xxxx81
	V34 t1 timeout, control channel error	xxxx82
	V34 t1 timeout, primary channel error	xxxx83
	Data not sent until guard timer expired	xxxx84

***The following information is also included in the User Guide.***

Error Code	Solution
1XXX11	<p>An original has been jammed inside the ADF while sending a fax in Immediate Transmission mode.</p> <ul style="list-style-type: none"> <li>▪ Remove jammed originals, and then place them again.</li> <li>▪ Check the originals are suitable for scanning.</li> </ul>
1XXX21	<p>The line could not be connected correctly.</p> <ul style="list-style-type: none"> <li>▪ Check if the telephone line is properly connected to the machine.</li> <li>▪ Disconnect the telephone line cord from the machine, and connect the cord to a telephone. Check if you can make calls using the telephone. If you cannot make calls this way, contact your telephone company.</li> </ul>
1XXX22 to 1XXX23	<p>Dial fails when trying to send faxes.</p> <ul style="list-style-type: none"> <li>▪ Check if that the fax number you dialed is correct.</li> <li>▪ Check if that the destination is a fax machine.</li> <li>▪ Check if that the line is not busy.</li> <li>▪ You may need to insert a pause between dial digits. Press the [Pause/Redial] key after, for example, the area code.</li> <li>▪ Check if [PSTN / PBX] under [Admin. Tools] has been specified properly for your connection method to the telephone network.</li> </ul>
1XXX32 to 1XXX84	<p>An error occurred while sending a fax.</p> <ul style="list-style-type: none"> <li>▪ Check if the telephone line is properly connected to the machine.</li> <li>▪ Disconnect the telephone line cord from the machine, and connect the cord to a telephone. Check if you can make calls using the telephone. If you cannot make calls this way, contact your telephone company.</li> </ul>

Fax Error Code Definition (only for MF Models)

Error Code	Solution
2XXX14	<p>The machine was not able to print the received fax, or the machine's memory reached its capacity while receiving a fax because the document was too large.</p> <ul style="list-style-type: none"> <li>▪ The paper tray was empty. Load paper in the paper tray.</li> <li>▪ The tray selected in [Select Paper Tray] under [Fax Features] did not contain A4, Letter, or Legal size paper. Load valid size paper in the tray, and configure the paper size settings under [Tray Paper Settings] accordingly.</li> <li>▪ A cover or tray was open. Close the cover or tray.</li> <li>▪ There was a paper jam. Remove the jammed paper.</li> <li>▪ A print cartridge was empty. Replace the print cartridge.</li> <li>▪ The received fax was too large. Ask the sender to re-send the document in parts as several smaller faxes, or to send the fax at a lower resolution.</li> </ul>
2XXX32 to 2XXX84	<p>An error occurred while receiving a fax.</p> <ul style="list-style-type: none"> <li>▪ Check if the telephone line is properly connected to the machine.</li> <li>▪ Disconnect the telephone line cord from the machine, and connect the cord to a telephone. Check if you can make calls using the telephone. If you cannot make calls this way, contact your telephone company.</li> </ul>
3XXX11	<p>Connection to the server failed while sending an Internet Fax.</p> <ul style="list-style-type: none"> <li>▪ Check if the network cable is properly connected to the machine.</li> <li>▪ Check if the network settings such as the IP address, DNS, and SMTP settings have been configured properly (make sure that no double-byte character is used).</li> </ul>
3XXX12	<p>E-mail transmission failed while sending an Internet Fax.</p> <ul style="list-style-type: none"> <li>▪ There was an error in the header of the e-mail. Check if the network settings such as the IP address, DNS, and SMTP settings have been configured properly (make sure that no double-byte character is used).</li> </ul>



Error Code	Solution
3XXX13	<p>E-mail transmission failed while sending an Internet Fax.</p> <ul style="list-style-type: none"> <li>▪ There was an error in the part header of the e-mail. Check if the network settings such as the IP address, DNS, and SMTP settings have been configured properly (make sure that no double-byte character is used).</li> </ul>
3XXX14	<p>E-mail transmission failed while sending an Internet Fax.</p> <ul style="list-style-type: none"> <li>▪ There was an error in the converted TIFF file. Check if the network settings such as the IP address, DNS, and SMTP settings have been configured properly (make sure that no double-byte character is used).</li> </ul>
3XXX33	<p>The machine memory reached capacity while sending an Internet Fax.</p> <ul style="list-style-type: none"> <li>▪ The fax was too large. Resend the document in parts as several smaller faxes, or send the fax at a lower resolution.</li> </ul>
4XXX21	<p>Connection to the server failed while receiving an Internet Fax.</p> <ul style="list-style-type: none"> <li>▪ Check if the network cable is properly connected to the machine.</li> <li>▪ Check if the network settings such as the IP address, DNS, and POP3 settings have been configured properly (make sure that no double-byte character is used).</li> </ul>
4XXX22	<p>E-mail reception failed while receiving an Internet Fax.</p> <ul style="list-style-type: none"> <li>▪ LIST command to the POP3 server failed. Ask the sender to check the e-mail settings.</li> </ul>
4XXX23	<p>E-mail reception failed while receiving an Internet Fax.</p> <ul style="list-style-type: none"> <li>▪ There was an error in the header of the e-mail. Ask the sender to check the e-mail settings.</li> </ul>
4XXX24	<p>E-mail reception failed while receiving an Internet Fax.</p> <ul style="list-style-type: none"> <li>▪ There was an error in the part header of the e-mail. Ask the sender to check the e-mail settings.</li> <li>▪ The e-mail had an invalid Content-Type, or an unsupported type of file (such as PDF or JPEG) was received. Ask the sender to check the file type.</li> </ul>

Fax Error Code Definition (only for MF Models)

Error Code	Solution
4XXX25	<p>E-mail reception failed while receiving an Internet Fax.</p> <ul style="list-style-type: none"> <li>▪ There was an error in the text part of the part body of the e-mail. Ask the sender to check the e-mail settings.</li> </ul>
4XXX26	<p>E-mail reception failed while receiving an Internet Fax.</p> <ul style="list-style-type: none"> <li>▪ There was an error in the received TIFF file (which resulted from a condition not indicated by the error codes 4XXX43 to 4XXX45). Ask the sender to check the TIFF file.</li> </ul>
4XXX42	<p>E-mail reception failed while receiving an Internet Fax.</p> <ul style="list-style-type: none"> <li>▪ There was an error in the part header of the e-mail. Ask the sender to check the e-mail settings.</li> </ul>
4XXX43	<p>A TIFF file could not be received via Internet Fax properly.</p> <ul style="list-style-type: none"> <li>▪ The compression method of the received TIFF file was other than MH/MR/MMR. Ask the sender to check the TIFF file.</li> </ul>
4XXX44	<p>A TIFF file could not be received via Internet Fax properly.</p> <ul style="list-style-type: none"> <li>▪ The resolution of the TIFF file was not supported, or the width of the TIFF file was that of A3 or B4 paper. Ask the sender to check the TIFF file.</li> </ul>
4XXX45	<p>A TIFF file could not be received via Internet Fax properly.</p> <ul style="list-style-type: none"> <li>▪ The format of the TIFF file was other than TIFF-S/F. Ask the sender to check the TIFF file.</li> </ul>
4XXX46	<p>The machine memory reached its capacity while receiving an Internet Fax.</p> <ul style="list-style-type: none"> <li>▪ The fax was too large. Ask the sender to resend the document in parts as several smaller faxes, or send at a lower resolution.</li> </ul>

## 5.4 FAX ERROR CLEAR PRINCIPLE (ONLY FOR MF MODELS)

### 5.4.1 RX

1. When the RX communication Error occurs, the display shows "RX Comm Error".
2. During the display shows "RX Comm Error", any job can be accepted same as the normal status.
3. The "RX Comm Error" to be cleared by receiving any jobs (Fax, Copy, Print, Scan) or pressing any button.

### 5.4.2 TX

1. When the TX communication Error occurs, the display shows the "TX Comm Error".
2. If the auto redial is on, This machine (M203/M204) retry the TX, This machine (M203/M204) doesn't show the error message during the retry.
  - If the retry finish successfully, then return to the normal status.
  - If the retry fail as the number set by user, the message remains as "TX Comm Error".
  - If the auto redial is off, the message is remain.
3. During the display shows "TX Comm Error", any job can be accepted same as the normal status.
4. The "TX Comm Error" to be cleared by receiving any jobs (Fax, Copy, Print, Scan) or pressing any button.

## 5.5 IMAGE PROBLEMS

### 5.5.1 OVERVIEW

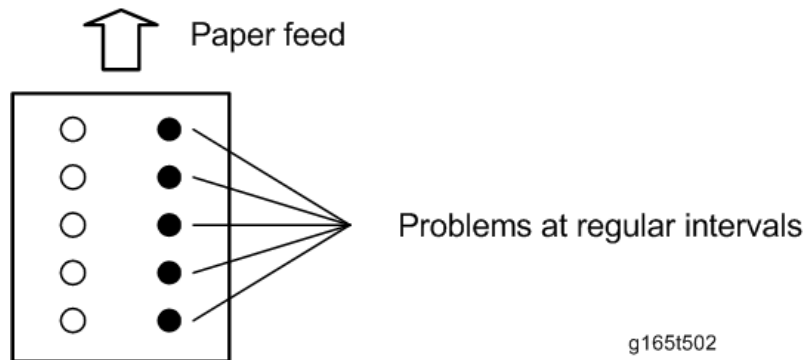

Image problems may appear at regular intervals that depend on the circumference of certain components. The following diagram shows the possible symptoms (black or white dots at regular intervals).

- Abnormal image at 23.5 mm intervals: Paper feed roller.
- Abnormal image at 59 mm intervals: Paper transfer roller
- Abnormal image at 25 mm intervals: Image transfer belt unit (Transfer roller)
- Abnormal image at 30 mm intervals: Charge roller.
- Abnormal image at 38 mm intervals: Registration roller
- Colored spots at 27 mm intervals: AIO cartridge (Development roller)
- Abnormal image at 61 mm intervals: Image transfer belt unit (Drive roller)
- Colored spots at 76 mm intervals: AIO cartridge (OPC drum)
- Abnormal image at 95 mm intervals: Fusing unit (Pressure roller)
- Abnormal image at 76 mm intervals: Fusing unit (Heat roller)

## 5.5.2 IMAGE PROBLEM

Print out a “maintenance page” (all K, C, M, or Y), which will clarify if the cause is a problem with one of the AIOs, Image transfer belt, image transfer roller, or the fusing unit (page 4-21 "Configuration, Maintenance and Test Page Information").

- Occurs with 1-3 colors: AIO unit(s) failure
- Occurs with all four colors: Image transfer belt, transfer roller or fusing unit failure

# ENVIRONMENTAL CONSERVATION

REVISION HISTORY		
Page	Date	Added/Updated/New
		None

## 6. ENVIRONMENTAL CONSERVATION

### 6.1 ENERGY SAVING

#### 6.1.1 ENERGY SAVER MODES

Customers should use energy saver modes properly, to save energy and protect the environment.

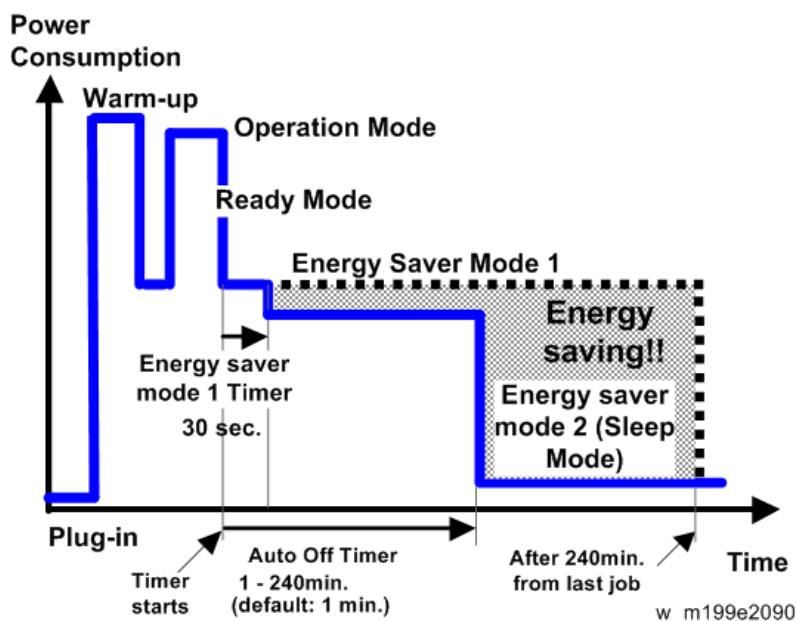

Energy Saver Modes	Description
Energy Saver Mode 1	Lower the fusing temperature.
Energy Saver Mode 2 (Sleep Mode)	No power is supplied to the printing engine, and almost none to the controller.

When the machine is not being used, the machine enters energy saver mode to reduce the power consumption by lowering the fusing temperature.

The area shaded gray in this diagram represents the amount of energy that is saved when the timers are at the default settings (1 minute). If the timers are changed, then the energy saved will be different. For example, if the timers are all set to 240 minutes, the gray area will disappear, and no energy is saved before 240 minutes expires.

### ***Timer Settings (Printer Models)***

- The user can set this timer with the menu mode.
- 1. Press [Menu].
- 2. Press [▼] or [▲] to scroll through the menu listing and press [OK] to select.
- 3. [System] → [Energy Saver 2] → [On/Off] > [On]
- 4. [System] → [Energy Saver 2] → [E.Saver2 Timer] → [1] to [240] min (Select the time with [▼] / [▲] keys.)
- 5. Press [Escape] to return to the previous menu.
- The default setting of Sleep mode is 1 minute.

### ***Timer Settings (MF Models)***

- The user can set this timer with the User Tools mode.
- 1. Press [User Tools].
- 2. Press [▼] or [▲] to scroll through the menu listing and press [OK] to select.
- 3. [Admin. Tools] → [Energy Saver Mode] → [EnergySaverMode 2] → [On/Off] → [On]
- 4. [Admin. Tools] → [Energy Saver Mode] → [EnergySaverMode 2] → [1] to [240] min (Input the time with the 10-key)
- 5. Press [Escape] to return to the previous menu.
- The default setting of Sleep mode is 1 minute.

### ***Return to Stand-by Mode***

#### **Energy Saver Mode 2 (Sleep Mode)**

Recovery time

- 30 seconds or less

#### **Energy Saver Mode 1**

Recovery time

- 10 seconds or less



***Recommendation***

We recommend that the default settings should be kept.

- If the customer requests that these settings should be changed, please explain that their energy costs could increase, and that they should consider the effects on the environment of extra energy use.
- If it is necessary to change the settings, please try to make sure that the Auto Off timer is not too long. Try with a shorter setting first, such as 12 minutes, then go to a longer one (such as 15 minutes) if the customer is not satisfied.
- If the timers are all set to the maximum value, the machine will not begin saving energy until 240 minutes has expired after the last job. This means that after the customer has finished using the machine for the day, energy will be consumed that could otherwise be saved.

## 6.2 PAPER SAVE

### 6.2.1 EFFECTIVENESS OF DUPLEX/COMBINE FUNCTION

Duplexing and the combine functions reduce the amount of paper used. This means that less energy overall is used for paper production, which improves the environment.

#### 1. Duplex

Reduce paper volume in half!



d062d102

#### 2. Combine mode

Reduce paper volume in half!



d062d100

### 3. Duplex + Combine

Using both features together can further reduce paper volume by 3/4!

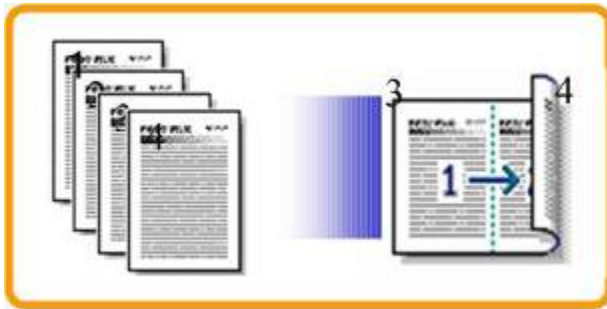

d062d101

To check the paper consumption, look at the total counter and the duplex counter.

The total counter counts all pages printed.

- For one duplex page, the total counter goes up by 2.
- For a duplex job of a three-page original, the total counter goes up by 3.

The duplex counter counts pages that have images on both sides.

- For one duplex page, the duplex counter goes up by 1.
- For a duplex job of a three-page original, the duplex counter will only increase by 1, even though two sheets are used.

**M199/M200/M203/M204**  
**SERVICE MANUAL APPENDICES**

# M199/M200/M203/M204 APPENDICES

## TABLE OF CONTENTS

<b>1. APPENDICES: SPECIFICATIONS .....</b>	<b>1-1</b>
1.1 GENERAL SPECIFICATIONS .....	1-1
1.1.1 PRINTER MODEL (M199/M200) .....	1-1
1.1.2 MF MODEL (M203/M204).....	1-4
Engine .....	1-4
Copier.....	1-7
Scanner.....	1-9
Fax .....	1-10
1.1.3 OPTION.....	1-11
Paper Feed Unit.....	1-11
1.2 CONTROLLER SPECIFICATIONS.....	1-12
1.2.1 PRINTER MODEL (M199/M200) .....	1-12
1.2.2 MF MODEL (M203/M204).....	1-14
1.3 SUPPORTED PAPER SIZES .....	1-16
<b>2. APPENDICES: PREVENTIVE MAINTENANCE.....</b>	<b>2-1</b>
2.1.1 USER REPLACEABLE ITEMS .....	2-1
2.1.2 YIELD ITEMS AND SERVICE MAINTENANCE .....	2-2
2.2 EXCHANGE AND REPLACE PROCEDURE .....	2-3
2.2.1 INSTRUCTION .....	2-3
2.2.2 CLEANING POINTS AFTER MACHINE ARRIVAL AT DEPOT .....	2-4
2.3 FAQs/KNOWLEDGE BASE .....	2-6

# APPENDIX: SPECIFICATIONS

REVISION HISTORY		
Page	Date	Added/Updated/New
		None

# 1. APPENDICES: SPECIFICATIONS

## 1.1 GENERAL SPECIFICATIONS

### 1.1.1 PRINTER MODEL (M199/M200)

Configuration		Desktop	
Print process		Laser electrostatic transfer	
Resolution	Speed Mode		600x600 dpi 1bit (600x600 dpi)
	Standard Mode		600x600 dpi 2 bit (1200 x 600 dpi equivalent)
	Fine Mode		600x600 dpi 4 bit (2400 x 600dpi equivalent)
Printing Speed	General Paper	1-Sided	BW/FC: 20/21ppm (A4/LT SEF)
		2-Sided	BW/FC: 12ppm (A4/LT SEF)
First Print Speed ( Standard Tray )	BW		14 sec. or less(A4/LT SEF)
	FC		14 sec. or less(A4/LT SEF)
Dimensions (W x D x H)	Main Frame		400 x 450 x 320 mm (15.7 × 17.7 ×12.6")
Weight		23.8 kg (52.5lb.) or less *Includes consumables.	
Input capacity (80 g/m <sup>2</sup> )	Standard	Standard Tray	250 sheets
		Bypass tray	1 sheet
	Op. Paper Tray	Paper Feed Unit	500 sheets x 1
	Max		Up to 751 sheets
Output capacity	Standard Tray	Face down	up to 150 sheets (A4/LT or 80g/m <sup>2</sup> , 20lb)

General Specifications

Input Paper Size	Standard Tray		A4, B5, A5, B6, A6, Legal, Letter, HLT, Executive, F, Foolscap, Folio, 16K, Com10, Monarch, C5 Env, C6 Env, DL Env, Custom size: Min. 90 x 148mm (3.54x 5.83"), Max. 216 x 356mm (8.50x 14.0")
	Bypass Tray		A4, B5, A5, B6, A6, Legal, Letter, HLT, Executive, F, Foolscap, Folio, 16K, Com10, Monarch, C5 Env, C6 Env, DL Env, Custom size: Min. 90 x 148mm (3.54"x 5.83"), Max. 216 x 356mm (8.50"x 14.0")
	Op. Paper Tray		A4, Letter
Paper Type	Standard Tray		Plain paper, Recycled paper, Middle thick paper, Thick paper 1/2, Thin paper, Color paper, Letterhead, Preprinted, Prepunched Paper, Labels, Bond, Cardstock, Envelope
	Bypass Tray		Plain paper, Recycled paper, Middle thick paper, Thick paper 1/2, Thin paper, Color paper, Letterhead, Prepunched Paper, Labels, Bond, Cardstock, Envelope
	Op. Paper Feed Unit / Duplex		Plain paper, Recycled paper, Middle thick paper, Thin paper, Thick paper 1, Color paper, Letterhead, Preprinted, Prepunched Paper
Paper Weight	Standard Tray		60-160g/m <sup>2</sup> (16-42lb)
	Bypass tray		60-160g/m <sup>2</sup> (16-42lb)
	Automatic duplex		60-90g/m <sup>2</sup> (16-24lb)
	Op. Paper Tray	Paper Feed Unit	60-105g/m <sup>2</sup> (16-28lb)
Power Requirement	NA version		120-127V/ 60Hz/ less than 11A
	Taiwan version		110V/ 60Hz/ less than 12A



	EU, Asia, China version		220-240V/ 50/60Hz/ less than 6A
Power Consumption	NA	Max.	1300W or less
		Energy Saver	2.7W or less
	EU version	Max.	1300W or less
		Energy Saver	3.8W or less
Warm-up Time			30 sec or less (from power on) (At room temperature 23°C, humidity 50% and supplying the rated power)
Energy Save Mode	Energy Saver mode 1	Power Consumption	80 W or less
		Default Time	30 seconds
	Energy Saver mode 2	Power Consumption	3.8 W or less (EU, Asia version) 2.7 W or less (NA version)
		Default Time	1 minute

**1.1.2 MF MODEL (M203/M204)****Engine**

Configuration		Desktop		
Print process		Laser electrostatic transfer		
Resolution	Speed Mode		600x600 dpi 1bit (600x600 dpi)	
	Standard Mode		600x600 dpi 2 bit (1200 x 600 dpi equivalent)	
	Fine Mode		600x600 dpi 4 bit (2400 x 600dpi equivalent)	
Printing Speed	General Paper	1-Sided	BW/FC: 20/21ppm (A4/LT SEF)	
		2-Sided	BW/FC: 12ppm (A4/LT SEF)	
First Print Speed ( Standard Tray )	BW		14 sec. or less(A4/LT SEF)	
	FC		14 sec. or less(A4/LT SEF)	
Dimensions (W x D x H)	Main Frame		420 x 493 x 460mm (16.5 x 19.4 x 18.7")	
Weight			29.0 kg (64lb.) or less *Includes consumables.	
Input capacity (80 g/m <sup>2</sup> )	Standard	Standard Tray	250 sheets	
		Bypass tray	1 sheet	
	Op. Paper Tray	Paper Feed Unit		500 sheets x 1
		Max		Up to 751 sheets
Output capacity	Standard Tray	Face down	up to 150 sheets (A4/LT or 80g/m <sup>2</sup> , 20lb)	

Input Paper Size	Standard Tray	A4, B5, A5, B6, A6, Legal, Letter, HLT, Executive, F, Foolscap, Folio, 16K, Com10, Monarch, C5 Env, C6 Env, DL Env, Custom size: Min. 90 x 148mm (3.54x 5.83"), Max. 216 x 356mm (8.50x 14.0")
	Bypass Tray	A4, B5, A5, B6, A6, Legal, Letter, HLT, Executive, F, Foolscap, Folio, 16K, Com10, Monarch, C5 Env, C6 Env, DL Env, Custom size: Min. 90 x 148mm (3.54 x 5.83"), Max. 216 x 356mm (8.50 x 14.0")
	Op. Paper Tray	A4, Letter
	Duplex	A4, B5 JIS, Legal , Letter, Executive, 8 1/2 x 13 inches, Folio, 8 inches x 13 inches, 16K
Paper Type	Standard Tray	Plain paper, Recycled paper, Middle thick paper, Thick paper 1/2, Thin paper, Color paper, Letterhead, Preprinted, Prepunched Paper, Labels, Bond, Cardstock, Envelope
	Bypass Tray	Plain paper, Recycled paper, Middle thick paper, Thick paper 1/2, Thin paper, Color paper, Letterhead, Prepunched Paper, Labels, Bond, Cardstock, Envelope
	Op.Paper Feed Unit / Duplex	Plain paper, Recycled paper, Middle thick paper, Thin paper, Thick paper 1, Color paper, Letterhead, Preprinted, Prepunched Paper
Paper Weight	Standard tray	60-160g/m <sup>2</sup> (16-42lb)
	Bypass tray	60-160g/m <sup>2</sup> (16-42lb)
	Automatic duplex	60-90g/m <sup>2</sup> (16-24lb)

## General Specifications

	Op. Paper Tray	Paper Feed Unit	60-105g/m <sup>2</sup> (16-28lb)
ADF	Capacity		35 sheets (80g/m <sup>2</sup> , 20lb)
	Paper size		140 to 216 mm (5 1/2 to 8 1/2 inches) in width, 140 to 356 mm (5 1/2 to 14 inches) in width
	Paper weight		52 to 105 g/m <sup>2</sup> (13.8 to 28.0 lb.)
Power Requirement	NA version		120-127V/ 60Hz/ less than 11A
	Taiwan version		110V/ 60Hz/ less than 12A
	EU, Asia, China version		220-240V/ 50/60Hz/ less than 6A
Power Consumption	NA	Max.	1300W or less
		Energy Saver	3.2W or less
	EU version	Max.	1300W or less
		Energy Saver	3.8W or less
Warm-up Time			30 sec or less (from power on) (At room temperature 23°C, humidity 50% and supplying the rated power)
Energy Save Mode	Energy Saver mode 1	Power Consumption	80 W or less
		Default Time	30 seconds
	Energy Saver mode 2	Power Consumption	3.8 W or less (EU, Asia version) 3.2 W or less (NA version)
		Default Time	1 minute

**Copier**

1st copy speed		Platen/ADF	BW: Less than 20 sec. (A4/LT SEF) FC: Less than 20 sec. (A4/LT SEF)
Maximum original size		Platen	A4 (210 x 297mm) / Letter (215.9 x 279.4mm)
		ADF	A4 (210 x 297mm) / Letter (215.9 x 279.4mm)/ Legal (215.9 x 355.6mm)
Copy Speed	Single Document Multiple Copy	Platen	BW: 20 cpm (A4), 21/21cpm (LT) FC: 20 cpm (A4) , 21/21cpm (LT) *14ppm in Germany and 9ppm in Belgium & Austria
		ADF	BW: 20 cpm (A4), 21/21cpm (LT) FC: 20 cpm (A4) , 21/21cpm (LT) *14ppm in Germany and 9ppm in Belgium & Austria
	Multiple Document Single Copy	ADF	BW: 20cpm (A4/LT, 300x600dpi) FC: 12 cpm (A4/LT, 300x600dpi)
Multiple copy			Up to 99
Resolution (H x V)		Scanning	600 x 600 dpi
		Printing	600 x 600 dpi
Grayscale			256 levels
Reduction / Enlargement		Fix	NA: 50, 65, 78, 93, 129, 155, 200, 400% EU: 50, 71, 82, 93, 122, 141, 200, 400%
		Custom	Book: 25 - 400% in 1% step ARDF: 25 - 200% in 1% step
Image density adjustment			Yes, Manual only: 5 levels

General Specifications

Copy mode (Image quality mode)	Yes (Text / Photo / Text Photo)
Memory copy	Yes
Duplex copy	Yes
Interrupt copy	No
Combine copy	2 in 1, 4 in 1
ID Copy copy	Yes (only 2 in1)
APS/AMS	No
Auto Tray Switch	No
Directional Magnification	No
Directional Size Magnification	No
Photo Mode	Yes
Auto Start	No
User Program	No
Electronic Sorting	Yes
Image Rotation	No
Series Copy	No

**Scanner**

Scanning Device		Contact Image Sensor (CIS)
Scan Mood		Color, B/W, Grayscale
Scanning Resolution		1200 x1200 dpi
Gray scale		256 levels
Scan speed		BW: Less than 5 sec. FC: Less than 10 sec.
Maximum scanning area (horizontal x vertical)	Platen	216 x 297 mm (8.5 x 11.7 inches)
	ADF	216 x 356 mm (8.5 x14 inches)
Gradation	Input	16 bit color processing
	Output	8 bit color processing
Interface		Scanning from the control panel <ul style="list-style-type: none"> <li>▪ Ethernet (10BASE-T, 100BASE-TX) , USB2.0 (Scan to USB)</li> </ul> Scanning from a computer <ul style="list-style-type: none"> <li>▪ Ethernet (10BASE-T, 100BASE-TX), USB 2.0</li> </ul>
Sendable file formats		TIFF, JPEG, PDF

**Fax**

Access line	PSTN/ PBX	
Transmission mode	ITU-T Group 3 (G3)	
Data compression method	MH, MR, MMR, JBIG	
Transfer rate	33.6 kbps to 2400 bps (auto shift down system)	
Resolution	8 x 3.85/ 8 x 7.7 lines/mm 200 x 100/ 200 x 200 dpi	
Scanning Speed	Less than 5 sec. ( Platen/ADF )	
Transmission Speed	G3: Approx.3 seconds (200x100 dpi, ,JBIGmb, ITUT #1 chart TTI off, memory transmission)	
Scan Page per Minute(DF used)	A4/LT SEF	Less than 20 spm (A4/LT SEF) (8 x 3.85)
	A4/LT LEF Image Rotation	LEF not available
Page Memory Size	Std	2MB
	with Optional SAF Memory	No
SAF Memory Size	Std	8*3.85 line/mm (Approx. 100 pages) by ITUT#1 chart
	with Optional SAF Memory	-
Memory capacity	More than 100 sheets (8 dots per mm x 3.85 line per mm)	
Address book	Speed dial <ul style="list-style-type: none"> <li>▪ 200 items</li> </ul> Quick dial <ul style="list-style-type: none"> <li>▪ 20 items</li> </ul> Number of redials for Fax <ul style="list-style-type: none"> <li>▪ 1</li> </ul>	



**1.1.3 OPTION*****Paper Feed Unit***

Paper Tray (500x1)	Paper Size	A4, Letter (8 1/2 × 11 inches)
	Paper Weight	60 to 105 g/m <sup>2</sup> (16 to 28 lb.)
	Paper capacity	500 sheets
	Dimensions (W x D x H)	400 × 450 × 127 mm (15.8 × 17.8 × 5 inches)
	Weight	Less than 4 kg (8.9 lb.)

## 1.2 CONTROLLER SPECIFICATIONS

### 1.2.1 PRINTER MODEL (M199/M200)

Processor		350MHz
Memory	Std.	128MB
Resolution		Speed Mode: 600x600 dpi 1bit (600x600 dpi) Standard Mode: 600x600 dpi 2 bit (1200 x 600 dpi equivalent) Fine Mode: 600x600 dpi 4 bit (2400 x 600dpi equivalent)
Interface	Std.	USB2.0,100Base-TX/10Base-T, IEEE802.11b/g/n
Language	Std.	PCL6/5c, PostScript3, PictBridge
Font		PCL: 80 fonts
Operating Systems		WindowsXP/Vista/7/8, Server2003/2008/2012 (32bit/64bit) and later
		Mac OS 10.64-10.8 and later
Network Protocols		TCP/IP, IPP, Bonjour

Print Resolution		
Engine		Speed Mode: 600x600 dpi 1bit (600x600 dpi) Standard Mode: 600x600 dpi 2 bit (1200 x 600 dpi equivalent) Fine Mode: 600x600 dpi 4 bit (2400 x 600dpi equivalent)
PictBridge		
Controller	PCL5c	
	PCL6	
	PostScript3/PDF	
Drivers	PCL5c	
	PCL6	
	PostScript3	

Language		
Operation Panel (LCD)		1. English, 2. German, 3. French, 4. Italian, 5. Spanish, 6. Dutch, 7. Swedish, 8. Norwegian, 9. Danish, 10. Finnish, 11. Portuguese
Drivers	PCL5c	1. English, 2. German, 3. French, 4. Italian, 5. Spanish, 6. Dutch, 7. Swedish, 8. Norwegian, 9. Danish, 10. Finnish, 11. Portuguese, 12. Czech, 13. Hungarian, 14. Polish, 15. Russian, 16. Turkish, 17. Brazilian Portuguese
	PSL6	
	PostScript3	
Test Page Print	Config. Map	1. English, 2. German, 3. French, 4. Italian, 5. Spanish, 6. Dutch, 7. Swedish, 8. Norwegian, 9. Danish, 10. Finnish, 11. Portuguese, 12. Czech, 13. Hungarian, 14. Polish, 15. Russian, 16. Turkish, 17. Brazilian Portuguese
	The others	1. English

Interface Specification		
Network Interface Board (Standard)	Data Transmission Speed	10Mbps, 100Mbps, 1000Mbps
	Protocol	TCP/IP, IPX/SPX
	Supported OS	WindowsXP/Vista/7/8, Server2003/2008/2012, Mac OS 10.6-10.8 and later
	Distance between devices	100m
USB2.0 Interface (Standard)	Data Transmission Speed	480Mbps (High Speed:USB2.0), 12Mbps (Full Speed)
	Supported OS	WindowsXP/Vista/7/8, Server2003/2008/2012, Mac OS 10.6-10.8 and later

 **Note**

- SPX protocol requires Netware option.

### 1.2.2 MF MODEL (M203/M204)

Processor		400MHz
Memory	Std.	256MB
Resolution		Speed Mode: 600x600 dpi 1bit (600x600 dpi) Standard Mode: 600x600 dpi 2 bit (1200 x 600 dpi equivalent) Fine Mode: 600x600 dpi 4 bit (2400 x 600dpi equivalent)
Interface	Std.	USB2.0,100Base-TX/10Base-T, IEEE802.11b/g/n
Language	Std.	PCL6/5c, PostScript3, PictBridge
Font		PCL/PS: 80 fonts
Operating Systems		WindowsXP/ Vista/ 7/ 8, Server2003/ 2008/ 2012 (32bit/64bit) and later
		Mac OS 10.64-10.8 and later
Network Protocols		TCP/IP, IPP, Bonjour

Print Resolution		
Engine		Speed Mode: 600x600 dpi 1bit (600x600 dpi) Standard Mode: 600x600 dpi 2 bit (1200 x 600 dpi equivalent) Fine Mode: 600x600 dpi 4 bit (2400 x 600dpi equivalent)
PictBridge		
Controller	PCL5c	
	PCL6	
	PostScript3/PDF	
Drivers	PCL5c	
	PCL6	
	PostScript3	

Language		
Operation Panel (LCD)		1. English, 2. German, 3. French, 4. Italian, 5. Spanish, 6. Dutch, 7. Swedish, 8. Norwegian, 9. Danish, 10. Finnish, 11. Portuguese, 12. Czech, 13. Hungarian, 14. Polish, 15. Russian, 16. Turkish, 17. Brazilian Portuguese
Drivers	PCL5c	1. English, 2. German, 3. French, 4. Italian, 5. Spanish, 6. Dutch, 7. Swedish, 8. Norwegian, 9. Danish, 10. Finnish, 11. Portuguese, 12. Czech, 13. Hungarian, 14. Polish, 15. Russian, 16. Turkish, 17. Brazilian Portuguese
	PSL6	
	PostScript3	
Test Page Print	Config. Map	1. English, 2. German, 3. French, 4. Italian, 5. Spanish, 6. Dutch, 7. Swedish, 8. Norwegian, 9. Danish, 10. Finnish, 11. Portuguese, 12. Czech, 13. Hungarian, 14. Polish, 15. Russian, 16. Turkish, 17. Brazilian Portuguese
	The others	1. English

Interface Specification		
Network Interface Board (Standard)	Data Transmission Speed	10Mbps, 100Mbps, 1000Mbps
	Protocol	TCP/IP, IPX/SPX
	Supported OS	WindowsXP/Vista/7/8, Server2003/2008/2012, Mac OS 10.6-10.8 and later
	Distance between devices	100m
USB2.0 Interface (Standard)	Data Transmission Speed	480Mbps (High Speed:USB2.0), 12Mbps (Full Speed)
	Supported OS	WindowsXP/Vista/7/8, Server2003/2008/2012, Mac OS 10.6-10.8 and later

 Note

- SPX protocol requires Netware option.

### 1.3 SUPPORTED PAPER SIZES

A	Supported and the size is molded in the tray. Need to select paper size by operation panel/driver.
B	Supported but size is not molded in the tray. Need to select paper size by operation panel/driver.
C	Need to input paper size by operation panel and driver.
N	Not supported.

Type		SEF/ LEF	Size	Input Tray			Auto. Dup.	
				Standard Tray	Option PFU	Bypass Tray		
Plain Paper	A4	SEF	210x297	A	A	A	Y	
		LEF	297x210	N	N	N	N	
	B5	SEF	182x257	A	N	A	Y	
		LEF	257x182	N	N	N	N	
	A5	SEF	148x210	A	N	A	N	
		LEF	210x148	C	N	C	N	
	B6	SEF	128x182	B	N	B	N	
		LEF	182x128	N	N	N	N	
	A6	SEF	105x148	B	N	B	N	
		LEF	148x105	N	N	N	N	
	Plain Paper	DLT	SEF	11 x 17"	N	N	N	N
		Legal	SEF	8 1/2 x 14"	A	N	A	Y
SEF			14 x 8 1/2"	N	N	N	N	
Letter		SEF	8 1/2 x 11"	A	A	A	Y	

Type		SEF/ LEF	Size	Input Tray			Auto. Dup.	
				Standard Tray	Option PFU	Bypass Tray		
		LEF	11 x 8 1/2"	N	N	N	N	
	Half Letter	SEF	5 1/2 x 8 1/2"	B	N	B	N	
		LEF	8 1/2 x 5 1/2"	N	N	N	N	
	Executive	SEF	7 1/4 x 10 1/2"	A	N	A	Y	
		LEF	10 1/2 x 7 1/4"	N	N	N	N	
	Foolscap	SEF	8 1/2 x 13"	B	N	B	Y	
		LEF	13 x 8 1/2"	N	N	N	N	
	Folio	SEF	8 1/4 x 13"	B	N	B	Y	
		LEF	13 x 8 1/4"	N	N	N	N	
	Plain Paper	8 Kai	SEF	267 x 390	N	N	N	N
		16 Kai	SEF	195 x 267	C	N	C	Y
			LEF	267 x 195	N	N	N	N
Envelope	Com10	SEF	4 1/8 x 9 1/2"	B	N	B	N	
	Monarch	SEF	3 7/8 x 7 1/2"	B	N	B	N	
	C6	SEF	114 x 162	B	N	B	N	
	C5	SEF	162 x 229	B	N	B	N	
	DL Env	SEF	110 x 220	B	N	B	N	
Custom		Width	90-216mm (3.54 x 8.50")	C	N	C	N	
		Length	148 – 356mm (5.83 x 14.02")	C	N	C	N	

**APPENDICES:**  
**PREVENTIVE MAINTENANCE**

<b>REVISION HISTORY</b>		
<b>Page</b>	<b>Date</b>	<b>Added/Updated/New</b>
		None



## 2. APPENDICES: PREVENTIVE MAINTENANCE

### 2.1.1 USER REPLACEABLE ITEMS

Item	Yield	Note
Waste Toner Bottle	Approx. 25 k prints/ bottle (See condition 4)	Image Coverage Ratio: 5%, BK:CMY=5:5
AIO BK (1.8k)	Approx. 2.0 k prints/cartridge	For M199/ M199 *Except for NA
AIO CMY (1.4k)	Approx. 1.6 k prints/cartridge	
AIO BK (2.0k)	Approx. 2.3 k prints/cartridge	For M199/ M203 (NA only)
AIO CMY (2.0k)	Approx. 2.3 k prints/cartridge	
AIO BK (3.6k)	Approx. 4.5 k prints/cartridge	For M204/ M200
AIO CMY (3.4k)	Approx. 4.0 k prints/cartridge	
AIO BK (5k)	Approx. 6.5 k prints/cartridge	For M204 / M200
AIO CMY (5k)	Approx. 6.0 k prints/cartridge	

#### Condition:

1. The condition is standard temperature and humidity.
2. These yield values may change depending on the circumstances and printing conditions.
3. The Waste Toner Bottle's yield is measured when the printer is used 50% for color and 50% for black-and-white
4. Waste Toner Bottle yield was measured for 3P/J when the printer is used 50% for color and 50% for black-and-white.

## 2.1.2 YIELD ITEMS AND SERVICE MAINTENANCE

The machine default setting will show the messages “Replace Soon” at the near end condition and “Replace Now” at the end condition for yield parts. However, you can select the preferred machine action at near end and end for yield parts using SP mode “PM Parts Rep Notice” as shown in the following table.

There are 4 settings (0 to 3):

PM Parts Rep Notice	Sets whether to display the PM parts replacement notice and whether to stop the engine.	
	0	At near end: No Notice / Not Stopped
		At life end: Notice “Replace Now” / Not Stopped
	1	At near end: No Notice / Not Stopped
		At life end: No Notice / Not Stopped
	<b>2 (default)</b>	At near end: Notice / Not Stopped
		At life end: Notice “Replace Now” / Not Stopped
	3	At near end: Notice “Replace Soon” / Not Stopped
At life end: Notice “Replace Now” / Stopped		

Item	Yield
Image Transfer Unit	90 K
Fusing Unit	90 K
Transfer Roller	90 K

## 2.2 EXCHANGE AND REPLACE PROCEDURE

If the machine exchange and replacement is required, arrange to send a machine without the four print cartridges (AIO) to the customer site.

### 2.2.1 INSTRUCTION

Instruct the customer to do the following procedure.

#### **Before the substitute machine gets to the customer site**

- Save the customer settings by using a web browser. For details, refer to the “User Guide”.
- Clear customer settings in the problem machine.

#### **When the substitute machine gets to the customer site**

1. Remove the four print cartridges (AIO) from the problem machine.
2. Install the four print cartridges (AIO) into the substitute machine.
3. Restore the customer settings which are printed on the configuration page by using a web browser.
4. Send back the problem machine to the repair center.

## 2.2.2 CLEANING POINTS AFTER MACHINE ARRIVAL AT DEPOT

1. Open the front cover.

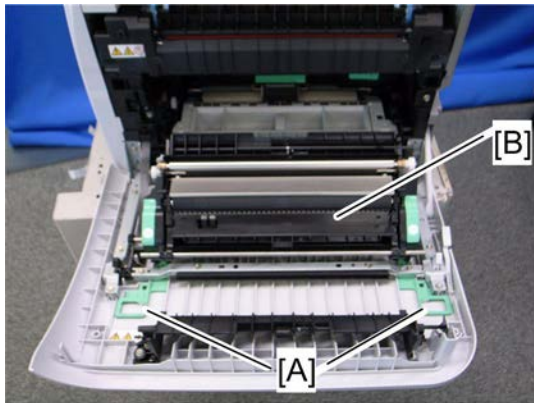

2. Release the locks [A].
3. Transfer unit [B]

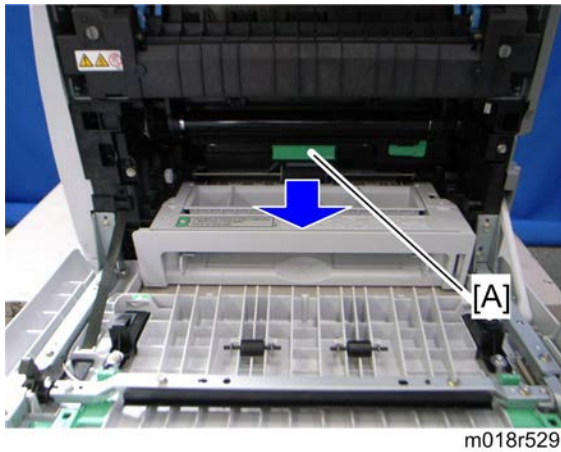

4. Pull out the waste toner bottle [A].

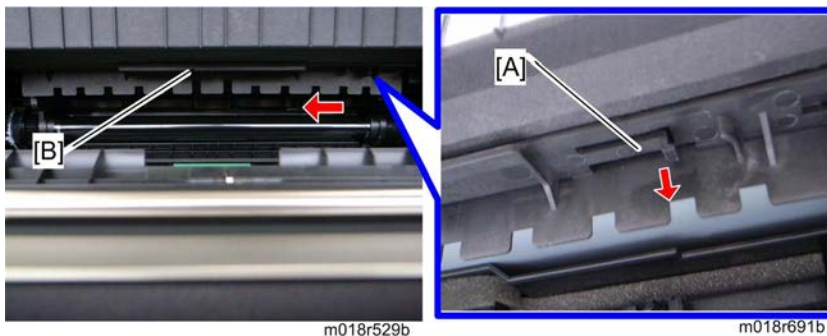

5. Release the hook [A] under the guide plate.
6. Move the guide plate [B] underneath the fusing unit to the left, and then remove it.

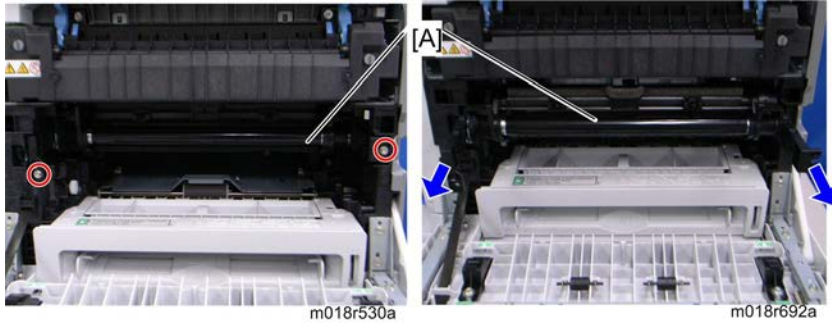

7. Pull out the image transfer belt unit [A] (  x 2).

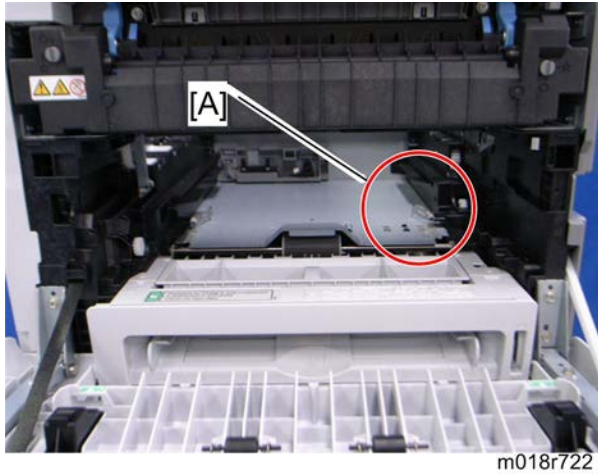

8. Clean inside the printer, especially around the circled area [A].

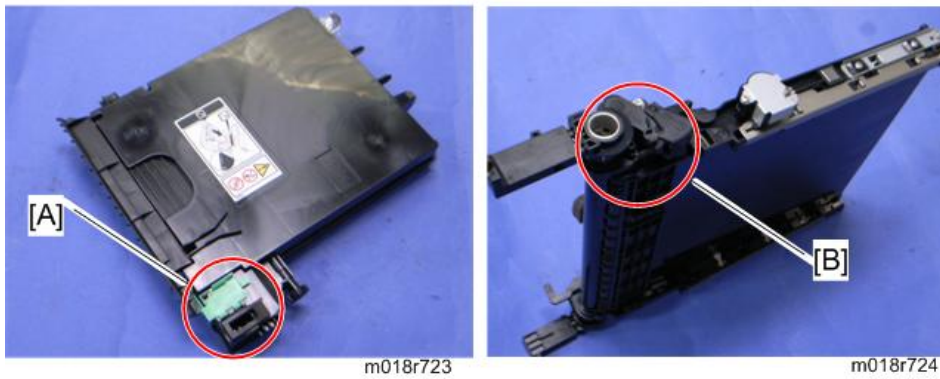

9. Clean the circled area at the waste toner bottle [A] and circled area [B] at image transfer belt unit.
10. Reassemble the printer.

## 2.3 FAQs/KNOWLEDGE BASE

You can access the FAQs and knowledge base for this model through Web Image Monitor.

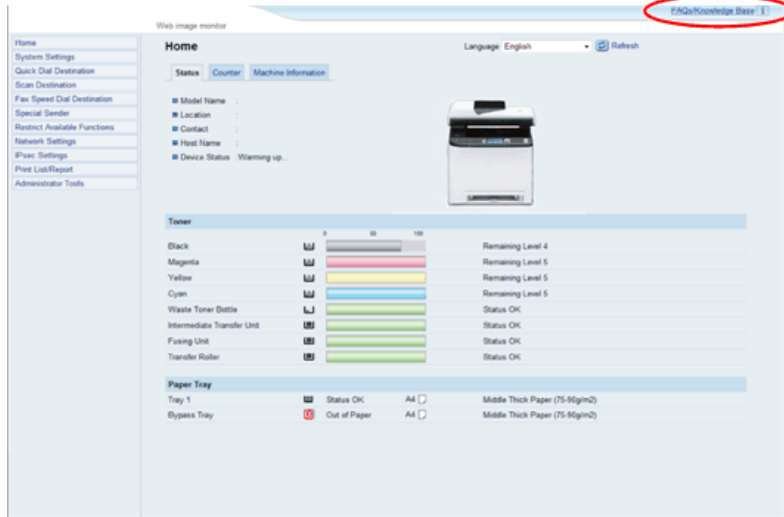

m204f0001

1. [http://machine's\\_IP\\_address](http://machine's_IP_address)
2. Click 'FAQ/Knowledge Base' at the top right of the screen.
- 3.

# **PAPER FEED UNIT TK1010 (G849)**

<b>REVISION HISTORY</b>		
<b>Page</b>	<b>Date</b>	<b>Added/Updated/New</b>
		None

# PAPER FEED UNIT TK1010 (G849)

## TABLE OF CONTENTS

<b>1. REPLACEMENT AND ADJUSTMENT.....</b>	<b>1</b>
1.1 PAPER FEED UNIT .....	1
1.1.1 TOP COVER.....	1
1.1.2 PAPER FEED AND RELAY CLUTCH .....	1
1.1.3 PAPER END AND RELAY SENSOR.....	2
1.1.4 PAPER FEED ROLLER.....	3
When reassembling.....	4
1.1.5 FRICTION PAD.....	5
When reassembling.....	5
<b>2. DETAILED SECTION DESCRIPTIONS .....</b>	<b>7</b>
2.1 OVERVIEW.....	7
2.1.1 COMPONENT LAYOUT .....	7
2.2 BASIC OPERATION .....	8
2.2.1 PAPER SEPARATION AND FEED.....	8
2.2.2 PAPER LIFT .....	9
2.2.3 PAPER END DETECTION.....	10



# Read This First

## Safety and Symbols

### Replacement Procedure Safety

#### **CAUTION**

- Turn off the main power switch and unplug the machine before beginning any of the replacement procedures in this manual.

#### Symbols Used in this Manual

This manual uses the following symbols.

\*: See or Refer to

: Screws

: Connector

: Clip ring

: E-ring

# 1. REPLACEMENT AND ADJUSTMENT

## 1.1 PAPER FEED UNIT

### 1.1.1 TOP COVER

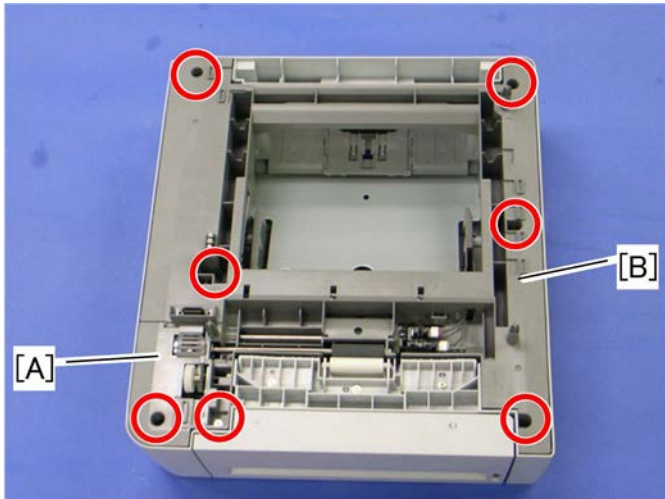

g849r501

1. Top left cover [A] (🔩 x 1)
2. Top cover [B] (🔩 x 6)

### 1.1.2 PAPER FEED AND RELAY CLUTCH

1. Top cover (\* Top Cover)

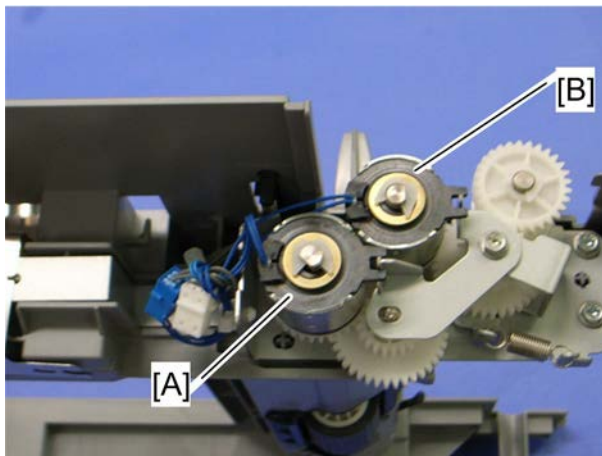

g849r504

2. Paper feed clutch [A] (🔩 x 1, 🛠️ x 1)
3. Relay clutch [B] (🔩 x 1, 🛠️ x 1)

## Paper Feed Unit

### 1.1.3 PAPER END AND RELAY SENSOR

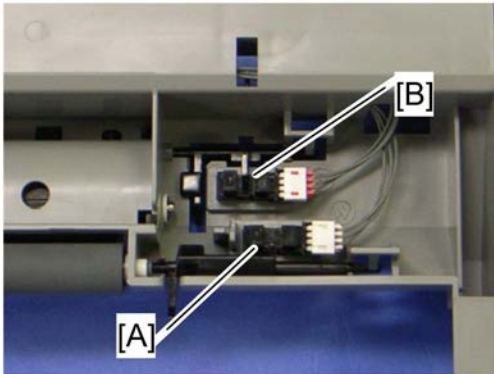

1. Top cover (\* Top Cover)

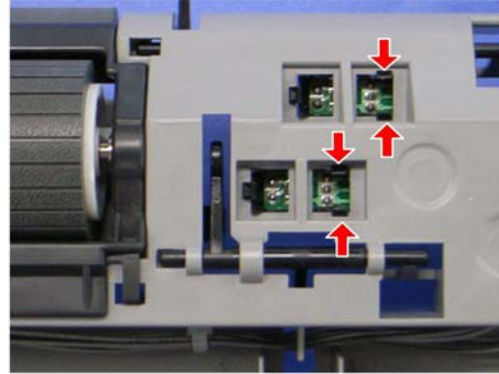

g849r505



g849r506

2. Paper end sensor [A] (hooks,  x 1)
3. Relay sensor [B] (hooks,  x 1)

### 1.1.4 PAPER FEED ROLLER

1. Top cover (\* Top Cover)
2. Paper feed clutch (\* Top Cover)

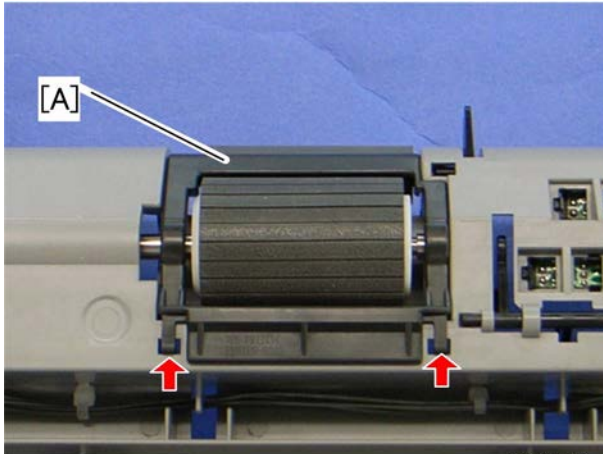

g849r502

3. Paper guide [A] (hooks)

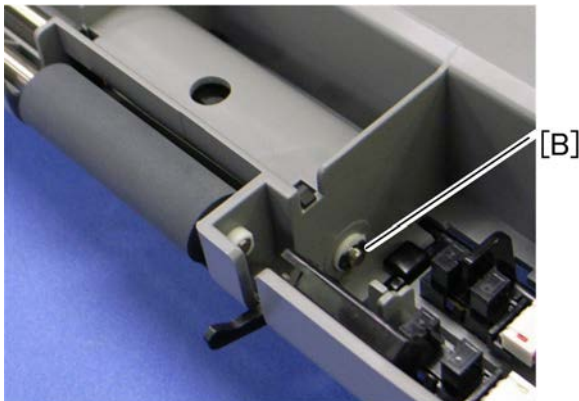

g849r503

4. Remove the e-ring [B] at the right edge of the feed roller shaft.

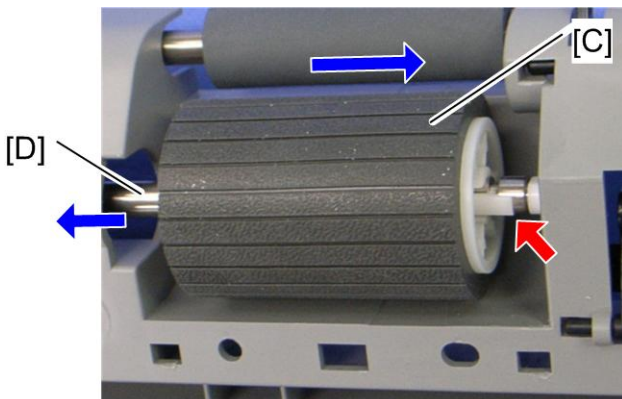

g849r506

5. Slide the paper feed roller [C] to the right side (hook).
6. Pull out the feed roller shaft [D] to the left side (bushing x 1).

## Paper Feed Unit

### ***When reassembling***

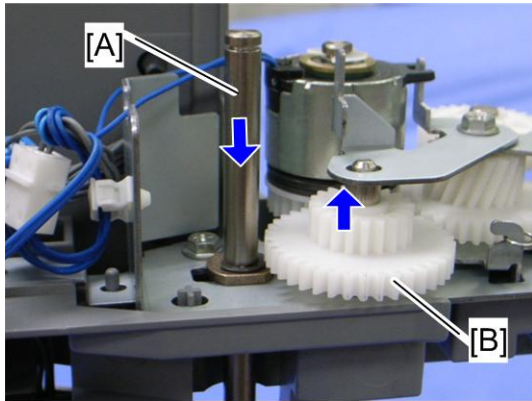

If the feed roller shaft [A] cannot be inserted easily, pull the gear [B], and then insert the feed roller shaft.

### 1.1.5 FRICTION PAD

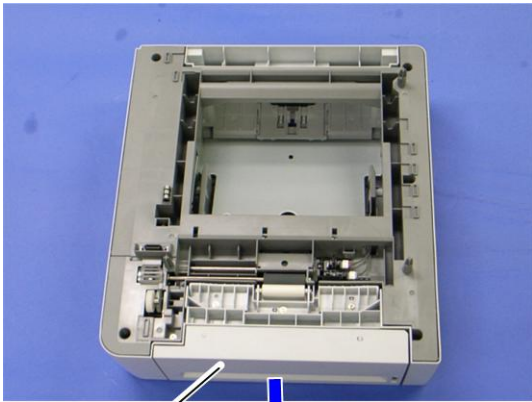

g849r501a

1. Pull out the tray [A]

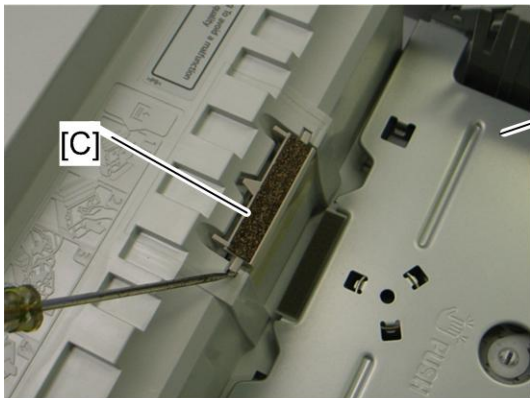

g849r508

2. Press down the bottom plate [B]
3. Friction pad [C] (hooks, spring x 1)

#### ***When reassembling***

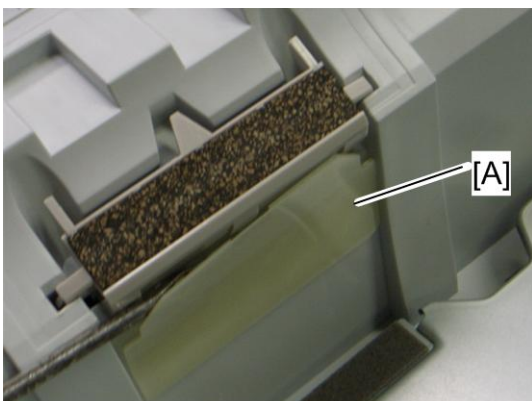

g849r509

When re-installing the friction pad, make sure that the mylar [A] does not go under the friction pad.

## 2. DETAILED SECTION DESCRIPTIONS

### 2.1 OVERVIEW

#### 2.1.1 COMPONENT LAYOUT

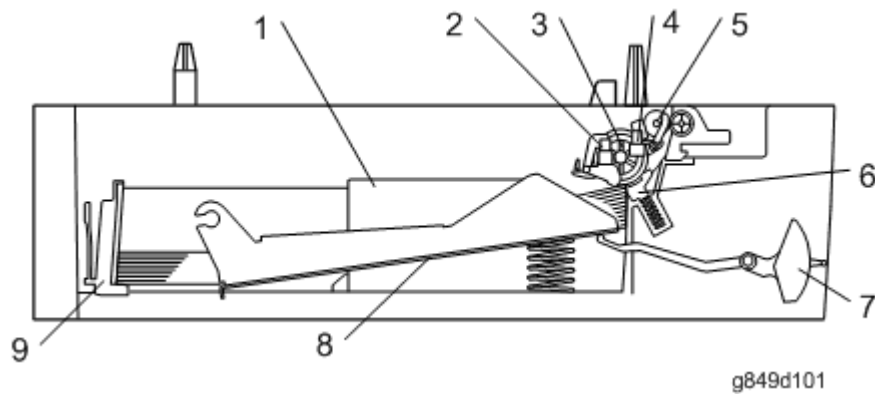

1. Side Fence	6. Friction Pad
2. Paper End Sensor	7. Paper Height Lever
3. Paper Feed Roller	8. Bottom Plate
4. Relay Sensor	9. Rear Fence
5. Relay Roller	

## 2.2 BASIC OPERATION

### 2.2.1 PAPER SEPARATION AND FEED

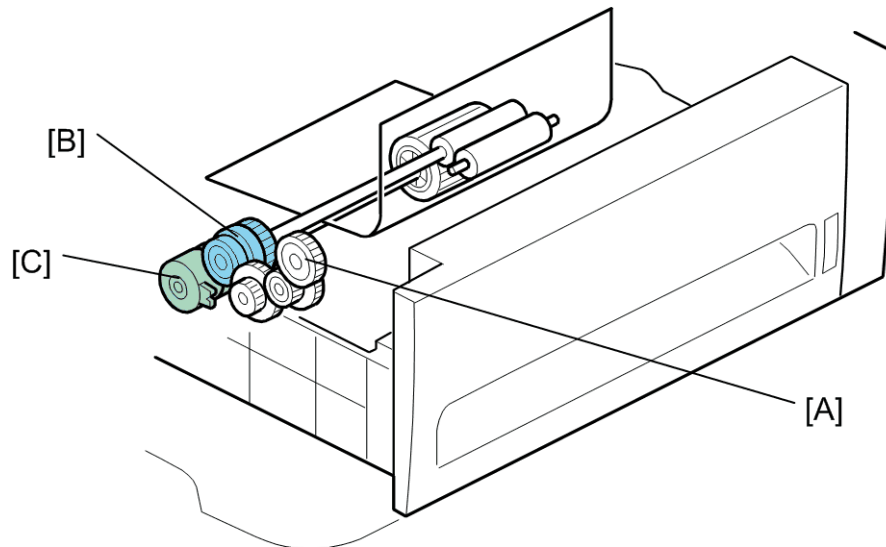

g849d102

The paper tray holds 500 sheets of paper.

The paper feed unit uses a friction pad system.

The gear [A] is driven by the transport/fusing motor in the mainframe.

The relay clutch [B] and paper feed clutch [C] control drive from the mainframe. When the optional tray is selected as the feed tray, the relay clutch and paper feed clutch transmit drive power to the relay roller and paper feed roller.



## 2.2.2 PAPER LIFT

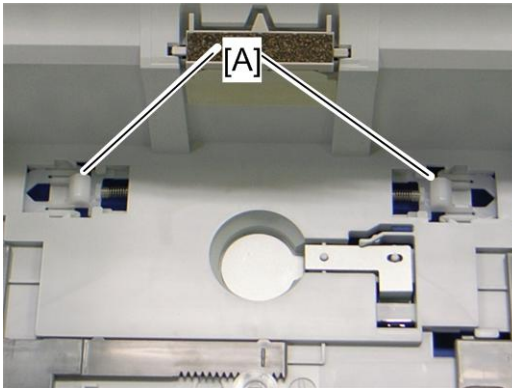

g849d501

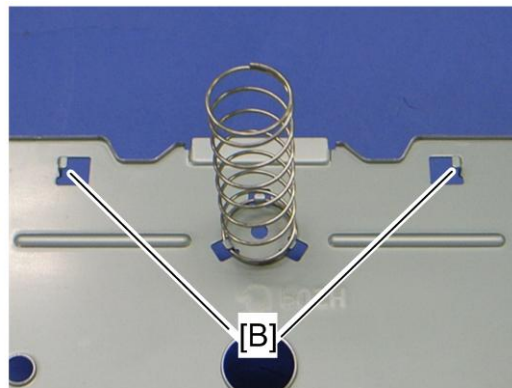

g849d502

The bottom plate is always pressed up by the spring in the tray. Therefore, you must press down the bottom plate when you insert the tray in the machine.

The bottom tray lock levers [A] hold the tabs [B] under the bottom plate after the bottom plate is pressed down.

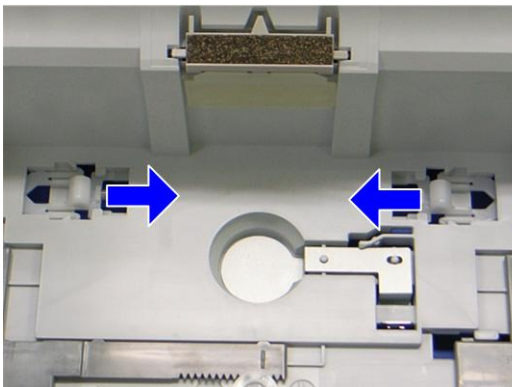

g849d501

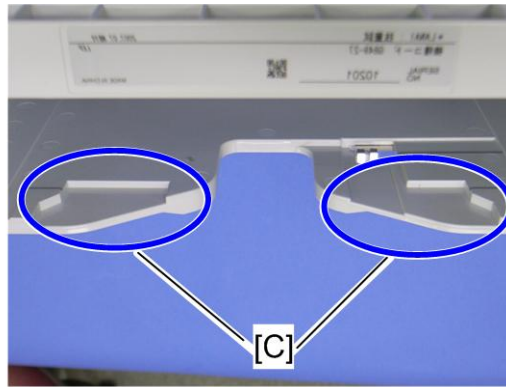

g849d503

When the tray is inserted in the machine, the lock lever guides [C] in the paper feed unit push the bottom plate lock levers, and then the lock levers release the tabs under the bottom plate. As a result, the bottom plate is lifted by the spring.

## 2.2.3 PAPER END DETECTION

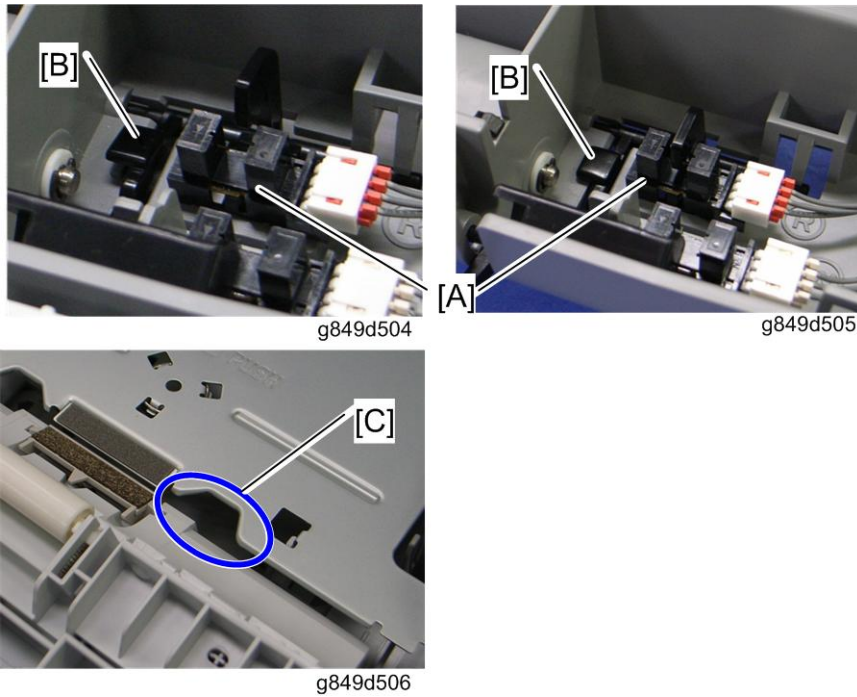

There is a paper end sensor [A] in the tray. The feeler [B] drops into the cutout [C] in the bottom plate and the actuator interrupts the paper end sensor. This sensor also detects whether the tray is set.